

BeoLink®

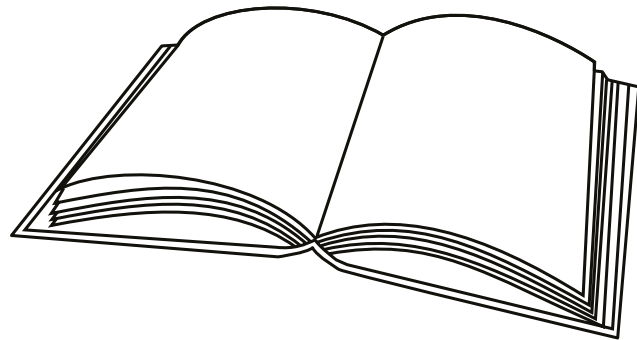

Handbook
English - version 1.9



BANG & OLUFSEN

Navigation in this handbook

When the guide is opened, it automatically opens in Full Screen Mode (can be left as desired - see below). This is primarily done to optimise the usability of screen reading. There are several ways to navigate when using the guide, see the survey of keys, shortcuts and hot keys below:

 (arrow keys on the keyboard) navigates to the next page
 (arrow keys on the keyboard) navigates to the previous page

 (Esc button) exits Full Screen Mode
 (press **Ctrl + L** to return to Full Screen Mode).

Another feature to optimise the navigation is the navigation icons in the bottom of the screen (see below for explanation).

 Navigates you to the previous view

 Navigates you directly to the start page

 Navigates directly to the table of contents (these are active links - click the link to be directed directly to the associated section)

 Prints the document - the print dialogue box opens
 (Ctrl + P also brings up this feature)

Furthermore, to ease the navigation, this guide contains links. The links are mouseover active and marked with blue text. Just click on a page reference to be transferred to that page.

Navigation TIP

The right side of this page acts as an active table of contents. The and the Table of Contents [page 181](#) is more detailed. Simply click the subject you want and you are transferred to the section in question.

Navigation in this handbook
How to use this handbook
BeoLink
Master Link
Network Link
Power Link
Audio Distribution / Video Distribution
Multiroom
Home Automation
One-remote
PUC
Active Infrastructure
Passive Infrastructure
Troubleshooting
Questions & Answers
General Terms - definitions
Glossary & Abbreviations
Index
Table of Contents

How to use this handbook

The BeoLink Handbook is to be used in planning and supporting the completion of system solutions to the customers. This may have particular interest to dealers and installers.

The handbook may be used as an encyclopedia, e.g. supported by looking up subjects in the Index; see [page 176](#), and/or the Table of Contents; see [page 181](#).

Attention is made to the General Terms - definitions [page 167](#).

Different symbols are used in the handbook to illustrate the audio products, video products, loudspeakers etc. Unless otherwise mentioned in the text, these symbols should be taken as examples for the category only.

As the handbook put special emphasis on the basic rules for installation, only the common features of the products are mentioned.

Main sections

The main sections in this handbook are seen from the "[Navigation in this handbook](#)" on [page 2](#), and the "[Table of Contents](#)" on [page 181](#). Each section is dealing with: - an overall introduction, - scenarios when appropriate and - related products.

Active Infrastructure

Dealing with: - two fundamental network scenarios; - router setup; - setting up access points, - wireless limitations; - Extending the LAN; - AP placement; - coverage and connections; - channel selection/planning; - wireless survey; - ISP interfacing.

Passive Infrastructure

Dealing with: - cable management/handling; - installation principles; - option programming; - Tools; - Test tools; - Master Link cables; - Network Link cables; - Power Link cables; - other cables; - connectors / jacks / plugs / sockets; - conduits and cable trays; - Installation accessories; - junction boxes; - cabinets; - patch modules; - brackets for cabinets; - brackets for 19" racks; - Power Link adaptors; - Various devices; - Assembly of connectors.

Supporting handbook sections

The BeoLink handbook also includes the following supportive sections: - Troubleshooting; - Questions & Answers; - General Terms - definitions; - Glossary & Abbreviations; - Index; - Table of Contents.

Index

An index is placed at the end of this handbook, and can be used to jump to the subjects of interest via the embedded hyperlinks.

Omissions / Master Link Handbook

Link systems not used in new products are the Master Control Link (MCL) that is covered in the former Master link Handbook. This handbook will persist as an available document via BeoWise.

BeoLink - an overall introduction

BeoLink is a concept developed by Bang & Olufsen that covers the method used for linking Bang & Olufsen products together in one system controlled by one remote control. Today it includes three different technologies; the analogue Master Link system and the digital Network Link system and Power Link used with speakers. No matter which link system is used we can offer a converter that ensure it works as one system.

BeoLink Multiroom is a natural part of the BeoLink concept. Since 1982 distribution of audio between Bang & Olufsen products has been and still is an important part of the offering - this also include a well thought through operation of the entire system.

By introducing BeoLink SmartHome total integration between AV products and smart devices like intelligent light switches, thermostat regulation, shade control, surveillance cameras etc. we can offer a natural and easy-to-use system solution for your home. Even monitoring remotely is self-evident.

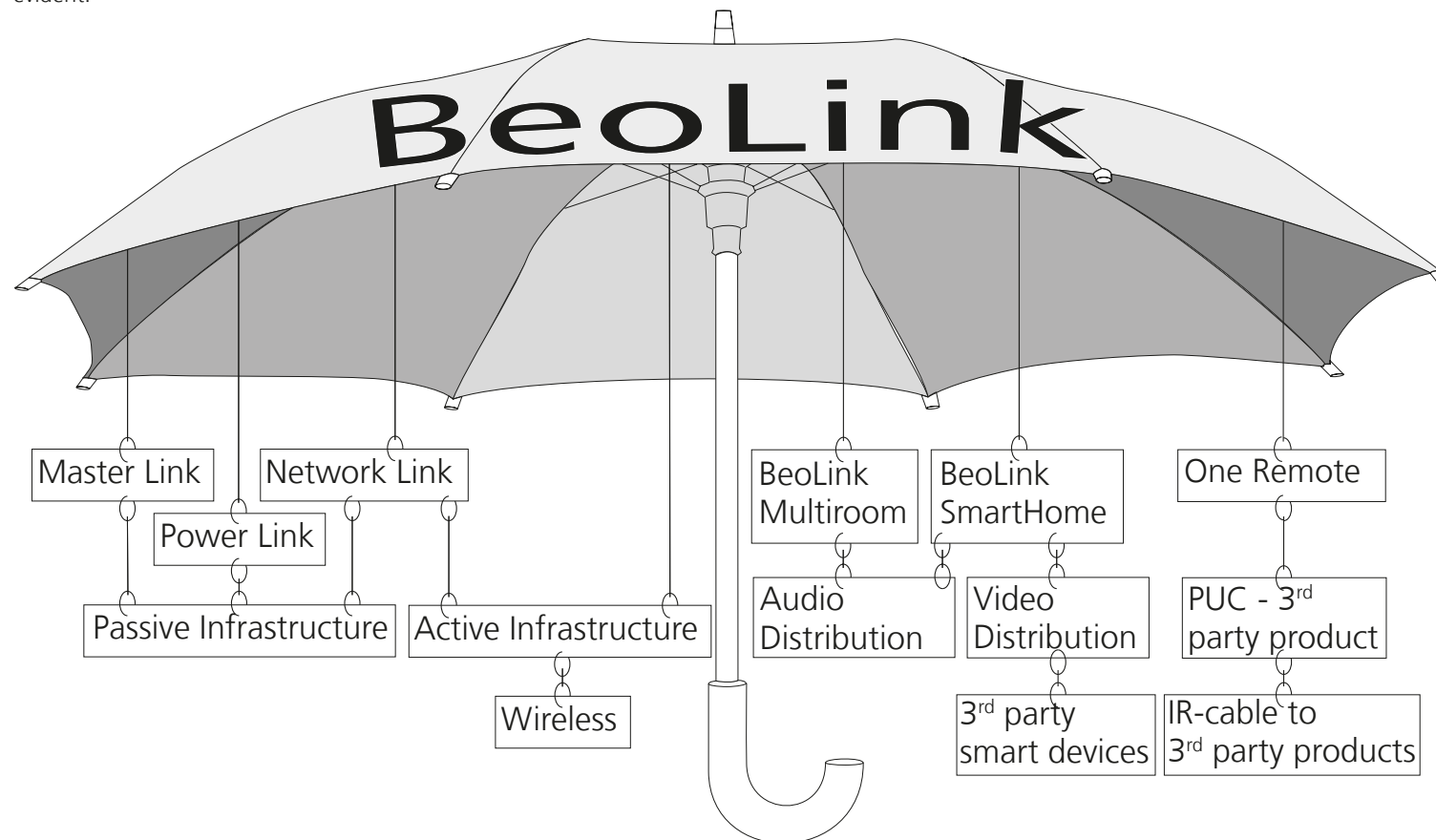

When using this document interactively, the signs under the umbrella acts as links to the appropriate sections in this BeoLink Handbook.

BeoLink® is a registered trademark of Bang & Olufsen a/s

Provided advantages

BeoLink provides solution concepts that includes a lot of advantages such as:

- BeoLink Multiroom - based on:
 - One remote control of all connected devices.
 - 3rd party devices controlled by built-in Peripheral Unit Control (PUC) - see also [page 51](#).
 - Sound distribution to multiple rooms around the house + distribution of video by the use of an HDMI switch matrix to multiple TVs around the house including distribution of various connected sources.
Access to sources, connected in one room, from another room (Join/listen in).
Echo free listening simultaneously (party mode).
 - Compatibility that makes our solutions technically independent.
- BeoLink SmartHome comprising:
 - Control of third party devices, both in the A/V world and from home automation systems.
 - Integration to existing control systems like: Crestron, AMX, Savant, Control4, RTI, etc.
- "Smooth Installation" principles comprising:
 - Installation of control systems based on predefined interfaces and commands.
 - Open IP interface for integration.



Control of products

Controlling products means more than just controlling the Bang & Olufsen products set up in the BeoLink network. It embraces the control of 3rd party sources providing the audio and video experience via Peripheral Unit Control (PUC). This can be sources connected directly to the Bang & Olufsen products or distributed e.g. via an HDMI switch matrix.

One-remote - all at the hand

And even more! On top of the A/V-experience Bang & Olufsen provides full integration with a multitude of Home Automation systems by adding a BeoLink Gateway. Consequently it is then possible to e.g.:

- Control the natural light, (shades, curtains, and blinds),
- Control the artificial light,
- Control magic makers such as: Lifting TV, loudspeakers, projectors, screen, volume, light level, climate control, security systems, pool covers etc.
– almost anything is possible.

Magic, surprise, tranquillity, believable

To complete the magical experience, all the above can also be controlled by a dedicated Bang & Olufsen app – called the BeoLink App. This is operated from an iOS based device and providing possibilities such as:

- Customized user interface (UI) of BeoLink App.
- Selecting TV and radio channels,
- Access to all home automated devices - i.e. whole home control and monitoring e.g. by adding a door camera - to be viewed on the device running the BeoLink App or on a TV screen,

(BeoLink App control requires a BeoLink Gateway in the home and an internet connection from where it is operated).

This can give customers “scene setting” such as: coming home; leaving home, cinema, music, dining, relaxing, party, romantic - and covers all from light, audio and video etc.

Apps

Apps are useful extensions to the Beo remote control, and the following apps are available:

- BeoLink App for controlling the Bang & Olufsen Audio and Video products and all home automation product linked by the BeoLink Gateway.
- BeoRemote App is focusing on TV operation and connects video sources.
- BeoMusic App is focusing on audio experiences including BeoLink Multiroom.
- BeoSetup App is used by installers doing customer installations.

See also about One-remote on [page 50](#).

Master Link - an overall description

Master Link is a well-known and well proven solution provided and developed by Bang & Olufsen for connecting products in a larger system. Since 1992 the Master Link concept has been the Bang & Olufsen audio and video distribution system. The Master Link system has been improved over the years and will probably remain as part of installations for many years ahead.

Master Link has the ability to distribute both audio and video signals. In the Master Link system audio and control signals are distributed using a single cable, while the distribution of video signals requires an additional aerial network realized by coax cable.

Master Link system uses a bus-type connection running in Master Link cables. Master Link handles all links, i.e. control signals both between the audio/video systems in the main room and between the main room and link rooms.

Master Link signals are distributed as balanced signals, making it possible to distribute audio signals in CD sound quality, even over long cable distances; see [page 79](#).

Distribution of analogue video signals takes place in additional coax cables in analogue cable TV quality. Video signals are distributed from the main room to the link room(s). Digital video signals are distributed using an HDMI switch matrix solution; see [page 35](#).

Volume adjustment and tone control in all link rooms are totally independent which is provided by the distribution of audio signals at line level and the use of a power amplifier in each individual link room.

To ensure compatibility between Master Link based products and Network Link based products they can coexist and are integrated by the use of BeoLink Converter NL/ML and the NL/ML Delay Box; see the section about Network Link [page 21](#).

Video signals are distributed by the use of a switch matrix, and is an additional possibility to the Master Link setup; see [page 35](#), and separate Installation Guide.

Principles of a Master Link setup:

- Products are connected to each other using Master Link cables.
 - Master Link cables are assembled with the Master Link Junction Box and/or the Master Link Distributor.
 - Cat 7 cables are connected in the Patch Modules and Network Link Brackets; see [page 136](#).
 - Master link cables can also be distributed using the Network Link infrastructure; see examples [page 86](#).
 - Option programming of the products are described in details in [page 90](#).
-

Master Link Scenarios

ML scenario 1
- Audio only

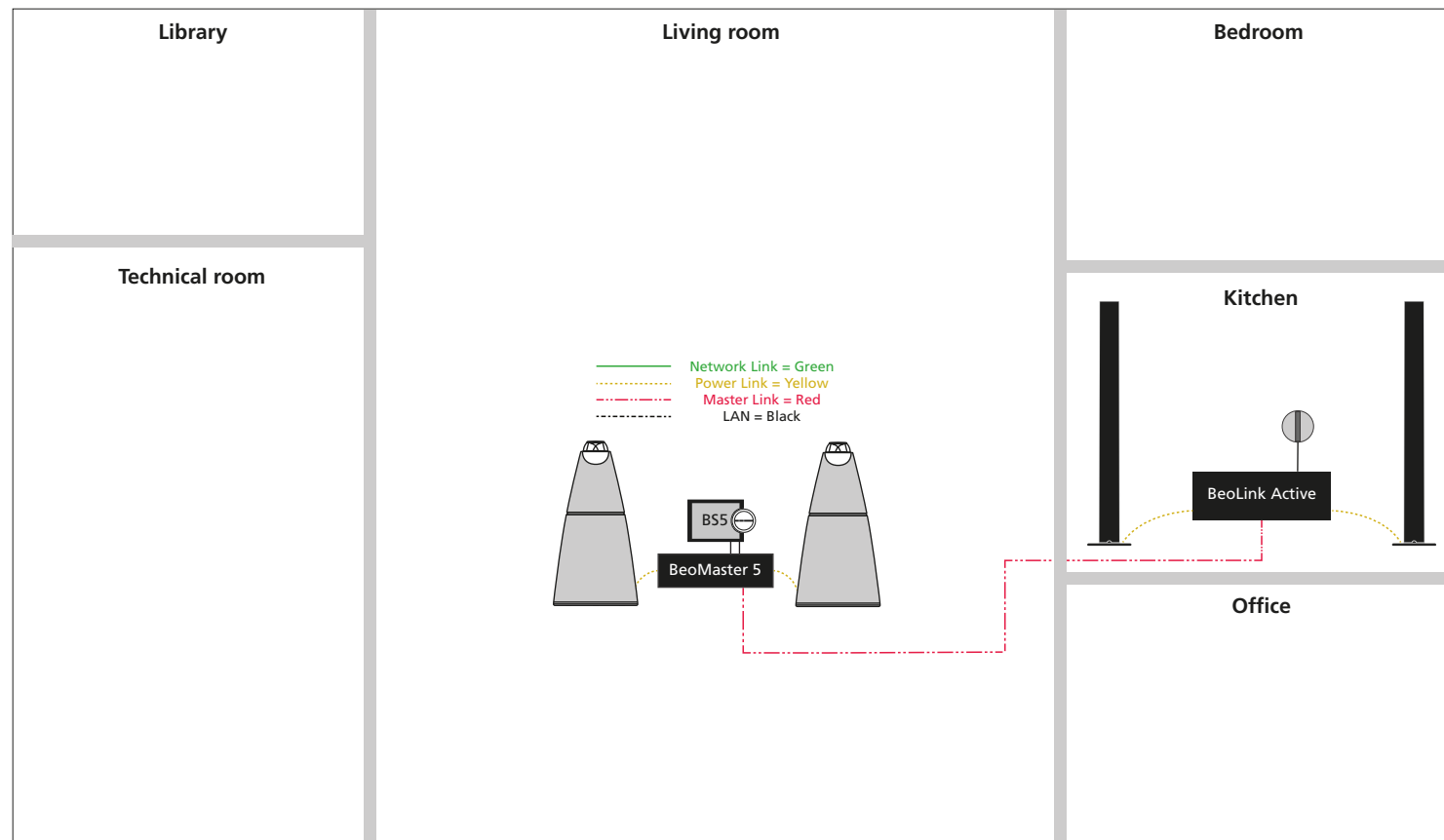

Audio (only) in main room and audio in link room

	BeoSound 5 Living room	BeoLink Active Kitchen
Option	1 or 2	6

ML scenario 2
- Video only

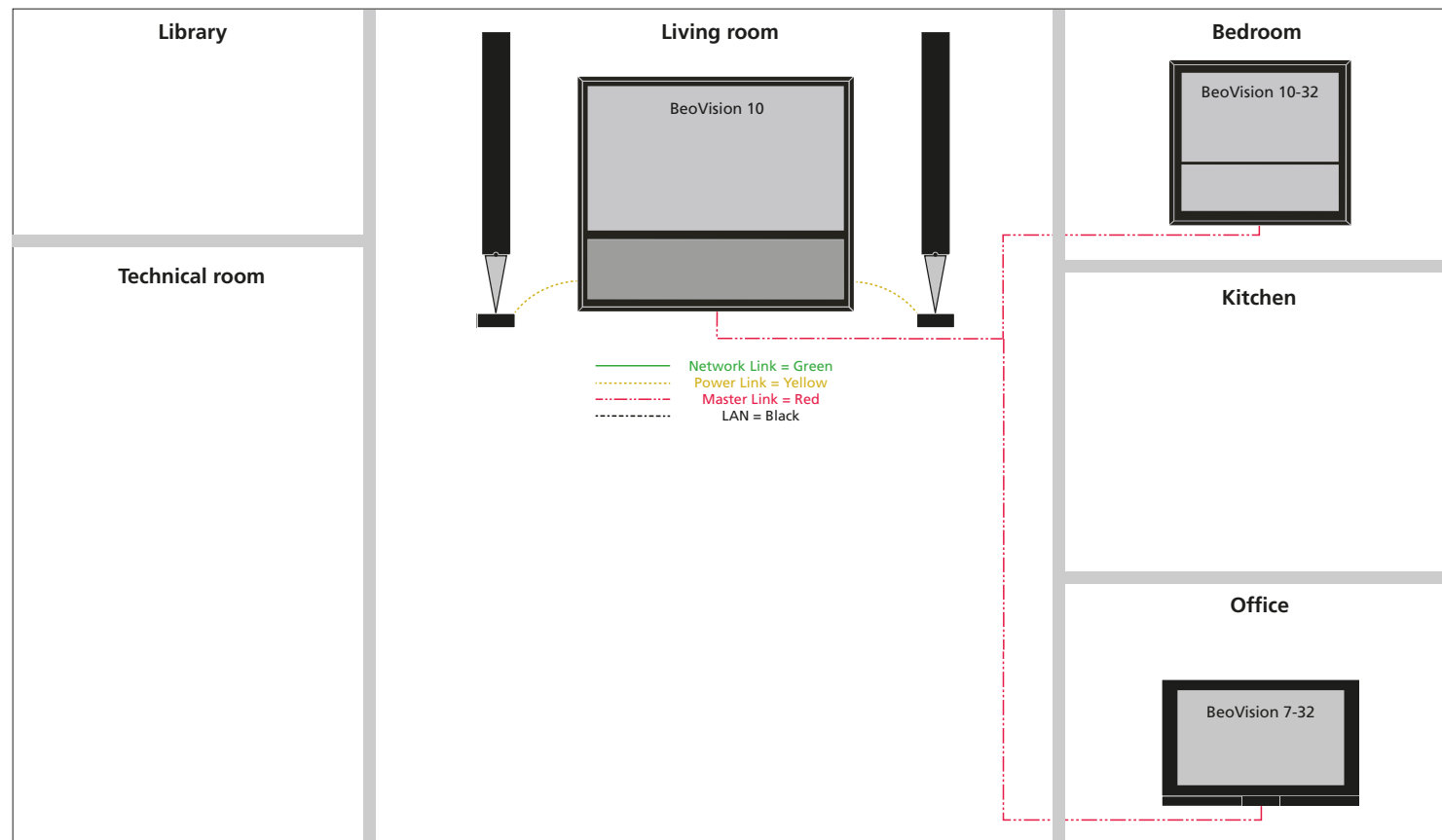

Video (only) in main room and video in link rooms.

	BeoVision 10 Living room	BeoVision 10 Bedroom	BeoVision 7 Office
Option	1 or 2	6	6

ML scenario 3
- Video and Audio in main room

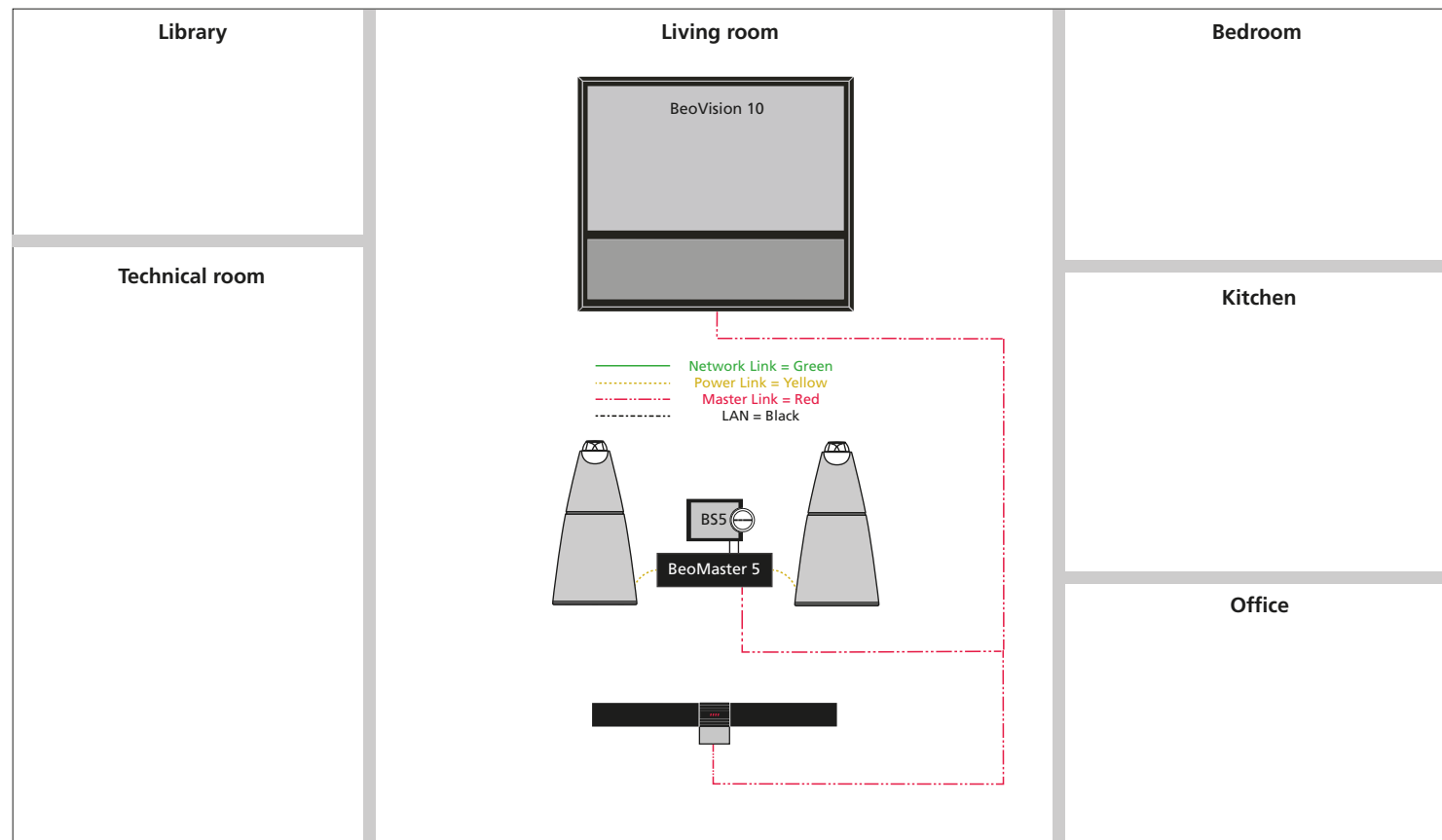

Audio and video in main room and link product in same room.

	BeoSound 5 Living room	BeoVision 10 Main room	BeoLab 3500 Main room
Option	1	1	4 *

* When a BeoLink "link" product is used in surroundings with other products and the remote control signals can be reflected by the walls, the "link" product is set in option 4 and the Beo4 can be set in constant Link mode; see [page 92](#).
First press **Link** and next press the source button to operate the setup via the "link" product.
See more about option 4 setting [page 90](#) and [page 91](#).

ML scenario 4
- Video and Audio in main room and link rooms

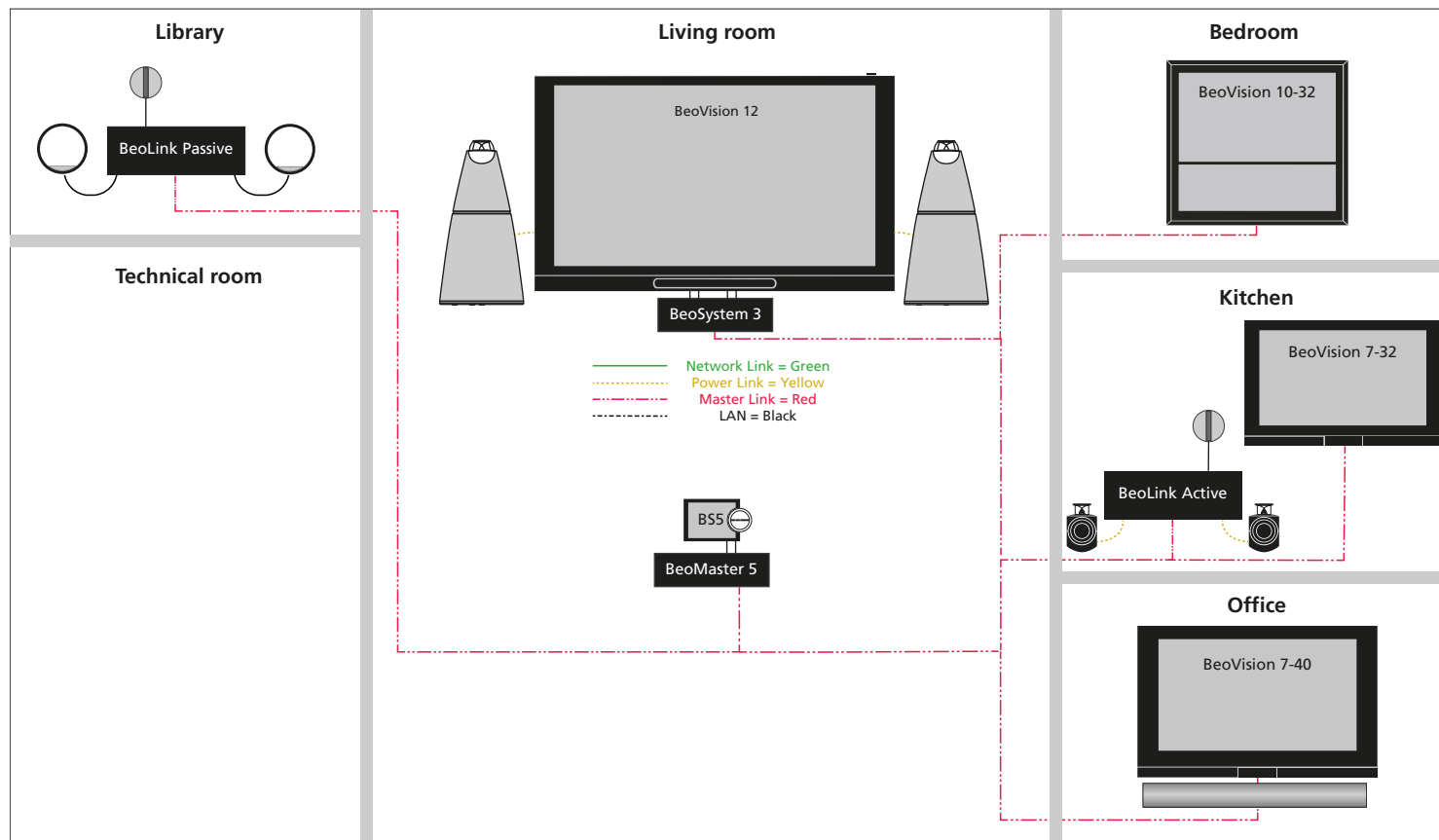

Audio and video in main and audio and video in link rooms.

	BeoVision 12-65 BeoSystem 3 Living room	BeoSound 5 Living room	BeoLink Passive Library	BeoVision 10 Bedroom	BeoVision 7 Kitchen	BeoLink Active Kitchen	BeoVision 7 Office
Option	2	0	6	6	5	5	6

ML scenario 5
 - Audio in main room
 (living room) and
 video in main room (bedroom)

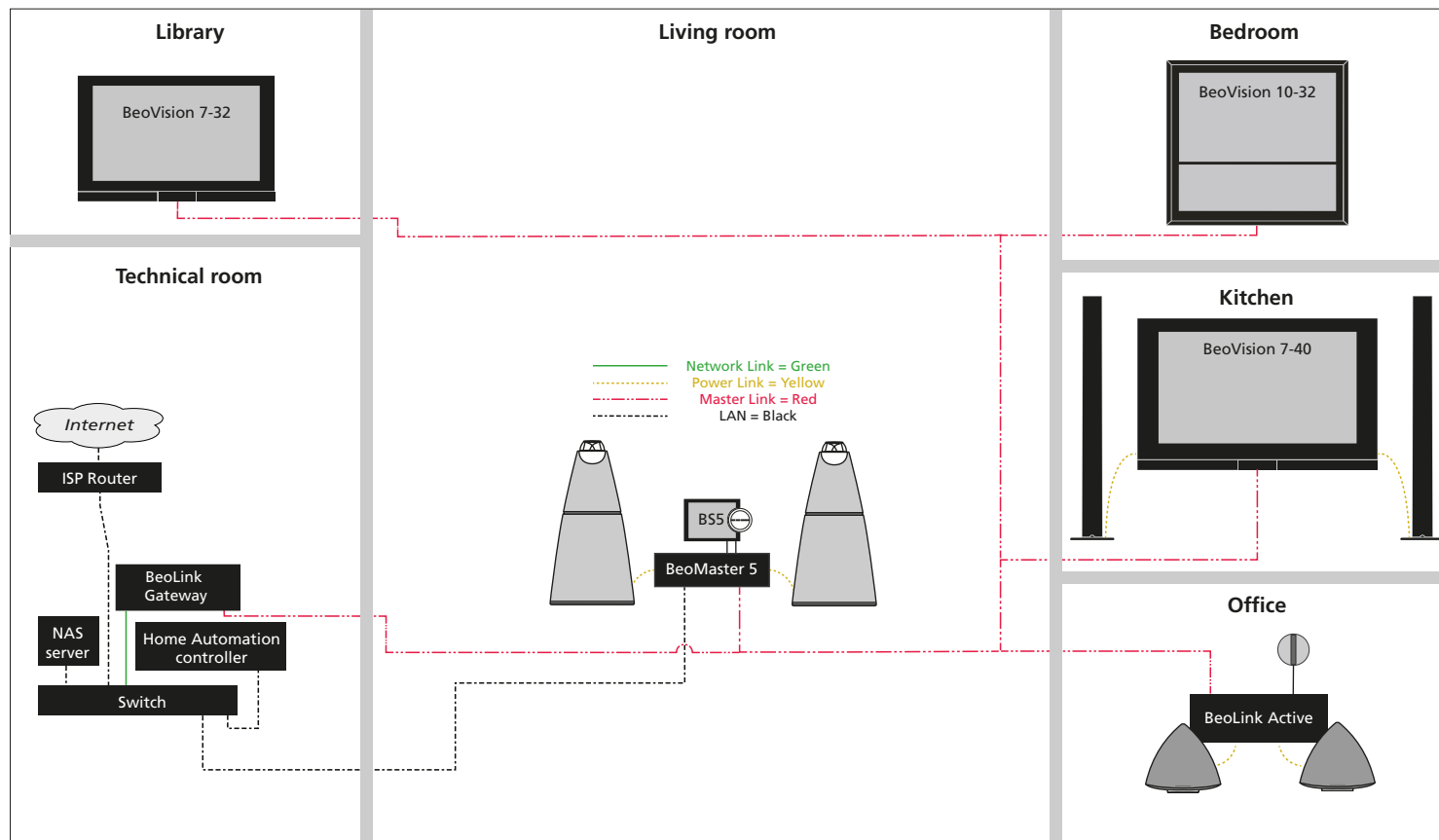

Audio in living room (main), video in kitchen (main) room (= two room), other rooms behaves as link rooms.

	BeoSound 5 Living room	BeoVision 7 Library	BeoVision 10 Bedroom	BeoVision 7 Kitchen	BeoVision 10 Office
Option	2	6	6	2 *	6

Master Link - link products

Below you can find descriptions of the Master Link products and their included accessories supplied, together with details of how they are used.

BeoLab 3500

Contents

BeoLab 3500 is an integrated active link room loudspeaker with right and left sound channels. BeoLab 3500 has a Master Link (ML) connection, IR receiver and display.

BeoLab 3500 is supplied with a mains cable and fittings for wall mounting.

Use

BeoLab 3500 is used in link rooms where an integrated active loudspeaker is to be used. BeoLab 3500 makes it possible to listen to sound from any audio master and video master product in the main room.

BeoLab 3500 has a built-in sound control circuit, allowing volume and sound adjustment to be performed individually in relation to the main room.

The sound adjustment facilitates individual adjustment of balance, bass, treble and loudness.

BeoLab 3500 has the following local control options:

- Timer On/Off and wake-up timer
- PLAY / ST.BY

Part number

Part No.	Product
1160111	EU; BeoLab 3500 w wall mounting kit and 3 m / 10 ft mains cable
1160211	GB; BeoLab 3500 w wall mounting kit and 3 m / 10 ft mains cable
1160311	USA/CDN; BeoLab 3500 w wall mounting kit and 3 m / 10 ft mains cable
1160411	JPN; BeoLab 3500 w wall mounting kit and 3 m / 10 ft mains cable
1160511	AUS; BeoLab 3500 w wall mounting kit and 3 m / 10 ft mains cable
1160711	KOR; BeoLab 3500 w wall mounting kit and 3 m / 10 ft mains cable
1160811	CN/HK; BeoLab 3500 w wall mounting kit and 3 m / 10 ft mains cable
Option	
1160611	Table stand for placement in flat surface, shelf/table

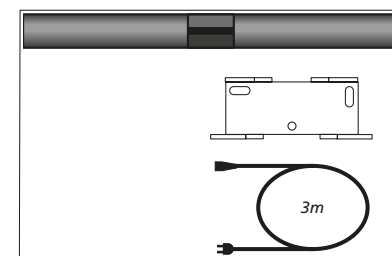

Miscellaneous

In addition to the accessories supplied, the installation may require a Master Link cable (see [page 97](#)), plugs (see [page 126](#)), and junction boxes (see [page 133](#) and [page 134](#)).

BeoLink Active

Contents

BeoLink Active consists of a control box, an IR receiver, a mains cable and a cable to the IR receiver. The 5 m /16 ft cable can be replaced by the low impedance IR cable 15 m / 50 ft; see [page 120](#).

Use

BeoLink Active is used in link rooms together with active loudspeakers.

Any type of Bang & Olufsen active loudspeaker can be connected. If connected to a BeoLab with one PL socket only, a Power Link Splitter Cable is also needed (see [page 112](#)), as the BeoLink Active only has one Power Link signal, and the signal cannot be looped further into the BeoLab.

BeoLink Active has a built-in sound control circuit, allowing volume and sound adjustment to be performed individually in relation to the main room.

The sound adjustment facilitates individual adjustment of balance, bass, treble and loudness.

BeoLink Active enables the listening to the sound from all the products in the main room – both video and audio sources.

By means of an 8 pin DIN male to stereo female RCA connector (see [page 116](#)), it is possible to connect to e.g. an iPod or MP3 player docking directly to the BeoLink Active in a link room and listen to your own local music source through the connected active loudspeaker to get optimal sound experience.

BeoLink Active provides the following local control options:

- Timer On/Off
- PLAY / ST.BY
- Volume adjustment.

Part number

Part No.	Product
1161666 MK I	EU; BeoLink Active w IR receiver, 5 m IR-cable and 1.5 m / 5 ft mains cable
1161866 MK I	USA; BeoLink Active w IR receiver, 5 m IR-cable and 1.5 m / 5 ft mains cable
1163666	EU; BeoLink Active w IR receiver, 5 m IR-cable and 1.5 m / 5 ft mains cable
1163766	KOR; BeoLink Active w IR receiver, 5 m IR-cable and 1.5 m / 5 ft mains cable
1163866	USA/CDN; BeoLink Active w IR receiver, 5 m IR-cable and 1.5 m / 5 ft / 5 ft mains cable
1163966	JPN; BeoLink Active w IR receiver, 5 m IR-cable and 1.5 m / 5 ft mains cable
1168166	CN/HK; BeoLink Active w IR receiver, 5 m IR-cable and 1.5 m / 5 ft mains cable

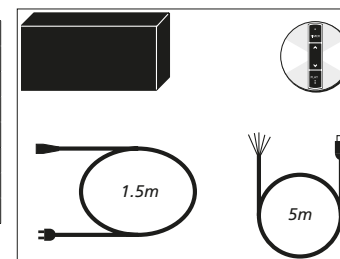

Miscellaneous

In addition to the accessories supplied, the installation also requires a Master Link cable (see [page 97](#)), plugs (see [page 126](#)), and junction boxes (see [page 133](#) and [page 134](#)).

BeoLink Passive

Contents

BeoLink Passive consists of a control box, an IR receiver, a mains cable and a cable to the IR receiver. The 5 m /16 ft cable can be replaced by the low impedance IR cable 15 m / 50 ft; see [page 120](#).

Please note the following for installation: the amplifier block is designed to operate within a room temperature range of 10 to 40°C. At temperatures outside this range it can block the whole Master Link system if connected to one.

Use

BeoLink Passive is used in link rooms together with passive loudspeakers. All Bang & Olufsen passive loudspeakers can be connected.

BeoLink Passive has built-in sound control, which means that sound and volume can be adjusted independently of the main room.

Using the volume adjustment it is possible to adjust balance, bass, treble and volume individually.

BeoLink Passive enables the listening to the sound from all the products in the main room – both video and audio sources.

BeoLink Passive has the following local control options:

- Timer on/off
- PLAY / ST.BY
- Volume up/down.

Type number

Part No.	Product
1163066	JPN; BeoLink Active w IR receiver, 5 m IR-cable and 1.5 m / 5 ft mains cable
1165566	AUS; BeoLink Active w IR receiver, 5 m IR-cable and 1.5 m / 5 ft mains cable
1165666	EU; BeoLink Active w IR receiver, 5 m IR-cable and 1.5 m / 5 ft mains cable
1165766	GB; BeoLink Active w IR receiver, 5 m IR-cable and 1.5 m / 5 ft mains cable
1165866	USA/CDN; BeoLink Active w IR receiver, 5 m IR-cable and 1.5 m / 5 ft mains cable
1165966	KOR; BeoLink Active w IR receiver, 5 m IR-cable and 1.5 m / 5 ft mains cable
1166666	TH; BeoLink Active w IR receiver, 5 m IR-cable and 1.5 m / 5 ft mains cable
1166966	KOR; BeoLink Active w IR receiver, 5 m IR-cable and 1.5 m / 5 ft mains cable
1166766	CN/HK; BeoLink Active w IR receiver, 5 m IR-cable and 1.5 m / 5 ft mains cable

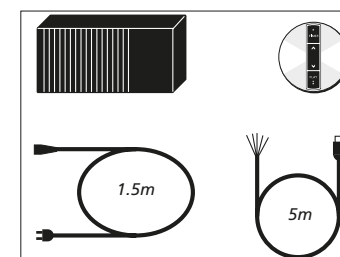

Miscellaneous

In addition to the accessories supplied, the installation also requires a Master Link cable (see [page 97](#)), plugs (see [page 126](#)), and junction boxes (see [page 133](#) and [page 134](#)).

ML/MCL Converter

Contents

ML/MCL Converter consists of a control box with built-in power amplifier and a mains cable.

Use

The ML/MCL converter has two functions:

- Takes PL signal in and via the amplifier connects to two passive speakers. See **BeoWise > Link > BeoLink > ML/MCL Converter** and in the field Technical information open the document Wiring in order to switch on and off when connected to newer audio products.
- Converts from Master Link (ML) to Master Control Link (MCL) and vice versa. A conversion is necessary where an existing MCL installation is to be used together with a Master Link driver in the main room, e.g. a BeoSound Overture.

Type number

Part No.	Product
1165066	AUS; ML/MCL Converter and 1.5 m / 5 ft mains cable
1165166	EU; ML/MCL Converter and 1.5 m / 5 ft mains cable
1165266	GB; ML/MCL Converter and 1.5 m / 5 ft mains cable
1165366	USA/CDN; ML/MCL Converter and 1.5 m / 5 ft mains cable
1169666	TH; ML/MCL Converter and 1.5 m / 5 ft mains cable
1169666	KOR; ML/MCL Converter and 1.5 m / 5 ft mains cable

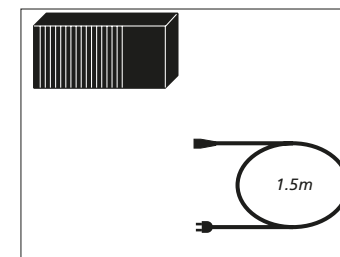

Miscellaneous

In addition to the accessories supplied, the installation also requires a Master Link cable (see [page 97](#)), plugs (see [page 126](#)), and junction boxes (see [page 133](#) and [page 134](#)).

BeoLink Converter (ML/AAL)

Contents

BeoLink Converter consists of a control box and a mains cable.

Use

BeoLink Converter is used to connect an audio and a video system where one system is based on Master Link and the other on Datalink (Audio Aux Link).

BeoLink Converter can be used both with an audiomaster and a videomaster. BeoLink Converter has autoconfiguration, which means that it can automatically decide if it is in a Master Link video system or in a Master Link audio system. Configuration takes place after mains connection.

BeoLink Converter can also be used as an ML driver*), which means that it is possible to connect e.g. a BeoCenter 2300 via the BeoLink Converter to the Master Link and thereby distribute the sound to all link room products.

Type number

Part No.	Product
1161166 1161366	EU; BeoLink Converter (ML/AAL) and 1.5 m / 5 ft mains cable
1161266 1161466	US/CDN; BeoLink Converter (ML/AAL) and 1.5 m / 5 ft mains cable

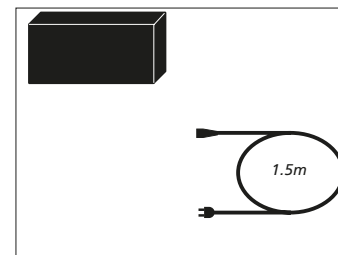

Miscellaneous

In addition to the accessories supplied, the installation also requires a Master Link cable (see [page 97](#)), plugs (see [page 126](#)), and junction boxes (see [page 133](#) and [page 134](#)).

*) BeoLink Converter, type no. 1161466 cannot be used as an ML driver.

Master Link Gateway

Contents

Master Link Gateway consists of a control box, brackets for rack mounting and a mains cable.

Use

Master Link Gateway is used to integrate Bang & Olufsen Master Link products and work as gateway to:

- Home Automation systems.
- BeoLink App (for control of all Master Link products and all Network Link products).
- Network Link products and Master Link products.

Type number

Part No.	Product
1170266 1179866	CN; Master Link Gateway and 1.5 m / 5 ft mains cable
1170166 1179966	'Other'; Master Link Gateway and 1.5 m / 5 ft mains cable

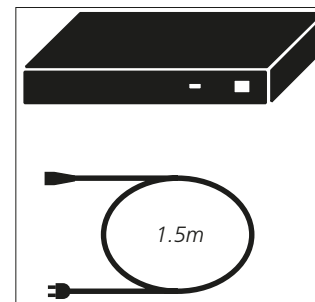

Miscellaneous

In addition to the accessories supplied the installation also may require a Master Link cable (see [page 97](#)) and/or Network Link cable (see [page 99](#)).

Master Link Delay Box

Contents

Master Link Delay Box consists of a control box, brackets for rack mounting and a mains cable.

Use

Master Link Delay Box is used to delay ML audio signals from the TV must be synchronous when played in more rooms simultaneously when more Master Link products are coexisting in the same MasterLink Network.

Type number

Part No.	Product
8052438	NL/ML Delay Box *
Optional	
8040002	EU Mains Adaptor SMPS w 1.5 m / 5 ft cable
8040004	GB Mains Adaptor SMPS w 1.5 m / 5 ft cable
8040006	AUS Mains Adaptor SMPS w 1.5 m / 5 ft cable
8040008	US Mains Adaptor SMPS w 1.5 m / 5 ft cable
8040200	CN Mains Adaptor SMPS w 1.5 m / 5 ft cable

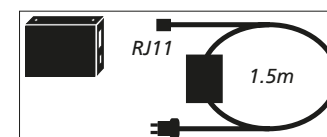

* The ML Delay Box has previously been sold as Part No. 8052427 and is now replaced by the NL/ML Delay Box with the Part No. 8052438, although the SW must be replaced with Built H8 101a and be installed using the ServiceTool. Both acting as a Master Link Delay Box.

- SW built H8 101a installed via the ServiceTool is used to delay audio from ML TV
- SW built 202a and newer, as are delivered with products Part No. 8052438 is used to delay sound between NL products and ML Audio Master products.

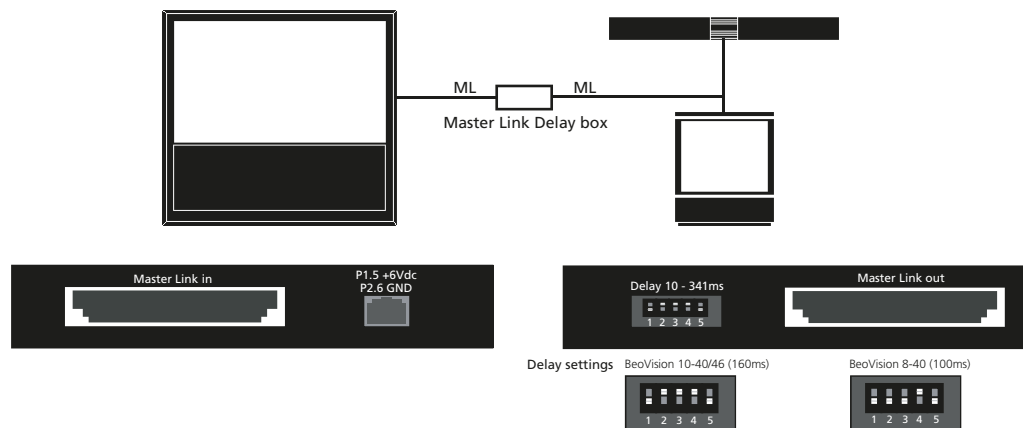

Miscellaneous

In addition to the accessories supplied, the installation also requires two Master Link cables (see [page 97](#)).

Network Link - an overall description

Network Link is the Bang & Olufsen successor to the well-known Master Link. Network Link was introduced in 2012. It is developed to give new opportunities within multi-sources, two-way control and Ethernet based on a digital platform. By the introduction of Network Link communication between the products Bang & Olufsen has started realizing the transition from analogue to digital transmission of audio and video *).

Network Link can offer sound distribution from both audio and video sources.

Audio signals are streamed in CD quality, ensuring same quality in all products. Digital content stored e.g. in the home network can be accessed without converting to analogue signals. Also DLNA is integrated in the Network Link system, providing easy control and streaming of content from mobile devices. The new Network Link concept in its pure form makes it possible to distribute sound to other rooms only using Ethernet/Wi-Fi connections. Distribution of video requires a Cat 7 cable and is distributed by the help of an HDMI switch matrix.

Network Link products are connected through a router/switch (either the ISP router or a B&O Recommended Router). The B&O Recommended Router is connected to an ISP router; see from [page 52](#) and following pages.

Service features such as online SW updates are offered automatically, and users decide when to update. This includes download and easy access of PUC tables for the control of 3rd party products; see [page 51](#).

Products based on Network Link and Master Link respectively may co-exist so it is possible to distribute sound to other rooms by installing a BeoLink Converter NL/ML between the Master Link products and the Network Link products. By installing an NL/ML Delay Box echo free party mode can be obtained ; see [page 50](#).

The BeoLink Gateway or Master Link Gateway provides the connection between Bang & Olufsen A/V products and the Home Automation controller for the home environment, and also acts as gateway when using the apps.

Network Link TVs can get audio from one other Network Link products only. The BeoLink Converter NL/ML can get audio from all other Network Link products. If an audio source can be selected in multiple rooms, then it will be played synchronized = without echo.

The Bang & Olufsen products can be controlled via any Beo remote control. Remote control can be extended by using the BeoLink App and the BeoRemote App.

*) Video signals are distributed by the use of a switch matrix; see [page 35](#), and separate Installation Guide for this.

Network Link Scenarios

NL scenario 1
- Network Link products only

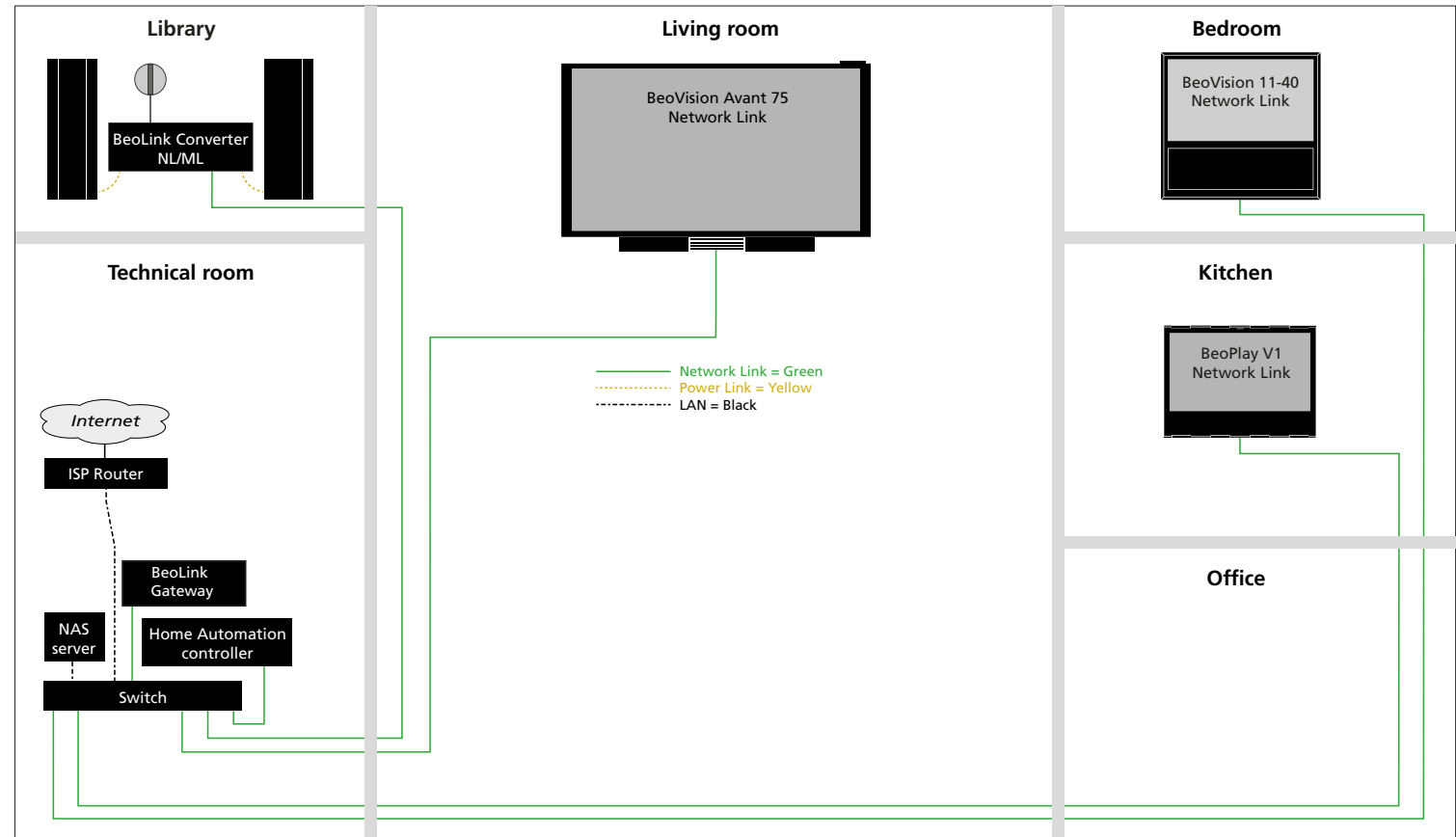

Setup with Network Link products only. In this setup the BeoLink Converter NL/ML is used for active speakers (Power Link enabled). The AUX socket can be used as line-in connection and has auto detect. Can be connected e.g. to a Play Maker. Can also include a BeoLink Gateway or a Master Link Gateway for home automation and BeoLink App control.

	BeoVision Avant 75 Living Room	BeoVision 11-40 Bedroom	BeoPlay V1 Kitchen	BeoLink Converter NL/ML Library
Link to other products	Prod 1: <BeoVision 11 Serial No.> Prod 2: <BeoPlay V1 Serial No.>	Prod 1: <BeoVision Avant 75 Serial No.> Prod 2: <BeoLink Converter NL/ML Serial No.>	Prod 1: <BeoVision Avant 75 Serial No.> Prod 2: <BeoLink Converter NL/ML Serial No.>	Primary: <BeoVision Avant 75 Serial No.> Secondary: <BeoVision 11 Serial No.>
A and V in same room	No	No	No	-
Share speakers	No	No	No	No
Option	(2)	(2)	(2)	2
ML role		-	-	Disabled *

* The BeoLink Converter NL/ML shall have the check mark removed for 'ML enabled'.

NL scenario 2
 - Network Link TV and Master Link audio

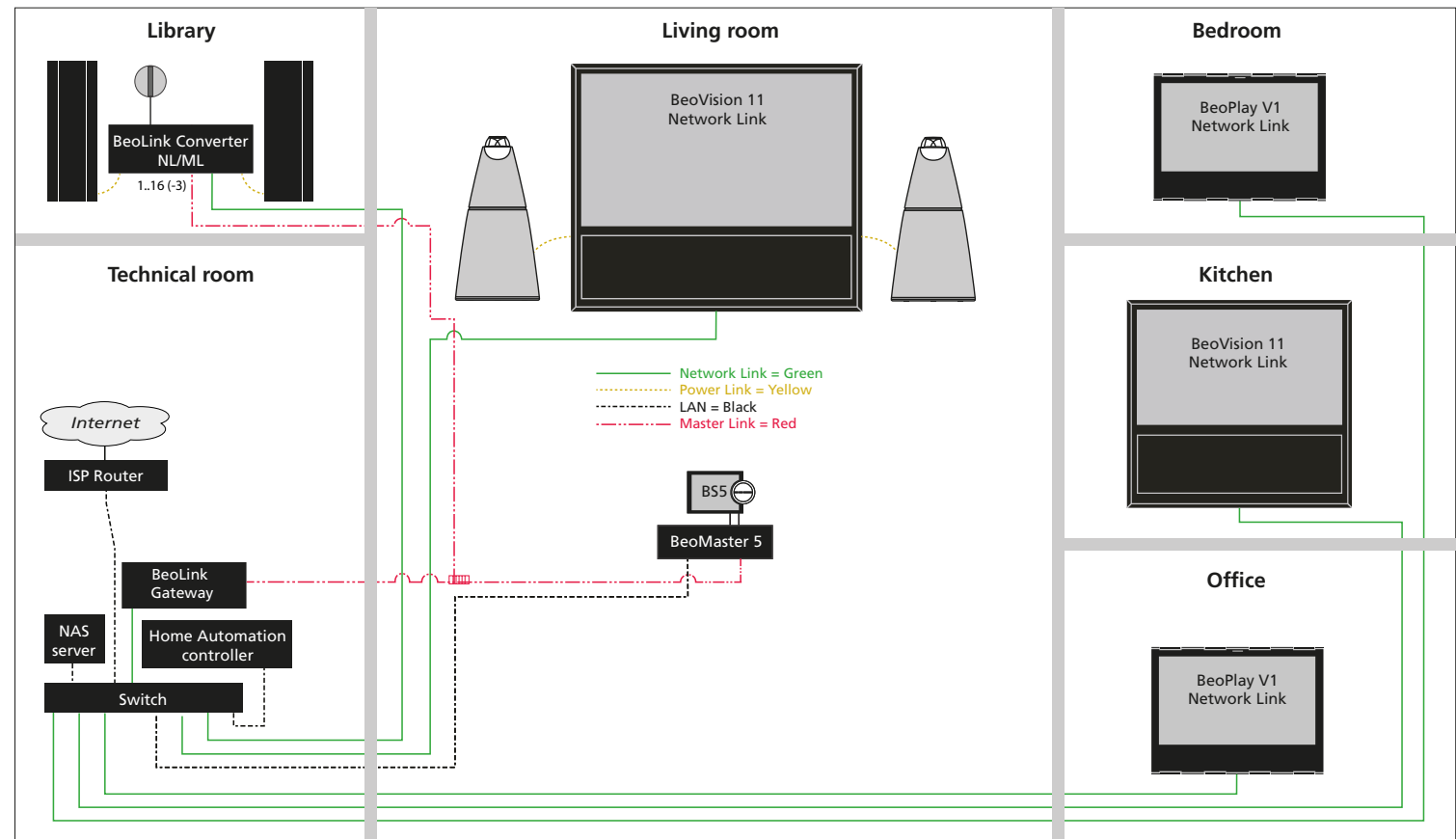

In this setup the BeoLink Converter NL/ML is used for active speakers (Power Link enabled) and at the same time it will act as a converter between Master Link and Network Link.

	BeoVision 11 Living room	BeoSound 5 Living room	BeoLink Converter NL/ML Library	BeoPlay V1 Bedroom	BeoVision 11 Kitchen	BeoPlay V1 Office
Link to other products	Prod 1: <BeoVision 11 Kitchen Serial No.> Prod 2: <BeoLink Converter Library NL/ML Serial No.>	-	Primary: <BeoVision 11 Living Room Serial No.> Secondary: <BeoVision 11 Kitchen Serial No.>	Prod 1: <BeoVision 11 Living Room Serial No.> Prod 2: <Beo Play V1 Office Serial No.>	Prod 1: <Beo Play V1 Office Serial No.> Prod 2: <BeoLink Converter Library NL/ML Serial No.>	Prod : <BeoVision 11 Kitchen Serial No.> Prod 2: <BeoVision 11 Living Room Serial No.>
A and V in same room	Yes	-	-	No	No	No
Share speakers	Yes	-	-	No	No	No
Option	(2)	0	2	(2)	(2)	(2)
ML role	-	-	V Master	-	-	-

NL scenario 3
- Echo free distribution of audio

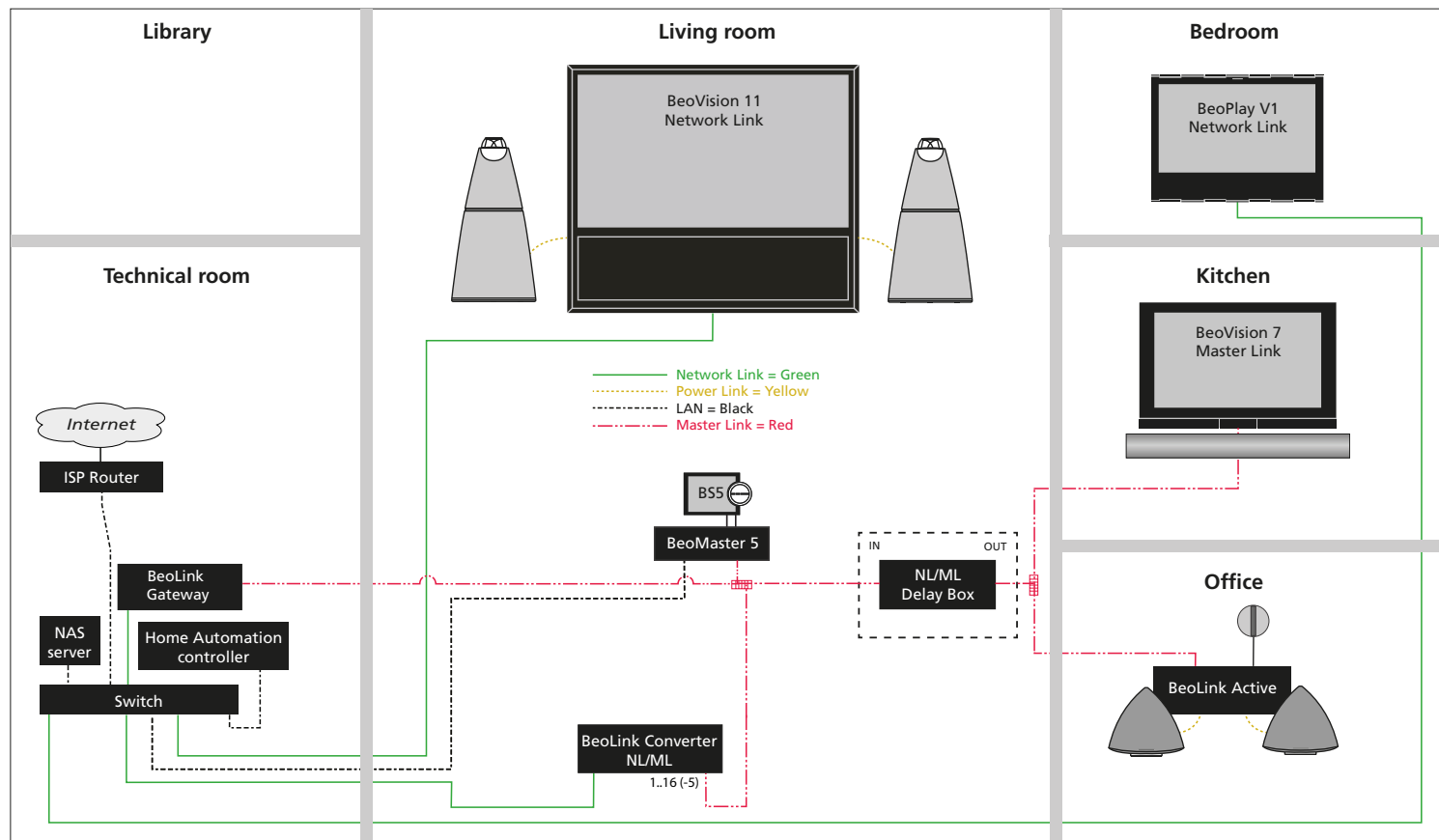

In this setup sound distribution is synchronized between all link rooms.

	BeoVision 11 Living room	BeoSound 5 Living room	BeoLink Converter NL/ML Living room	BeoPlay V1 Bed room	BeoVision 7 Kitchen	BeoLink Active Office
Link to other products	Prod 1: <BeoLink Converter Living Room NL/ML Serial No.> Prod 2: <BeoPlay V1 Bedroom Serial No.>	-	Primary: <BeoVision 11 Living Room Serial No.> Secondary: <BeoPlay V1 Bedroom Serial No.>	Prod 1: <BeoVision 11 Living Room Serial No.> Prod 2: <BeoLink Converter NL/ML Serial No.>	-	-
A and V in same room	Yes	-	-	No	-	-
Share speakers	Yes	-	-	No	-	-
Option	(2)	0	-	(2)	6	6
ML role	-	-	V Master	-	-	-

NL scenario 5
 - Master Link TV in main room
 and mix of NL and ML products

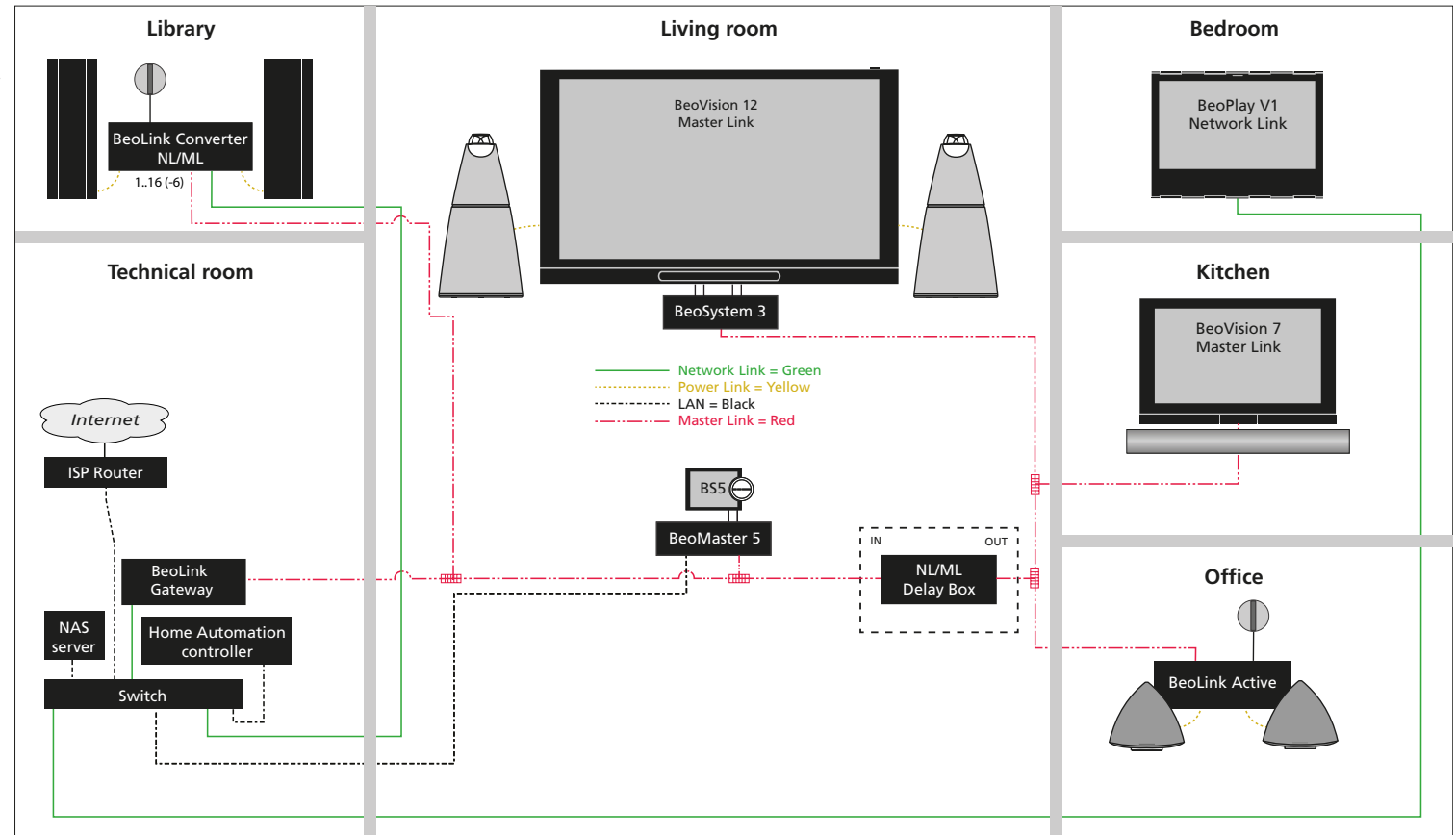

With Master Link product in the main room the sound is synchronized from audio sources in all link rooms. The BeoLink Converter NL/ML is set up as an audio slave in its menu. In the Bedroom there is free access to sound distribution from either audio or video sources.

	BeoVision 12 BeoSystem 3 Living room	BeoSound 5 Living room	BeoLink Converter NL/ML Library	BeoPlay V1 Bed room	BeoVision 7 Kitchen	BeoLink Active Office
Link to other products	-	-	Primary: <BeoPlay V1 Bedroom Serial number>	Prod 1: <BeoLink Converter NL/ML Library Serial No.>	-	-
A and V in same room	-	-	-	No	-	-
Share speakers	N/A	-	-	No	-	-
Option	2	0	2	(2)	6	6
ML role	-	-	A Slave	-	-	-

Network Link - link products

BeoLink Converter NL/ML

Contents

BeoLink Converter NL/ML consists of a control box.

BeoLink Converter NL/ML is supplied with a mains cable.

Use

BeoLink Converter NL/ML has two main purposes:

- The BeoLink Converter NL/ML is the interface between the Network Link and the Master Link system and makes it possible to add a Network Link product to a current Master Link setup.
The Product ensures both conversion between convert control signals and audio signals.
- The BeoLink Converter NL/ML can also be used to make an audio link rum. The product has Power Link sockets for speaker connections and RCA connectors for Line-in.

An IR-eye must be connected for remote control. The product can work as a link rum at the same as it works as a converter

The BeoLink Converter NL/ML has a build-in Web Interface, which is used for set-up. The product is default set up as a 'Video Master' in option 2 and can be set to Audio slave and Audio Master.

Part number

Part No.	Product
1179011	BeoLink Converter NL/ML w 1.5 m / 5 ft mains cable
Optional	
1200225	Wall Bracket incl. fittings
8089119	IR-eye incl. 10 m / 33 ft cable; can be extended up to 100 m / 328 ft; see page 119

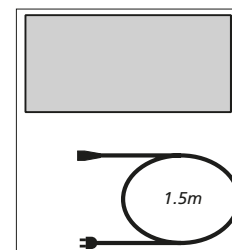

Miscellaneous

In addition to the accessories supplied, the installation also requires Network Link cables (see [page 99](#)) Master Link cable (see [page 97](#)) and plugs (see [page 126](#)), and junction boxes (see [page 133](#) and [page 134](#)).

NL/ML Delay Box

Contents

NL/ML Delay Box consists of a control box.
 Note: An appropriate Mains Adaptor must be ordered separately.

NL/ML Delay Box, appropriate for the installation, is chosen as an option.

Use

The NL/ML Delay Box is a sound delay box between the Network Link via the BeoLink Converter NL/ML and the Master Link system. The NL/ML Delay Box makes it possible to add a Network Link product to a current Master Link setup for echo free audio listening in a mixed master Link and Network Link setup.

The NL/ML Delay Box is designed to delay audio signals from the main room audio system to the Master Link products in the other rooms. NL/ML Delay Box ensures that audio signals are played synchronously.

Part number

Part No.	Product
8052438	NL/ML Delay Box
Optional	
8040002	EU Mains Adaptor SMPS w 1.5 m / 5 ft cable
8040004	GB Mains Adaptor SMPS w 1.5 m / 5 ft cable
8040006	AUS Mains Adaptor SMPS w 1.5 m / 5 ft cable
8040008	US Mains Adaptor SMPS w 1.5 m / 5 ft cable
8040200	CN Mains Adaptor SMPS w 1.5 m / 5 ft cable

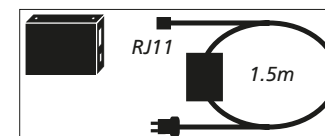

Miscellaneous

In addition to the accessories supplied, the installation also requires two Master Link cables (see [page 97](#)).

BeoLink Gateway

Contents

BeoLink Gateway consists of a control box.

BeoLink Gateway is supplied with a mains cable.

Use

BeoLink Gateway is used to integrate Bang & Olufsen BeoLink products (both Master Link and Network Link) with Home Automation systems.

The BeoLink Gateway also works as the integration point for the BeoLink App, which gives the opportunity to control the entire home (all connected A/V and Home Automation devices) via iOS tablet or smartphone.

Part number

Part No.	Product
1170311	BeoLink Gateway w 1.5 m / 5 ft mains cable
Optional	
1200225	Wall Bracket incl. fittings

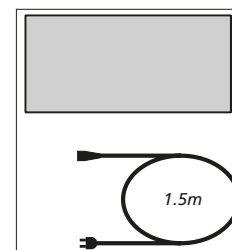

Miscellaneous

In addition to the accessories supplied the installation also may require a Master Link cable (see [page 97](#)) and/or Network Link cable (see [page 99](#)).

ML Power Box

Contents

ML Power Box consists of a control box.

Use

The ML Power Box is a box supplying Master Link products with power, in setups where no main Master Link master product (Audio or Video) is part of the Master Link setup.

The ML Power Box is power supplied via the USB cable (USB A to USB mini B) connected to the BeoLink Converter NL/ML.

One RJ45 connector is connecting to the BeoLink Converter NL/ML and the other RJ45 connector is used to connect to the Master Link products.

Part number

Part No.	Product
8052447	ML Power Box
Optional	
6270848	Cable USB A - USB mini B, 2 m / 6.6 ft black

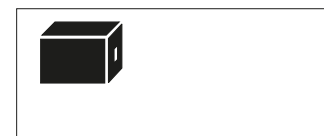

Miscellaneous

Cat 7, Network Link Product Cables are used as the shield connects to the GND.

Power Link - an overall description

Power Link is a Bang & Olufsen way to connect active loudspeaker systems to audio and video products. It ensures high quality in handling the audio signals and proper control of link products and the correct sequence when powering On and Off of active loudspeakers.

The connections are established using Power Link cables. These can have DIN and/or RJ45 connectors in various combinations to match the products involved; see [page 101](#).

Over time there has been a wish to have as thin cables as possible both to obtain ease of installation and to ease the hiding of the cables. Also the number of functions that could be operated via the Power Link cable has changed over time. This has influenced the number of wires in the Power Link cable that has changed to meet the requirements - and consequently Power Link cables exists in various diameter - from Ø 2.5 mm (max. length recommended is 10 m / 33 ft) to Ø 5.5 mm. See [page 79](#) about length of cables and [page 101](#) about Power Link cables.

Bang & Olufsen products provides from 2 channel stereo and up to multi- channel surround sound. The Power Link connectors typically convey a left and a right speaker signal or alternatively centre and subwoofer.

Power Link - products

Components for Power Link are cables and related installation accessories, to be found in the Passive Infrastructure section; see [page 76ff](#).

Setup

Tips for installation are also found in the sections Cable management/handling [page 76](#) and Installation principles [page 81](#).

Wireless Power Link

Get rid of the cable clutter and make installations less complex and reduce installation cost. Consequently flexibility is enhanced. The solution is Wireless Power Link.

Think of active speakers only connected by a mains cord. Think of set-ups spanning from 2 channel stereo set-up to a multi- channel surround set-up (up to 8 channel in a 7.1 arrangement). All sound is distributed wirelessly based on the unprecedented WiSA standard using the unlicensed 5 GHz band. See more details in the Installation Guide for BeoLab Transmitter 1 on **BeoWise > Speakers > Transmitter > Transmitter 1**.

Think of free placement of speakers, and easy replacement later on, just moving the mains cord. No wiring between the master and the speakers to consider. Within the defined boundaries that are an area of 9 × 9 m (30 × 30 ft) and a max distance between transmitter and speaker of 12 m / 40 ft. Also a max of three 5 GHz transmission systems within an area called the 6 m / 20 ft zone is recommended. These requirements leaves sufficient margin to compensate for varieties in equipment like antenna variations, RF calibration tolerances and temperature variations and varieties in the surroundings like signal reflection objects in the room and persons moving around. Speakers reports the received quality to the transmitter and if below a certain limit, a new and cleaner channel is selected.

Wireless multichannel transmitters are part of the some Bang & Olufsen TV or Bang & Olufsen Audio products providing the possibility to connect to any Bang & Olufsen speaker with built in wireless receiver. Alternatively BeoLab Transmitter 1 can be connected to Bang & Olufsen TVs without a Wireless or even 3rd party TV/AV products. In the receiver end Bang & Olufsen has a port folio of speakers designed as wireless speakers. Furthermore a BeoLab Receiver 1 can be connected to any active Bang & Olufsen speakers.

Examples of products as of may 2015:

Products using Power Link Transmitter:
- BeoVision 11
- BeoLab Transmitter 1
- BeoVision Avant
- BeoSound Moment

Products using Power Link Receiver
- BeoLab 17
- BeoLab 18
- BeoLab 19
- BeoLab 20
- BeoLab Receiver 1
- Beolab 90

Wireless Power Link - link products

BeoLab Transmitter 1

Contents

BeoLab Transmitter 1 consists of a control box white cable tray and a mains cable.

Use

BeoLab Transmitter 1 is used to connect to former Bang & Olufsen TV without a built-in transmitter and 3rd party products (audio and video) audio outputs and distribute to wireless Bang & Olufsen WiSA approved speakers. Inputs can be: up to 8 channel Power Link, analogue 2 channel audio line-in using RCA connectors or Power Link connector (RJ45), digital audio via TOSLINK. 2 channel audio line-in using the Power Link connectors can also be set up to up to 11 speakers. See more details in the Installation Guide for BeoLab Transmitter 1 on **BeoWise > Speakers > Transmitter > Transmitter 1**.

Adding an optional IR-receiver makes volume control of sound from 3rd party products possible using a Beo remote.

Note: Set BeoLab Transmitter 1 to Always On to hear sound from the speakers almost instantly.

Part number



Part No.	Markets	Variant	HF
1150525	Argentina, Brazil, Peru, Philippines, United Arab Emirates, Uruguay, Vietnam	ALL	HF1
	Andorra, Austria, Belgium, Bulgaria, Croatia, Czech Republic, Denmark, Estonia, Faroe Islands, Finland, France, Georgia, Germany, Greece, Greenland, Hungary, Iceland, Italy, Latvia, Lebanon, Liechtenstein, Lithuania, Luxembourg, Monaco, Norway, Oman, Poland, Portugal, Romania, Saudi Arabia, Serbia, Slovak Republic, Slovenia, Spain, Sweden, Switzerland, The Netherlands, Turkey		HF2
	Bahrain, Chile, Egypt, India, Malaysia		HF3
	Azerbaijan, Israel, Kazakhstan, Morocco, Russia, Ukraine, Uzbekistan		HF4
	Côte d'Ivoire, Indonesia, Nigeria, Pakistan, Qatar		HF5
	Jordan		HF8

1150625	Canada, Dominican Republic, Mexico, USA, Virgin Islands	US	HF1
	Panama		HF3
1150725	Hong Kong, Namibia, South Africa	GB	HF1
	Botswana, Ghana, Ireland, United Kingdom		HF2
	Singapore		HF3
	Kuwait		HF4
1150825	Australia, New Zealand	AUS	HF1
1150925	Japan	J	HF6
1151025	China	CN	HF5
1151125	Korea	KOR	HF3
1151225	Thailand	TH	HF1
1151325	Taiwan	TWN	HF7
Optional			
6271259	IR-receiver for BeoLab Transmitter	-	-

Miscellaneous

In addition to the accessories supplied, the installation also requires appropriate cables for connecting the source signals: Power Link cables, RCA cables or TOSLINK cables.

BeoLab Receiver 1

Contents

BeoLab Receiver 1 consists of a control box and a power adaptor (PSU) and mains connector adaptor to match the wall outlet.

Use

BeoLab Receiver 1 is used to receive a signals from WiSA approved transmitter products from Bang & Olufsen and from 3rd party vendors. The BeoLab Receiver 1 is connect to an active Bang & Olufsen speaker.

Note: One BeoLab Receiver 1 is needed per speaker.

Part number



Part No.	Markets	Variant
1151426	Andorra, Austria, Azerbaijan, Belgium, Bahrain, Bulgaria, Côte d'Ivoire, Croatia, Czech Republic, Denmark, Egypt, Estonia, Faroe Islands, Finland, France, Georgia, Germany, Ghana, Greece, Greenland, Holland, Hungary, Iceland, Indonesia, Israel, Italy, Jordan, Kazakhstan, Latvia, Lebanon, Liechtenstein, Lithuania, Luxembourg, Malaysia, Monaco, Morocco, Namibia, Nigeria, Norway, Oman, Pakistan, Peru, Poland, Portugal, Qatar, Russia, Romania, Saudi Arabia, Serbia, Slovak Republic, Slovenia, Spain, Sweden, Switzerland, Thailand, Turkey, United Arab Emirates, Ukraine, Uruguay, Uzbekistan, Vietnam	ALL
1151526	Canada, Dominican Republic, Japan, Mexico, Panama, Taiwan, USA, Virgin Islands	US
1151626	Botswana, Chile, Hong Kong, Ireland, Kuwait, Philippines, Singapore, South Africa, United Kingdom	GB
1151726	China	CN
1151826	Argentina, Australia, Brazil, India, Korea, New Zealand	RST

Miscellaneous

In addition to the accessories supplied, the installation also requires appropriate Power Link Cables; see [page 103](#).

Audio Distribution

Distribution of high quality audio signals, in stereo has been part of the BeoLink concept for decades. This has taken place - and is still taking place via the Master Link network and today also via the Network Link.

See also about "BeoLink Multiroom" [page 38](#).

Video Distribution

Distribution of video signals between TVs has been handled by coaxial cables and RF distribution via Modulator. The video sources are connected to the main room TV using SCART cables or HDMI cables. The sources can then be used in link room TVs. Using RF distribution sets the picture and sound quality limits to Standard-definition picture and mono sound.

A more advanced distribution of video involves an HDMI switch matrix (see the following pages) and distribution involving HDMI cables - on distances up to 6 m / 20 ft - and even Cat cables and extenders - up to 100 m / 328 ft - depending on distances between products.

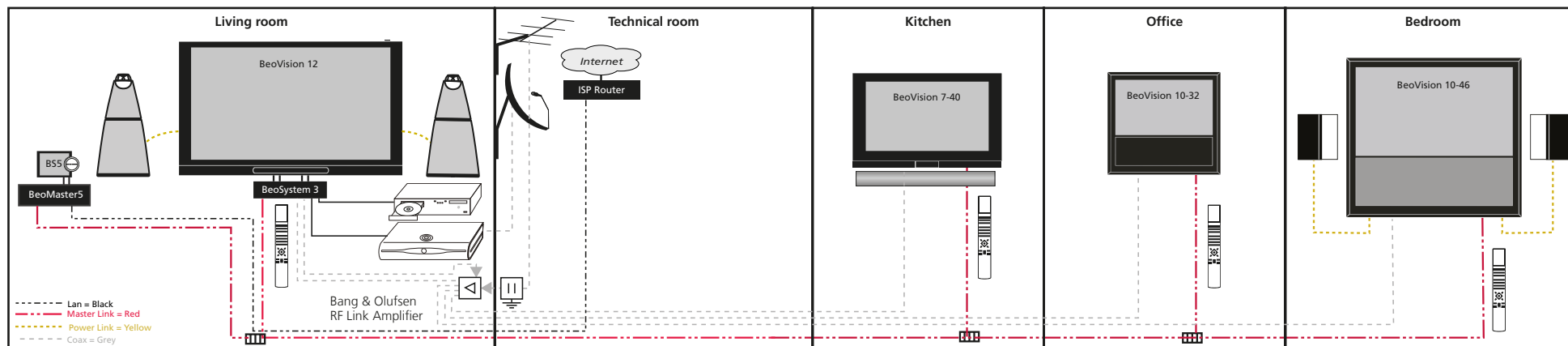

Example of video distribution by the help of coaxial cable in a setup comprising Master Link products.

In an HDMI matrix set-up it is possible to handle full HD signals as well as demands such as 7.1 surround sound and 3D.

Example of video distribution by the help of an HDMI switch matrix using Cat 7 cable in a setup comprising a mix of Network Link products and Master Link products.

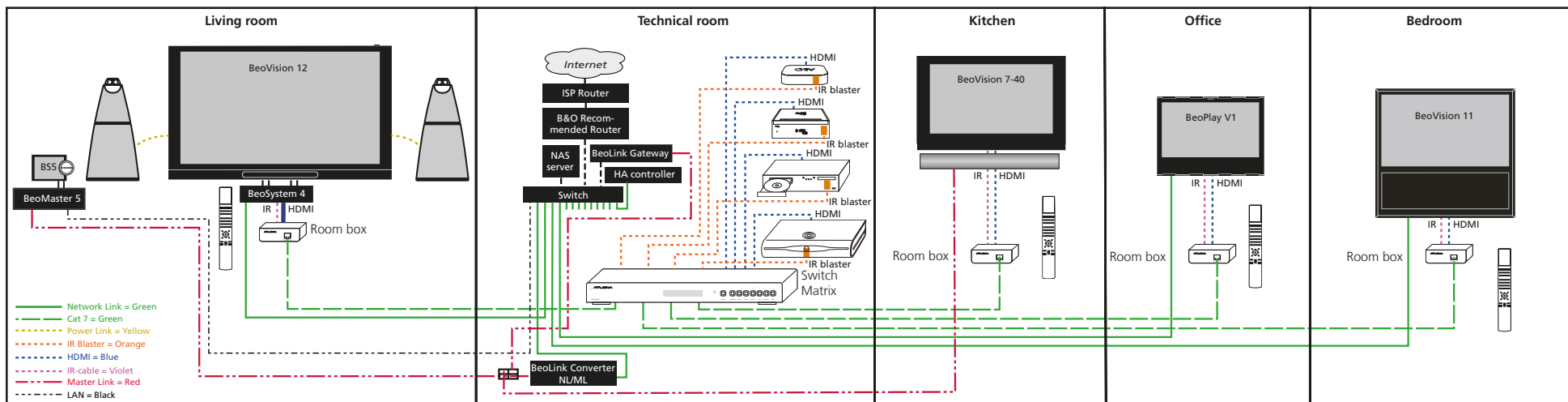

In a Network Link setup video sources are either connected directly to each TV using HDMI cable or distributed from a switch matrix via Cat cable to the TVs in the individual rooms. The switch matrix and the various source products may be placed in e.g. a technical room or centrally placed cabinet. Source products like Blu-ray Disk players or gaming consoles may be placed locally in the room desired and connected to the switch matrix using an extender solution (not shown here; see individual installation guides for such solutions).

Example of video distribution by the help of an HDMI switch matrix using Cat 7 cable (digital video) in a setup comprising a mix of Network Link products and Master Link products (only the Audio product).

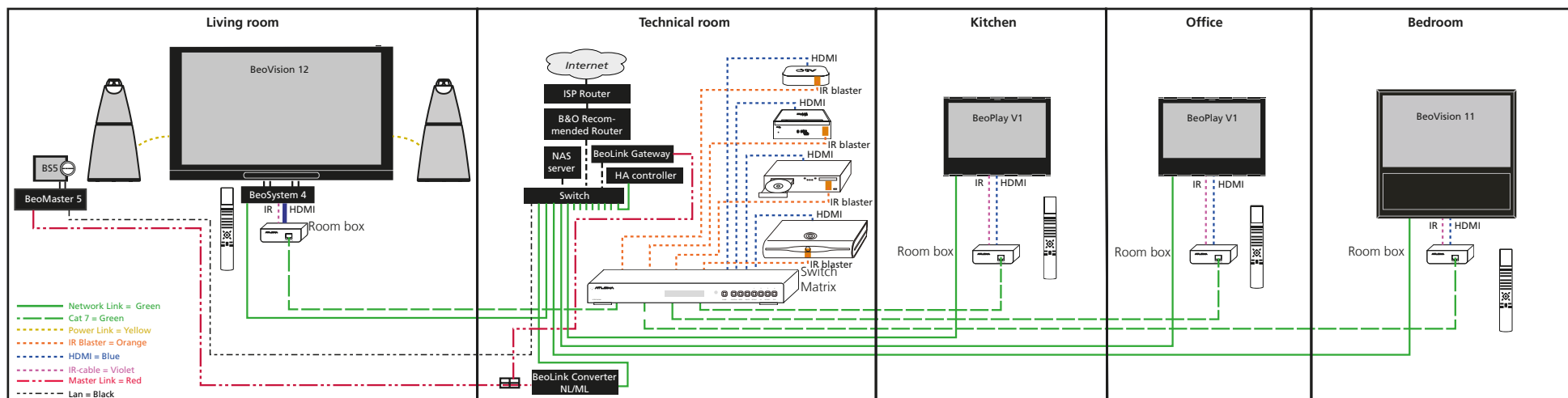

Video distribution - distribution products

Regarding various HDMI distributing products, see **BeoWise > 3rd party products > HDMI Distribution**.

Bang & Olufsen recommends Atlona products for HDMI distribution products.

More information and examples on product set-up can be found on <http://atlona.com/bang-and-olufsen/>

BeoLink Multiroom

The BeoLink experience now covers the BeoLink Multiroom solution. Bang & Olufsen takes a further step by not only involving audio products but compared to other multiroom solutions Bang & Olufsen also involve the TV products to be integrated for the multiroom sound solution.

By this you can take your sound experience with you wherever you are - to and from your audio products, the sound from the TV products and the sources connected to it.

Consequently you can take the sound experience with you wherever you are and whatever product you use.

The BeoLink Multiroom solution is fully supported by all Network Link products and compatible with former Master Link products.

More than just Multiroom

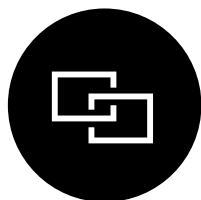

BEOLINK MULTIROOM

The BeoLink Multiroom solution entails the following elements:

- Sound distributed across more rooms and products:
 - The distribution is echoless, meaning the sound is synchronized even listening to two products in the same room or the sound is distributed to multiple rooms.
 - Join, expand and borrow sources are the functions used to listen to various sound in all products, same sound in more products or same sound in all products.

- One remote operation
 - All Bang & Olufsen product can be operated by only one - i.e. the same - remote control. This is regardless of being a TV product, an audio product, and whichever old or new product is to be operated.
 - Bang & Olufsen is also known for solutions, that makes it possible to operate almost all connected sources with the same 'one remote'.
 - Streaming services are also embraced in this concept as a source to distribute.
 - BeoMusic App and BeoRemote One are optimised for multiroom handling. The operation principles are the same whatever solution is used. Tablets and smart phones are part of the offering.

- One-touch operation
 - One-touch operation is another Bang & Olufsen experience. This means play and join by operating directly on the product to select the exact source.
 - By yet another single touch, the sound can be joined from another source.
 - All stand-by operation can be applied via the BeoMusic App, the remote controls or even some products - by which the entire system is brought to stand-by applying a long touch.

- Future-proof
 - Grow as you please is also a concept that is supported by the Bang & Olufsen solutions. This means adding more products in more rooms over time is still based on the BeoLink concept. Even more locations may be involved.
 - Bang & Olufsen offers unparalleled longevity of products both by providing up-to-date software updates and by ensuring that new and old products can be part of the total solution.

BeoMusic App for BeoLink Multiroom

The BeoMusic App is the controller of the BeoLink Multiroom concept.
The mobile device can be oriented in the two directions: portrait view and landscape view.

The major difference between the BeoMusic App shown on the mobile phone and the tablet is, that more products are seen on the tablet, due to size of display, and also that the volume control is always shown on the tablet.

Products are shown in alphabetical order according to the network alias .

A product is indicated by light blue background colour when selected and thereby active. A dark blue colour background with greyed out text indicate a product with no selectable sources, and a dark blue colour with white text indicates a product with selectable sources.

When more products are present than can be shown in one screen, scroll vertically or horizontally according to view.

See also step 11 in "Good installation practice" [page 42](#).

App in portrait mode

In portrait mode, the BeoMusic App shows the product menu.

In the top of the App is shown the status of which track or channel is playing in the selected product/room and a progress bar for this. In the bottom of the App it is possibilities to control the volume of the selected product and selecting next or previous track/channel.

In the background a graphics is seen that either relates to the track or the radio station.

Each product is represented by a line, having an icon of the product to the left and displays the data about the product. The top line shows the product/room name and the next line shows the source.

In each product line it is possible to handle the individual product.

Pressing **▶** will display the sources for the product and pressing **▶** on a source will display the content of the source.

Pressing **◀** (when present) will go back one step.

Pressing the product icon in the topmost status line will return to the product list.

Note: the All Standby button is placed in the bottom of the product list, and can only be reached by scrolling up the product list. Thus the All Standby function is underneath the volume part of the menu if not revealed by scrolling up.

The volume wheel is not seen for a TV in standby and also not for a BeoLink Converter NL/ML as no feedback is returned to the App.

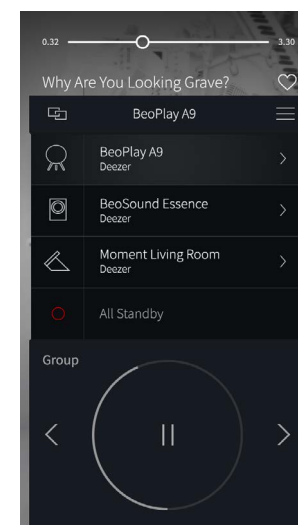
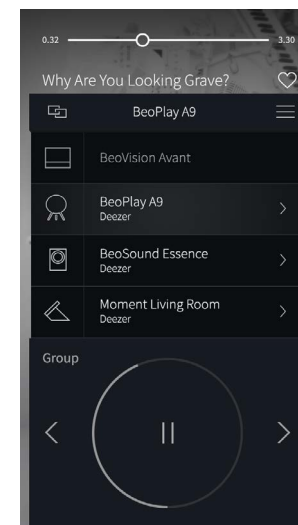

App in landscape mode

Each product allocates a field.

The top line informs about the track/station/source currently playing. If the product is not playing the line is left blank. The second line shows the product/room name and below this a product icon of the product is displayed.

A selected product is changing colour to light blue, and operating possibilities are marked by the **+** and **x**; see further details in the following.

Expand

Expanding sound (pushing / lending) that is playing on one product to be played on one or more of the other products, that may be in the same or another room.

Expanding sources between products, is controlled by the BeoMusic App only.

- +** Pressing the **+** button on a product/room result in expanding the source played on the selected product/room to be played in that room. The **+** change to a **x** as well as the product/room also becomes light blue - indicating that the source is played in all rooms that are light blue simultaneously.

The product/room being the leader is indicated by a circular glow.

Note: Products that are in an integrated setup does not show a **x** as the sources from this are played and controlled in the TV.

- Expand needs up to three operations to: start, select source and expand this - always operated by the BeoMusic App.

- x** Pressing the **x** button on a product/room unlink from the product played or terminate an ongoing session, if played in one room only. Pressing the **x** button on the product/room having the source, will let the product go to Standby although the source will still be playing in the other room.

See video introduction to the BeoMusic App on YouTube: search for BeoMusic App Multiroom.

Join

Joining sound is selecting sources that are already playing on another product and to be played on the product that is being operated.

Such operation is done either via a remote control or operation actions made on the interface and touch functions of the product itself. Join also counts for streaming services hosted on the product.

Borrow

Borrowing a sound source is selecting a specific source from another Network Link product, even though the controlled product is playing another source or in Standby.

The borrow source function is currently available using the BeoLink Converter NL/ML and Network Link TVs only.

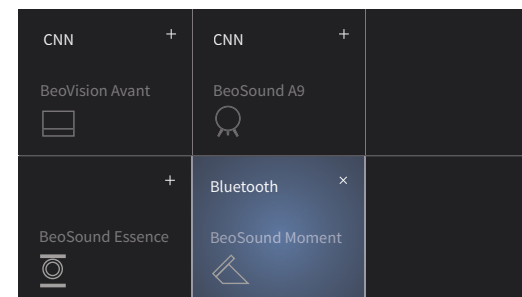

Product understanding

Precautions

Ensure to give products proper and easy to understand network names, e.g. <Room name> and <Product> if more of the same product is in the same network. Example: "Kitchen BeoPlay A9". Note that all products are already represented by an icon.
Ensure thorough setup. Network name is set in: TV menu, BeoSound Moment menu, via BeoSetup App.

Echo / Lip-synch / Sound drop-outs

Distributing sound on Network Link imply process time for conversion from analogue signal to digital data in the source (fixed time), time for transmission (time depends on network capabilities) and time for conversion in the receiver product (fixed time).

To avoid echo, a playback delay is set to some smaller value (typically between 50 to 1000 ms) to make sure that all players are constantly synchronized. The delay value is broadcasted to all Network Link products. Thereby all products will expose the audio stream at the same time. If all products are cabled the Network Delay LAN value is set to 50 ms.

As soon as one product is connected wirelessly, the Network Delay WLAN value is per default set to 1000 ms. This is to compensate for sound drop-outs in weak networks. In some situations this value must be increased to avoid sound drop-out, but can also in other networks easily be decreased. A value as low as possible is recommended.

Note: The Network Delay is also experienced as a response delay when channel change takes place.

Note: Never adjust the Network Delay WLAN to less than 200 ms.

If sound from video sources are never distributed, the Network Delay WLAN value can be set to as high a value as needed to avoid sound drop-outs.

If sound from a video source (the TV or any connected video source) is distributed to other Network Link products the audio stream and the video stream can be delayed up to 200 ms only to avoid lip-synch. When the Network Delay WLAN is set to 200 ms there will be no echo. When Network Delay WLAN is set to any higher value the audio stream to other products is delayed according to the Network Link WLAN setting (when one or more Network Link product is connected wirelessly) and consequently echo is experienced between the TV and other products exposing the sound stream.

This is why it is recommended to set the Network Delay WLAN to 200 ms if sound from video sources are distributed.

Note: If a product connected wirelessly is removed from the setup but is still in the product configuration of the Network Link products, this product is still considered a wirelessly connected product.

Remember to delete the removed product from the Network Link product configuration via one of the other remaining products. This will be broadcasted.

The wireless network can e.g. suffer due to: the capability of the router processor and bandwidth, impact by other wireless routers, impact by electrical noise from other wireless equipment e.g. alarms, microwave ovens etc., and heavy traffic to mention the most important reasons.

Note: If it is not possible to obtain a stable wireless transmission, move to another channel in the 2.4 GHz band or the product must be cabled or Powerline may be an alternative; see [page 66](#).

BeoLink Converter NL/ML - product choices

When setting up the BeoLink Converter NL/ML, the ML products to include must be selected from the **App settings**. This is to ensure correct presentation of name and product icons in the BeoMusic App. The name is entered in **Friendly name in Apps** field, and the icon shown is the result of choosing the product from the drop-down-list **Product controlled by Apps**.

BeoSound 5 / BeoMaster 5

Spotify can be distributed from BeoMaster 5, although always controlled from BeoSound 5.

BeoSound Moment

BeoSound Moment SoundHeart must preferably be cabled to the LAN network for the best result. Note : BeoSound Moment Jukebox is connected to the network wirelessly and is using the 2.4 GHz band. There is no streaming from the JukeBox.

Good installation practice

- 1 Make sure that all products are connected to the same subnet including the mobile devices.
- 2 Always connect products using cables if possible.
- 3 If wireless connections are used, please ensure to use the 5 GHz band if possible.
(Hint: e.g. control 2.4 GHz and 5 GHz by individual SSID; use BeoSetup App).
- 4 Only if not possible to use the 5 GHz use the 2.4 GHz band connections. Ensure to use channels with as less traffic as possible.
Note. Use either of the channels 1, 6, 11; see [page 58](#).
Tip: The app named WiFi Analyzer from farproc is a freeware app for Android devices to show traffic intensity in wireless channels.
- 5 If wireless connections are used, it is recommended to use a Bang & Olufsen recommended dual-band router and preferably a router supporting IEEE 802.11n or IEEE 802.11ac; see list on **BeoWise > 3rd party products > Active Network Components**.
In case the network provider router is not sufficiently robust, the “Bang & Olufsen Network setup” [page 53](#), may be used to.
- 6 Increase the Tuneln buffer (also used when streaming from Deezer) in case of drop-outs from this streaming. Use the BeoSetup App to make such changes.
- 7 Ensure that no other devices on the network is streaming over 20 Mbps in total; e.g. if certain network activities like gaming is widely taking place the “Bang & Olufsen Network setup” [page 53](#), may be used to separate multiroom activities from such bandwidth demanding activities.
- 8 The RSSI of the client should be -65 dBm or better.
- 9 The SNR (signal-to-noise-ratio) should be 20 dB or better; see [page 57](#) and [page 69](#).
- 10 If possible, enable QoS (Quality of Services) in the home router/switch. Note, that this is based on MAC addresses of the products dealt with in the network.
- 11 The BeoMusic App caches products per network in landscape mode only. This provides the possibility to expand to products in Standby. Removed products may also be shown due to the cached information. The caching can be wiped out in the settings menu with the mobile device. This might be relevant in stores and other huge installations.

Limitations

AirPlay

Not distributable. Not all products supports AirPlay.

Audio products

Be aware that Audio products can be either a Network Link Product or a Master Link product.
Some products supports receiving streaming from a Bluetooth device.
BeoSound Essence MK II can currently not be operated by a Bang & Olufsen remote control (BeoRemote One and Beo4).

Beo4

The Beo4 is not supporting multiroom although it can control any product in the setup. Also join is supported related to NL audio products only.
ML audio products does not support join.

BeoMusic App

Sources on the Network Link TV can not be started by the BeoMusic App.

BeoRemote App

The BeoRemote App is not supporting multiroom although join and borrowed sources are supported.

BeoLink App

The BeoLink App, operated through the BeoLink Gateway, is currently not supported in products running a display-less audio product (e.g. BeoSound Essence, BeoPlay A9) (i.e. in a home automation setup these products and their sources cannot be operated by the BeoLink App).
Instead use the BeoMusic App.

BeoSound Moment

Spotify Connect is so far not supported.

Connections

BeoLink Multiroom connections:

- Up to 32 products connected in the system (not steaming). (The number depends on the IT setup, and can be more or less).
- Up to 18 products playing simultaneously in a wired setup from the same source.
- Up to 8 products playing simultaneously in an wireless setup.
- Up to 6 products playing simultaneously in a wired setup from the same source while decoding Hi-Res audio (FLAC 192 kHz/24-bit (wired setup)).

Join / One-touch-join

In the display-less audio products (e.g. BeoSound Essence MK II, BeoPlay A9 MK II, Beoplay A6), it is possibility to disable one-touch-join.
Settings are changed using the BeoSetup App.
When one-touch-join is disabled, it is only possible to join sources from the product itself and prohibits selection of sources from other products in the network. This feature is e.g. feasible with a product in a room, where it is not desirable to listen to sources from other product.
Note: Disabling one-touch-join does not prevent sources from other rooms to be expanded to this product.

Other limitations

- Gaming mode and 4K content will cause echo.
- Distribution of sound from a Video Source from an Master Link TV to Network Link products will cause echo.

Power Link speakers

Speakers without built in Wireless Power Link receiver can be connected using Power Link cables or alternatively be connected wirelessly by adding a Wireless Power Link Receiver next to the speaker.

Spotify Connect

Only distributable to products supporting Spotify Connect. TVs cannot distribute Spotify Connect.

Video products

Note: Streaming of sound from a video source is disabled in the factory default setting to avoid Echo problems.

To enable distribution of sound from a video source, do as follows:

Press **MENU > SETUP > PRODUCT INTEGRATION > SOUND FROM VIDEO SOURCES** and select **ON**.

When any product in the network is connected wirelessly, the Network Link delay is set to 1000 ms (default). This will cause echo problems when distributing sound from a video source (TV, UHD/DVD player etc.).

The following are feasible actions to take to minimize echo problems and sound drop-out problems:

- 1 Use LAN cables to wire all Network Link products to the home router. By this the delay value is set to 50 ms.
- 2 Place products in far apart locations; i.e. in separate rooms. Echo will only be heard if it is possible to listen to two products at the same time.
- 3 When a product is connected wirelessly, the delay value can be changed to 200 ms to avoid echo and lip-synch problems when distributing sound from video sources.

The Network Link delay can be changed in the TV as follows:

Press **MENU > SETUP > Red-button + Centre-button** within 3 sec. > **SETTINGS > NETWORK DELAY, WLAN** and change the settings to **200 ms**. (Adjust to the lowest possible value as long as sound drop-outs are avoided; see [page 41](#)).

- 4 If solutions 1, 2 or 3 are not feasible to use, then disable distribution of sound from a video source.

Press **MENU > SETUP > PRODUCT INTEGRATION > SOUND FROM VIDEO SOURCES** and select **OFF**.

Wireless Power Link speakers

Speakers with built in Wireless Power Link receiver can be connected using this wireless technology or alternatively be connected using Power Link cables.

Master Link - Delay / Echo

When the setup comprises a mixture of Network Link products and Master Link products it might in certain situations be necessary to add the NL/ML Delay Box; see "NL/ML Delay Box" [page 27](#).

Power for ML

Note: If there is no master products (Audio or Video product) of the Master Link type, an ML Power Box (Part No.: 8052447; see [page 29](#)) must be placed between the BeoLink Converter NL/ML on the Master Link cable.

Home Automation

The BeoLink Gateway or the Master Link Gateway for home automation and BeoLink App control can easily be part of the setup. Currently some limitations are present, see [page 43](#).

Time based events can be configured using the BeoLink App as it can control all resources, e.g. a morning event that includes: lighting, drapes and curtains, AV products etc.

BeoLink Multiroom Scenarios

A BeoLink Multiroom - Scenario Handbook is available with a comprehensive scenario collection. The example on the following page is just an example from here.

The BeoLink Multiroom - Scenario Handbook gives general - nice to know information, an overview in understanding the ML roles a wide spread range of most ofte installed scenarios and their related settings.

BeoLink Multiroom scenario 2-2-0

NL TV in integrated setup with BeoSound 9000. BeoLink Converter NL/ML is V Master and with NL/ML Delay Box to connect to BeoLab 3500 and other NL product(s) in individual room(s).

Note

As BeoSound 9000 will not change between summer/winter time it is recommended to set Clock Master in the BeoLink Converter NL/ML that handles this setting automatically. The BeoLink Converter NL/ML then has the highest priority. See [page 33](#).

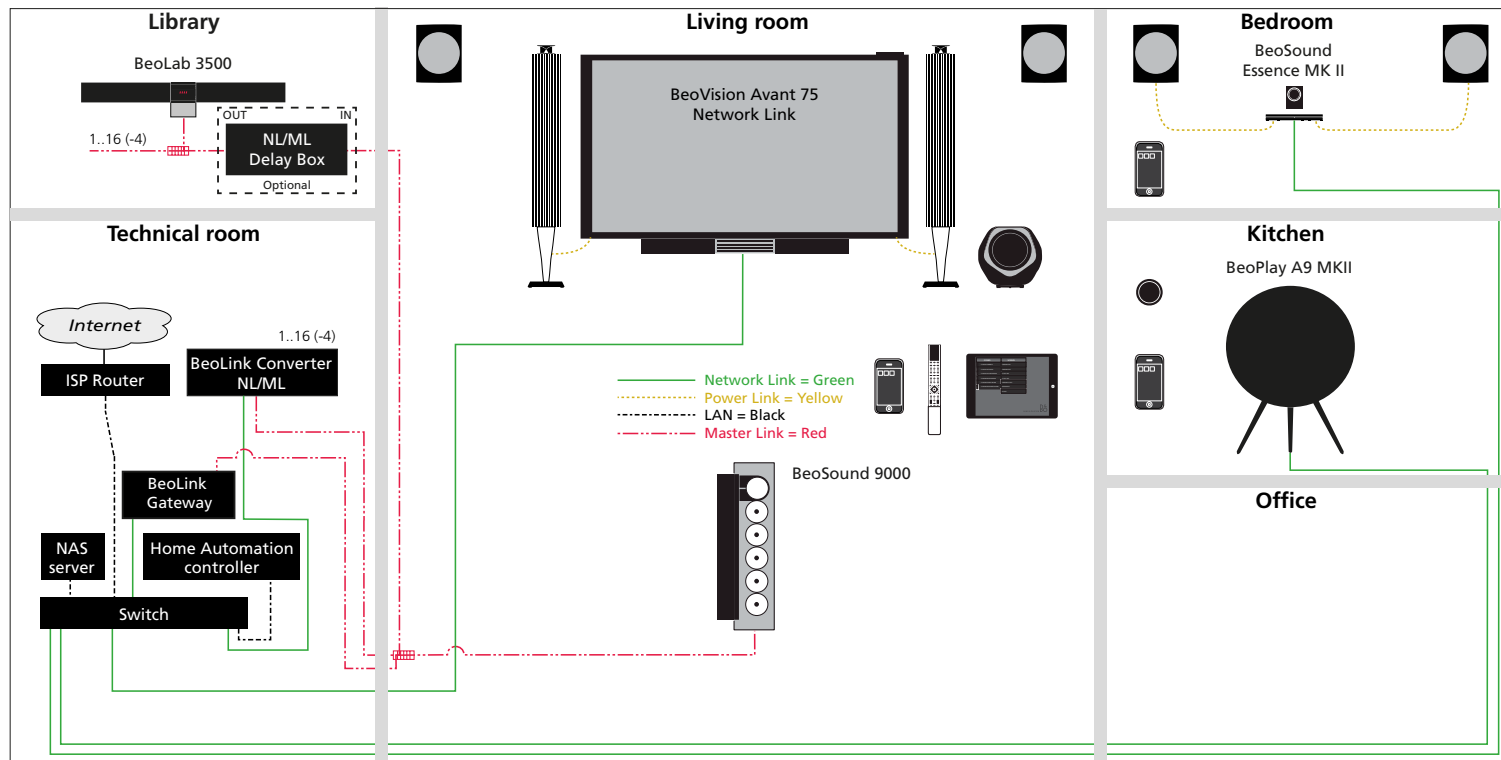

Settings in products

	BeoVision Avant 75 Living room	BeoSound 9000 Living room	BeoLink Converter NL/ML Technical room	BeoLab 3500 Library
Link to other products	Prod 1: <BeoLink Converter NL/ML Technical room> Prod 2: <BeoPlay A9 MKII Kitchen>		Primary: <BeoVision Avant 75 Living room> Secondary: <BeoLink Converter NL/ML Technical room>	
Is Audio product in same room as this TV	Yes			
Use TV speakers as the only speakers for the Audio product	Yes			
Speakers used with	BeoLink Converter NL/ML			
Option	(2)	0	(NA)	6
ML role		(A Master)	V Master	
Clock Master			Enable (See note)	

BeoLink SmartHome - an overall description

Only one-remote! Combine your A/V system with your home automation solutions and stay in control with only one remote. Seamless and hassle-free integration of the Bang & Olufsen BeoLink system and a wide range of Home Automation partner systems with the BeoLink Gateway.

Use your Bang & Olufsen remote, your BeoLink App or even the home automation panel on the wall, it is entirely up to you how you want it. We combine full control with extreme flexibility and convenience.

The BeoLink Gateway is a serious contributor to all Bang & Olufsen core customers who are looking for an increased experience within:

- Comfort
- Simplicity
- Efficiency
- Security
- Ease-of-use
- Flexibility
- and last but not least, fun, ambience, and atmosphere.

The BeoLink SmartHome solution provides remote access on a secure connection to your entire system.

To enable BeoLink SmartHome it is required to include the BeoLink Gateway. By this it is possible to create and control the scenarios you prefer: Easy programming, easy maintenance and easy updates.

Remote control and operation panels

Customers can choose freely among the control devices they want to use in the home. Any Bang & Olufsen remote control, the BeoLink App for your smartphone or tablet, a dedicated Automation panel, or a dedicated web panel for use in any web browser e.g. your TV screen, your computer or your tablet.

You can programme different scenarios combining both A/V equipment and home automation activations. This may involve setting specific timers on certain actions to get one-touch operation of a programmed sequence.

A large number of commands can be combined in one room, as you like. They can be categorised as local commands and global commands or a combination of these.

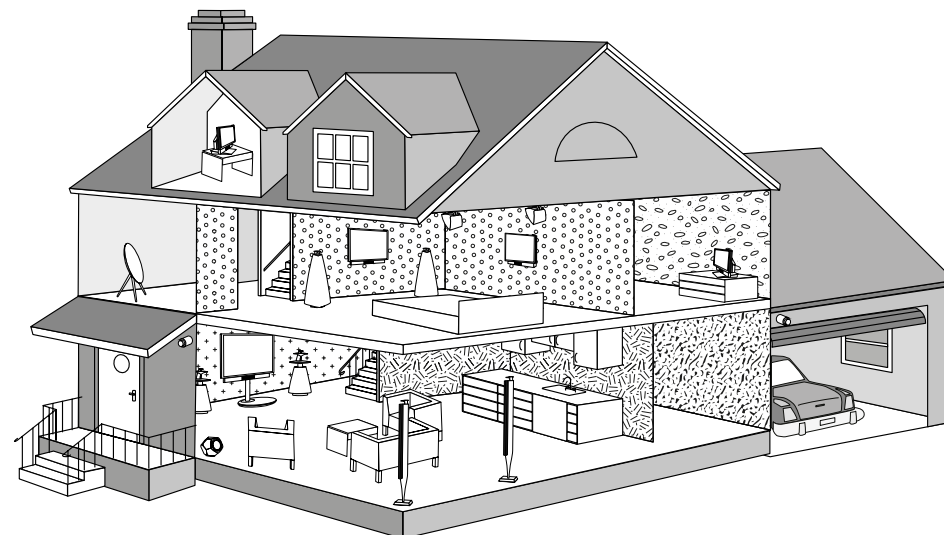

The BeoLink Gateway

The BeoLink Gateway makes it easy to create scenarios, rooms and areas of the house with simple programming and pre-installed drivers from many home automation suppliers.

The BeoLink App automatically replicates system settings (favourites, users, zones, virtual buttons etc.) and makes the control of the entire home simple and convenient for the user to use.

The SmartHome panels, which is a built-in web server, allows for any web browser e.g. via the TV, a tablet or a computer, to give a simple control of all scenarios and/or home automation device within the entire home. You can get overview/status of the home and all zones/rooms that can be controlled including two way feedback from the SmartHome systems. This also includes IP cameras that can be viewed and controlled from the SmartHome panel or the BeoLink App.

Connections

Connect to:

- Master Link using Master Link plug or RJ45 for Master Link.
- Network Link using RJ45 for Network Link.
- RS232 using USB A connectors.

The BeoLink Gateway is a gateway between BeoLink (both Master Link and Network Link) and many different home automation systems on either RS232 or IP based protocols. You can connect as many different home automation systems as you like and even use the BeoLink Gateway as an integration point between these systems.

In case a specific driver is not present in the BeoLink Gateway, an interface can be made via the custom strings or a new driver can be programmed using the open source LUA scripting language.

New advantages of the BeoLink Gateway

- General rules can now be added, so macros do not have to be built from scratch for every zone.
- Possibility to add waiting times for each command in a macro.
- Possibility to use astronomic clock for timer events.
- Drivers are written by use of "LUA" scripting language, which makes drivers independent of SW releases.
- The BeoLink Gateway knows what it is doing – for most drivers it can tell the difference between a switch and a dimmer. This is used when creating User Interfaces in the SmartHome panel and to ease installation.
- Two-way feedback from all home automation systems via App, presenting status and ongoing experiences.
- SmartHome panel instead of Web panel – is now built in HTML5 resulting in a much better user experience
- Possibilities to make use of CSV files in the programming to make it easier to maintain and copy from setup to setup (e.g. an installer can now have a basic CSV file for favourites and just copy it into the BeoLink Gateway).
- A house can be divided into Areas that contains several zones. This makes it easier for the programmer to keep track of everything and easier for the customer to operate the system.
- Live update of programming – a change will happen immediately in the system – no need for pressing "Test" or upload programming.
- Several programmers can work simultaneously on the same setup.
- Indicator telling whether a resource (BeoLink or Home Automation system) is active or not reachable.

- A new benefit for the demo of integrated systems within Bang & Olufsen is "the Immersive Experience". It is a built-in auto demo that e.g. can be used within the stores where the BeoLink Gateway combines a movie with a script that can execute commands (either macros or direct defined resources). This can be used for example on the solution walls with one of the integration movies from Bang & Olufsen, or it can be used elsewhere with any movie and a combined script defined by the custom installer.

Home Automation - suppliers

The BeoLink Gateway works with equipment from the below suppliers (and more to come):

- | | | |
|-------------------------------|--|----------------|
| - Crestron | - Vantage | - Control4 |
| - Savant | - Velux | - Beckhoff |
| - Clipsal | - AMX | - Nest |
| - Conson Concept XP | - RTI | - Phillips Hue |
| - Custom Strings | - Global cache | - Smart House |
| - Dynalite | | |
| - KNX (EIB KNX, Busch Jaeger) | - LK IHC (Intellegent House Control, Viewer models only, LexControl) | |
| - KNX (FT 1.2, PEI-IOmode) | - Lutron: Grafik Eye (GRX), Grafik QS (QSE), Radio RA | |
| - KNXnet (IO tunneling) | - Lutron: Home Works, Home Works QS, Home Works Radio Ra2 | |
| - Legrand Bticino | - Lutron Home Works Interactive | |

See also [BeoWise > 3rd party products > Home Automation](#).

One-remote

One-remote has been a natural way to handle all products in a Bang & Olufsen system for more than 3 decades. This means that the same remote or same type of remote acts the same way, regardless of whether it controls an audio or a video setup. Sometimes it may be advantageous to have more remote controls - maybe one for each room - but the benefit is that the operation is the same well-known in all situations.

For many years Bang & Olufsen has also integrated control of 3rd party products, into the one remote concept. This is made possible by use of Peripheral Unit Control (also called the PUC); see [page 181](#).

The remote control can be Beo4, Beo5, Beo6 or newer Bang & Olufsen remote controls or any mix of these.

In addition to the remote control, we have also made solutions to be used on smartphones and tablets; the BeoLink App is made for the iOS platform and works in both smartphones and tablets. With the BeoLink App you can control both your entire BeoLink (AV) system and your home automation system.

The BeoRemote App used on iOS or Android tablets is another example of remote control app. It gives you convenient access to Smart TV, a QWERTY keyboard, and is used for source selection, navigation (volume, source and zone) and source control.

Apps are useful additions to the remote control, and the following apps are available:

- The BeoLink App for iOS devices is focusing on whole home operation.
- The BeoRemote App for tablets is focusing on TV operation and connected sources in one room.
- The BeoMusic App is focusing on audio experiences.
- BeoTool: see [page 158](#).



PUC

Usually 3rd party products, such as DVD-players, Blu-ray disc Players, Game consoles, Set-top Boxes, Projectors, Audio or Video media storage devices, media players, are controlled by their individual remote control.

In a Bang & Olufsen system we want to operate all the products with just one remote control - the desired Bang & Olufsen remote control. To be able to do this we have the "PUC control". PUC is short for Peripheral Unit Control. In the PUC system all Bang & Olufsen TV's are able to control many different IR controlled A/V sources.

IR-blaster/IR control cable

With the PUC control or the One-remote solution, an IR-blaster cable is connected to the Bang & Olufsen TV via a Mini Jack or RJ45 connector and the IR blaster is connected to the 3rd party A/V product.

The Bang & Olufsen PUC control even works in a system where all the A/V sources are connected to an HDMI switch matrix (used in situations where HDMI signals are needed to be distributed to different zones). In such a case the control of the HDMI switch is also build into the TV via the PUC control. HDMI switch matrixes may be advantageous both if you want to distribute high-definition video sources to other rooms or if you want to simplify the number of source equipment and cabling in each room. See [page 35](#).

Active Infrastructure - an overall description

Network Link is a network consisting of Bang & Olufsen products connected to Bang & Olufsen recommended network active infrastructure and network devices. To give the best experience to our customers Bang & Olufsen has carefully chosen and thoroughly tested this network infrastructure. Only the recommended 3rd party products should be used to ensure an easy and problem-free setup and to give the best possible experience to the customer.

Reading guidelines:

- Two network scenarios are dealt with in the following. Read and understand the differences of both scenarios to choose an appropriate solution to fulfil the customers needs.

Note: the Basic Network setup is described first, followed by the slightly more complex Bang & Olufsen network setup - i.e. to go from the simple to the more complex.

- The term ISP Router is used for the router that is part of the customer's home network and which is usually delivered by the Internet Service Provider. This kind of router often includes function as modem, router, switch and access point.
- The term B&O Recommended Router is used for the Bang & Olufsen approved router that is part of the Bang & Olufsen Network setup, see [page 53](#), when a separate sub-network is needed. This is due to experiences where the ISP Router is causing varying quality in terms of securing stable connection and distribution between products in the Bang & Olufsen setup.
- In the two scenario the products are wired together in order to achieve the most stable network performance and best possible experience on the home audio/video system. Wireless connections are of course possible although dropouts may occur.
- Please note that all screen shots of web interfaces shown in this handbook, are only examples. Therefore, the actual web interfaces that need to be configured may look different.
- Technical specifications, features and the use thereof are subject to change without notice!

Basic Network setup

It is often sufficient to build a Network Link setup based on the ISP router as seen in the illustration. Today most ISP routers are stable and deliver high and robust connections in and out of the Internet and between products connected in the internal setup. A switch is applied when more LAN/Ethernet connections are needed. These are used both for Ethernet connections and Network Link connections.

This scenario may have advantages when a Home Automation controller, a NAS server and a BeoLink Gateway or a Master Link gateway is to be accessed from a device using the BeoLink App.

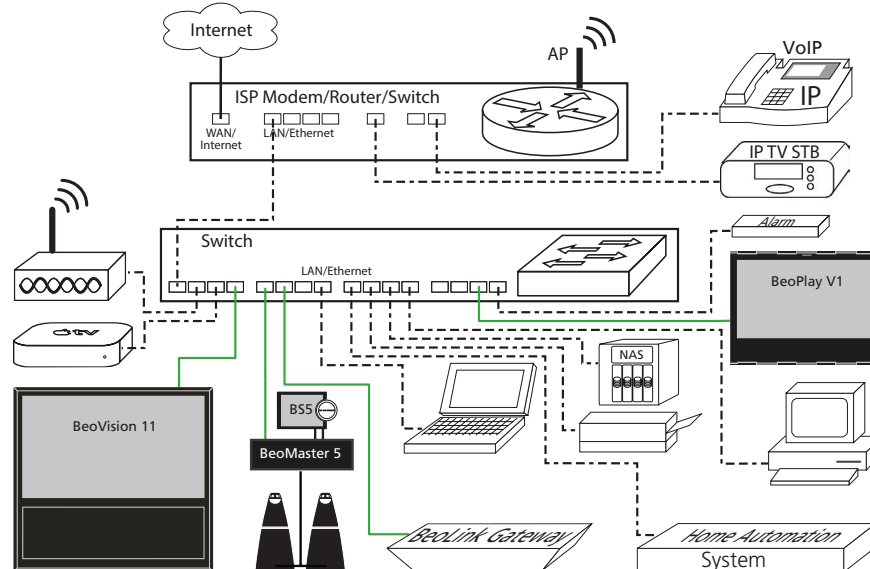

Bang & Olufsen Network setup

To obtain a stable network with well known IP addresses the network setup shown in the illustration should be used. A Bang & Olufsen Recommended Router is placed between the ISP Router and the distribution switch that serves the handling of products connected in a network; see recommended network products at: **BeoWise**, and open 3rd party products > **Active Network Components**.

This scenario is recommended as it is stable, tested and provides constant IP-addressing and is independent on break down or instability of the ISP Router. Bang & Olufsen cannot guarantee malfunction of e.g. streaming through the ISP Router like net-radio, video streaming and external link synchronization.

Consequently it is recommend to use Bang & Olufsen Network products and Bang & Olufsen recommended devices on a separate subnet to guarantee stability, performance and robustness within a Bang & Olufsen subnet; see [page 56](#).

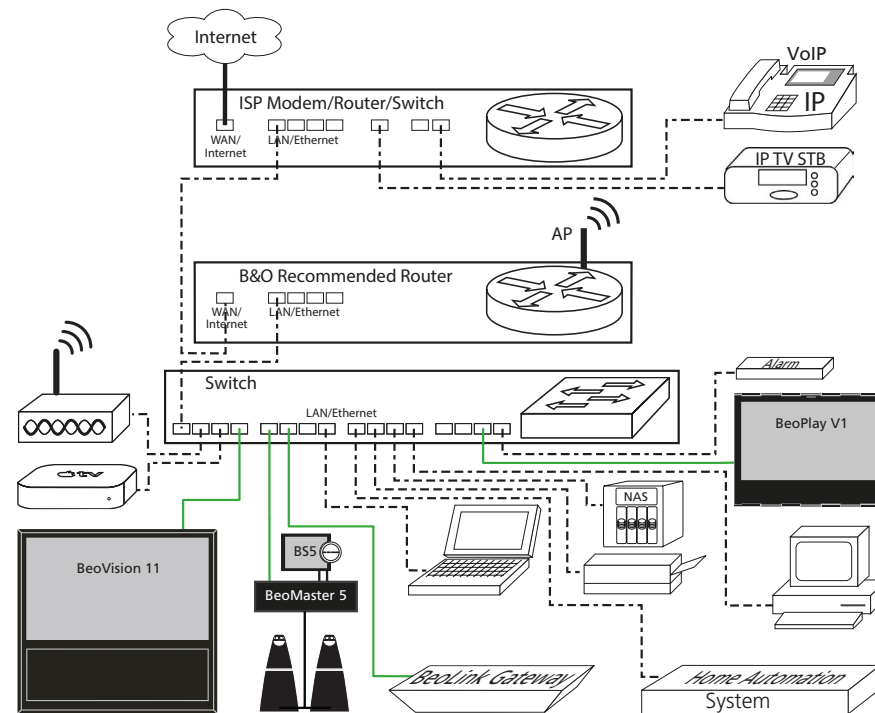

ISP Router settings

Bridge mode

When introducing the B&O Recommended Router it is recommended to set the ISP router in bridge mode. By this the B&O Recommended Router has the router function in the network. Setting the ISP router in bridge mode can be made either by the installer or requested through the provider of the ISP router. It is also recommended to have the Access Point function disabled.



The advantages of setting the ISP router in bridge mode are:

- A more simple setup.
- Avoiding two subnets, and consequently conflicts between the two routers.
- Easier setting up of port forwarding.

Non-bridge mode

Note: In case bridge mode setting is not possible, it is necessary to use the B&O Recommended Router as a subnet router. See [page 56](#).

Setting up the B&O Recommended Router

Depending on the setup, the B&O Recommended Router can be used as:

- A router.
- An access point (AP); see [page 65](#).

The following diagram illustrates the functional block diagram of a router. Please note that this is only an example, therefore the actual block architecture of the router may look different. ISP routers also typically includes a modem matching the connection type to the provider.

In the following sections you will be introduced to: - accessing the Web interface; - setting up the router connectivity and - setting up wireless.

Note: **Do not use the CD enclosed with the router.**

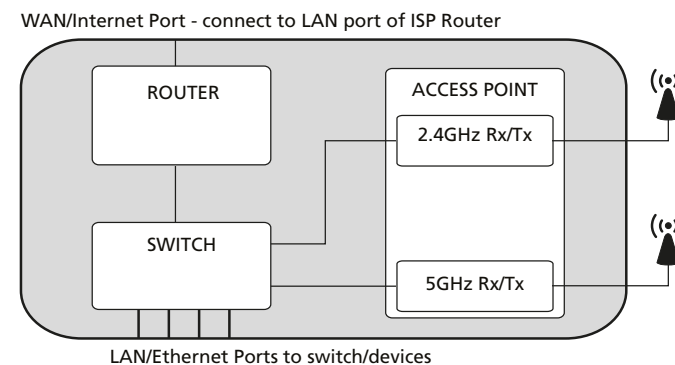

Accessing the Web interface

To access the web interface, switch on the computer while connected to the router.

- Launch the web browser on the computer, and enter the router's default IP address, e.g. `http://192.168.1.1` in the address field, followed by pressing the **Enter** button. A welcome dialogue appears. Set at check mark '✓' in the two check boxes and press **Next**.
- In the displayed dialogue **Linksys Smart Wi-Fi Sign In**, select an appropriate language.
- In the dialogue next to **For local access**, press **click here** to enter the local Sign In.
- Enter the default password (admin) and press **Sign in**. It is recommended not to change this password; see [page 68](#).

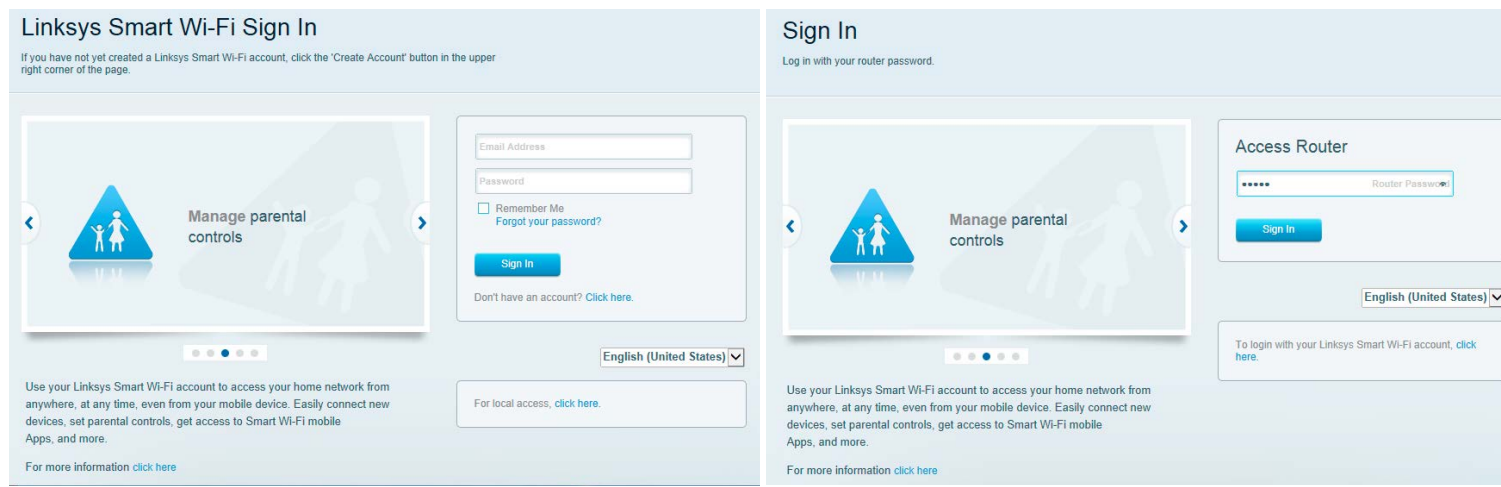

Setting up the router connectivity

Two scenarios exists for the functions of the ISP router and the B&O Recommended Router:

- ISP Router in bridge mode and the B&O Recommended Router has the router role. Bang & Olufsen recommends setting up the router with a well known - private - IP address, and the settings are made in a similar way as setting up a subnet.
- ISP Router in **non-bridge** mode i.e. works as a router, and the B&O Recommended Router has the role of a second router. To avoid conflicts the B&O Recommended Router must be assigned its own subnet (2nd subnet). A subnet, describes a logically address range. In this way the network traffic meant for the 1st subnet will not interfere with the 2nd subnet and therefore not overload the 2nd subnet.

Connect the WAN port (marked with WAN or Internet) of the B&O Recommended Router to one of the LAN ports (marked with LAN or Ethernet) of the ISP Router using a Cat 7 cable.

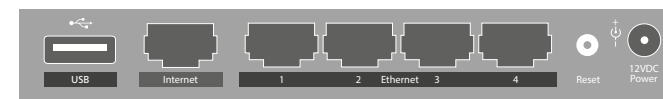

The Bang & Olufsen products and devices can be connected to any of the Ethernet ports on the B&O Recommended Router, and if necessary the 4 ports can be extended by adding a Bang & Olufsen recommended switch to the router.

Subnetting

When the ISP Router is in non-bridge mode it will use an address range within one of the following subnets: 10.0.0.x, 192.168.0.x, 192.168.1.x or 172.16.0.x. To avoid conflicting with these addresses, the B&O Recommended Router must be configured with a different address range (subnet) than that of the ISP Router.

Bang & Olufsen recommends to use the address range 192.168.100.x. Whenever possible, use the address 192.168.100.1 for the router.

When the ISP Router is set to bridge mode, there will be no address conflicts. To easy settings Bang & Olufsen recommends to use the address range 192.168.100.x.

- Access the Web interface; see [page 55](#).
- In the welcome dialogue press **Connectivity** in the left column.
- In the **Connectivity** dialogue, press the **Edit** button next to **Router Details**.
- In the **Host name** field, enter a name (of own choice) for the router.
- In the **IP address** fields enter the IP address for the router (e.g. 192.168.100.1) and a **Subnet mask** of 255.255.255.0,

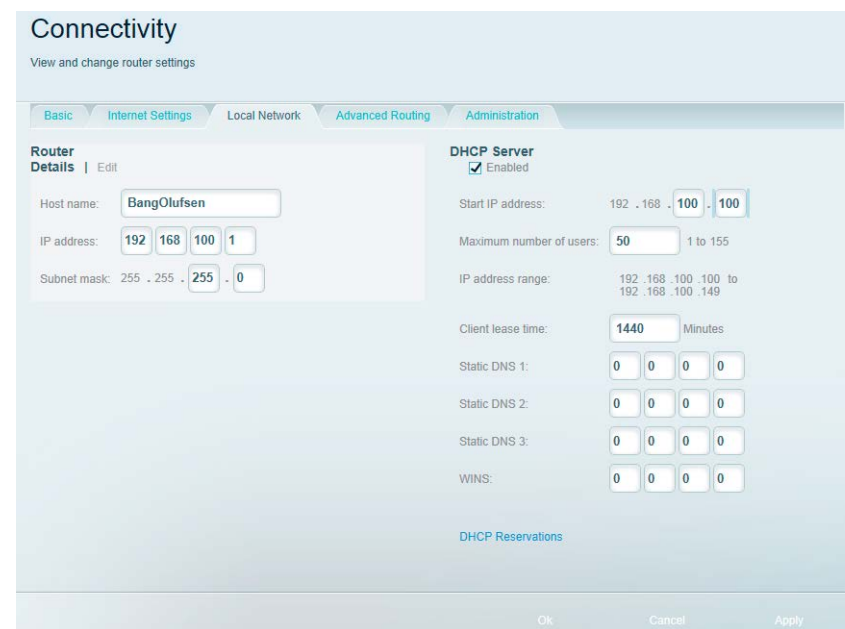

by which the subnet is defined.

- Place a check mark '✓' in the check box next to **DHCP Server** and enter a **Start IP address** (e.g. 192.168.100.100) and the **Maximum Number of users** (e.g. 50), by which the addresses that can be allocated by the DHCP server is defined.

Other settings are made as desired.

- Complete the settings of the router by pressing **Apply** or **OK**.

Wireless setup

The wireless settings in the router is made as follows:

- Access the Web interface, using the assigned IP address (e.g. 192.168.100.1); see [page 55](#).
- In the welcome dialogue press **Wireless** in the left column.
- Press the **Edit** button below **2.4 GHz network** and below **5.0 GHz network**.

- Enter a **Network name (SSID)** to both networks of own choice. Observe the following:

- The name can be up to 32 characters in length.
- The ASCII characters from 32 to 126 (incl.) can be used. Bang & Olufsen recommends that the default wireless network name is changed to a unique name. It is recommended not to include personal information in the Network name, such as Social Security numbers, since this information is available for anyone, searching for wireless networks.

Consider the following:

The Network name (SSID) can be the same for both the

2.4 GHz network and the 5 GHz network, by which the network with the best signal strength and accessibility will be chosen.

The Network name (SSID) may also be different for the 2.4 GHz and the 5 GHz networks.

- Enter a **Password** to both networks of own choice. The same conditions mentioned above re. the **Network name** also counts for the **Password**. It is recommended to use a strong password, which means it must consist of: - 8 characters or more; - mix of lower case letters and upper case letters; - numbers; - symbol characters.
- Set **Network mode** to **Mixed** for both networks.
- Set **Security mode** to **WPA2 Personal** for both networks.
- It is recommended to leave the **Channel width** field set to **Auto**.
- It is recommended to leave the **Channel** field set to **Auto**.

Other settings are made as desired.

- Complete the settings of the router by pressing **Apply** or **OK**.
A **Disconnect Warning** will appear. Press **Yes** to accept, that the router disconnect possible connection sessions after which the router will reboot.

Label

Place a label under the router with information about the SSID, the new password and IP address for the router.

Channel selection

Wi-Fi access points divide their frequency bands (2.4 GHz/5 GHz) into several smaller channel frequency ranges. For instance, the 2.4 GHz is divided into 14 channels. Channels are overlapping and can be chosen during setup.

2.4 GHz band

The 2.4 GHz band is susceptible to interference from Bluetooth® wireless enabled devices, cordless telephones, microwave ovens, baby monitors, and other household devices.

If more wireless transmitters are placed, e.g. additional access points it is advisable to either choose "Auto channel" or select channels that are not overlapping each others, e.g.

channel 1, 6, 11. Each channel has a bandwidth of 22 MHz. Routers can be configured to merge two or three channels to obtain higher bandwidth, however disadvantages can be difficulties to get at free channel due to interference from other 2.4 GHz transmitting systems.

Note: See [page 155](#) for troubleshooting if drop outs are experienced.

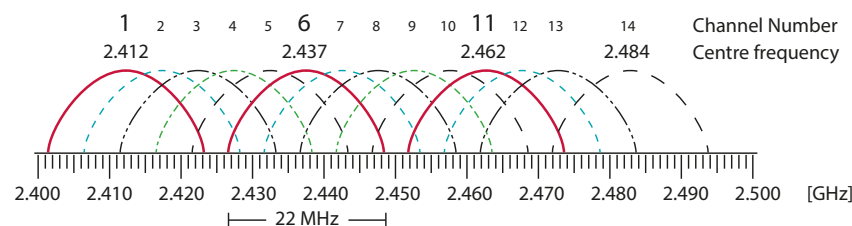

5 GHz band

The 5 GHz band consists of non-overlapping channels and is consequently less vulnerable by other equipment, although other transmission systems may use the same channels. The channels numbered 36 to 48 and 149 to 165 (incl.) are free channels. The other channels (DFS channels) are used by equipment certified for the purpose. The DFS channels may be used when free and the automatic channel selection system must choose another channel when a transmitter that is given first priority starts transmitting, as e.g. a weather radar systems.

Note: Not all channels are legal to use in all countries; see [page 60](#).

Each channel has a bandwidth of 20 MHz. Routers can be configured to merge two or more channels to obtain higher bandwidth, however disadvantages can be difficulties to get at free channel due to interference from other transmitting systems in the 5 GHz band.

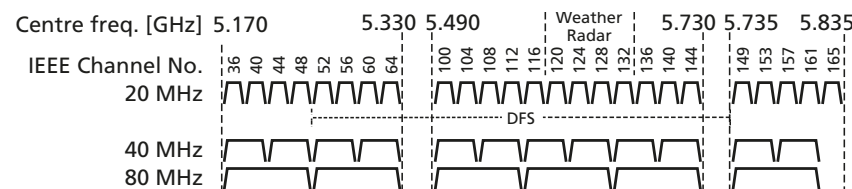

Wireless setting up conditions

Distance between 5 GHz transmitters

The number of 5 GHz transmitter systems in the near surroundings has impact on the stability as each transmitter occupies bandwidth and therefore in dense signal areas influence each other. To obtain the most stable wireless transmission, Bang & Olufsen has made a number of recommendations for the setup of transmitter systems.

A Bang & Olufsen stereo system setup or surround sound system setup is regarded as one transmission system and consists of a WPL transmitter and all WPL associated speakers. Similarly a 5 GHz Access Point and all associated computers is regarded a transmission system.

- The distance between a 5 GHz transmitter and a speaker must be no more than 12 m / 40 ft.
- The stereo/surround sound setup must be within an area of maximum 9 × 9 m / 30 × 30 ft.
- Transmitters and speakers must not be placed closer to other wireless units than 1 m / 3.3 ft.
- There must be no more than three transmission systems within an area called the 6 m / 20 ft zone, see illustration A. *

Power-up sequence

- In case of more Bang & Olufsen WPL systems in the same room, it is recommended to power only one at the time and wait at least 1 minute before powering up additional units.
- * In countries with less than 6 channels available, see [page 60](#), it is recommended to have only 1 additional transmitter system within the 6 m zone.

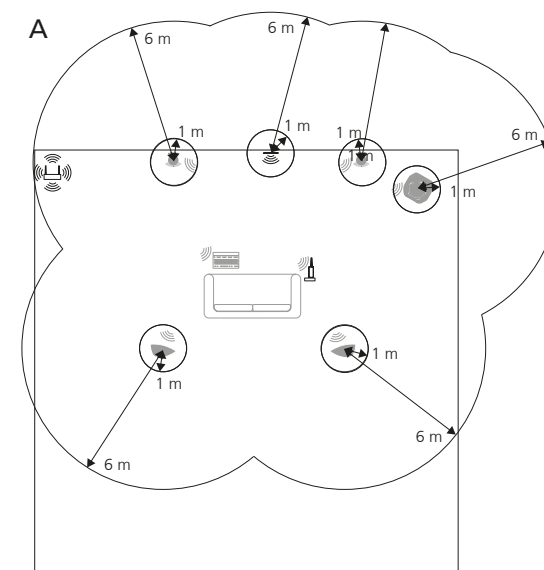

5 GHz channel pattern with respect to countries

The below table show combinations of 5 GHz channels used in various countries.

Channel pattern	↓ Countries	Channel number →	36	40	44	48	52	56	60	64	100	104	108	112	116	120	124	128	132	136	140	149	153	157	161	165	
HF1	Argentina, Brazil, Peru, Philippines, United Arab Emirates, Uruguay, Vietnam		█	█	█	█																	█	█	█	█	█
	Canada, Dominican Republic, Mexico, USA, Virgin Islands		█	█	█	█																		█	█	█	█
	Hong Kong, Namibia, South Africa		█	█	█	█																		█	█	█	█
	Australia, New Zealand		█	█	█	█																			█	█	█
	Thailand		█	█	█	█																			█	█	█
HF2	Andorra, Austria, Belgium, Bulgaria, Caribbean part of the Kingdom, Croatia, Czech Republic, Denmark, Estonia, Faroe Islands, Finland, France, Georgia, Germany, Ghana, Greece, Greenland, Hungary, Iceland, Italy, Latvia, Lebanon, Liechtenstein, Lithuania, Luxembourg, Monaco, Norway, Oman, Poland, Portugal, Romania, Saudi Arabia, Serbia, Slovak Republic, Slovenia, Spain, Sweden, Switzerland, The Netherlands, Turkey, Botswana, Ghana, Ireland, UK		█	█	█	█																					
HF3	Bahrain, Chile, Egypt, India, Malaysia		█	█	█	█																		█	█	█	█
	Panama		█	█	█	█																		█	█	█	█
	Singapore		█	█	█	█																		█	█	█	█
	Korea		█	█	█	█																		█	█	█	█
HF4	Azerbaijan, Israel, Kazakhstan, Morocco, Russia, Ukraine, Uzbekistan		█	█	█	█																					
	Kuwait		█	█	█	█																					
HF5	Côte d'Ivoire, Indonesia, Nigeria, Pakistan, Qatar																							█	█	█	█
	China																							█	█	█	█
																								█	█	█	█
HF6	Japan		█	█	█	█																					
HF7	Taiwan																							█	█	█	█
HF8	Jordan		█	█	█	█																					

Legend:	5 GHz channels	█
	5 GHz channels with radar detection (DFS)	█ Channels also not used with Wireless LAN module in BeoVision 14 and BeoVision Avant NG
	5 GHz channels not used by Bang & Olufsen BeoLab Transmitter 1	□

Due to national regulations, channels and channel patterns can not be chosen manually.

The transmitter is certified to use only specific channels in each country.

The automatic channel selection mechanism may in certain cases take more than 1 minute before a channel is allocated for sound transmission.

Note: It is recommended not to set BeoLab Transmitter 1 to ALWAYS ON:TRUE in countries having 5 or fewer 5 GHz channels.

In countries not mentioned above the HF 8 channels 36 to 48 may be compliant with local requirements.

Automatic or manual channel selection

If many Wi-Fi devices use the same channel they will interfere with each other, resulting in lower performance of the network or no connections. To avoid this, Wi-Fi devices can change the channel that they prefer to use. Channels can be chosen although Bang & Olufsen recommend to set the Channel field to Auto, as the router finds free channels automatically. The Manual Channel Selection should be used only for specific cases.

Channel selection/planning

When placing the access point or router the signal must be at least - 75 dBm when used with audio equipment. When a person is moving around in the room where the wireless equipment is placed the signal can easily drop 5 dBm. The wireless equipment might work on a signal as low as - 80 dBm, but you cannot rely on a stable connection with a signal that low. For full bandwidth - 65 to - 70 dBm is required. In most cases 'Auto' should be selected as 'Standard channel'. If manual channel selection is chosen in a Wireless setup, a number of wireless tools can be used to make the channel selection and planning, for example inSSIDer or Wi-Spy DBx.

Tools

The following sections describe how to use the wireless tools.

inSSIDer

inSSIDer is a free Wi-Fi network scanner for Windows 7/Vista/Windows XP.

- inSSIDer can be used to: Inspect the WLAN and surrounding networks to troubleshoot competing access points.
- Track the strength of received signal in dBm over time.
- Filter access points in an easy to use format.
- Highlight access points for areas with high Wi-Fi concentration.

inSSIDer can be downloaded from: <http://www.metageek.net/support/downloads>

WiFi Analyzer

The app named WiFi Analyzer from farproc is a freeware app for Android devices to show traffic intensity in wireless channels.

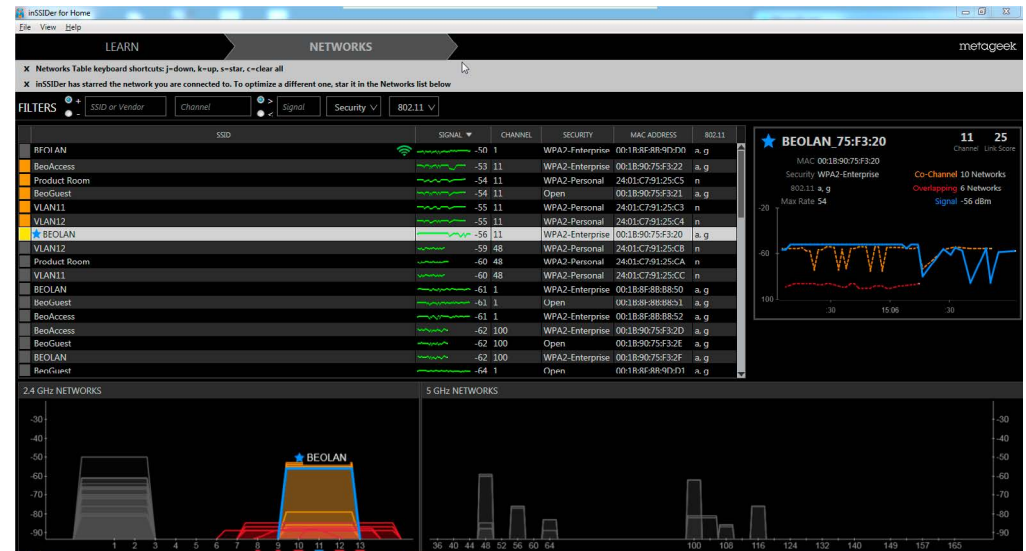

Wi-Spy DBx

Wi-Spy DBx is the professional spectrum analyser for IEEE 802.11a/b/g/n/ac. It is used to find interference in 2.4 GHz band (IEEE 802.11b/g/n) and 5 GHz band (IEEE 802.11a/n/ac). It can detect both Wi-Fi and non-Wi-Fi signals.

Features of Wi-Spy DBx tool:

- Optimise the network by automatically finding the best open channel for all different types of Wi-Fi networks.
- Avoid return trips to customer locations by determining whether there is persistent interference.
- Determine interference from neighbouring access points, microwave ovens, alarm systems and other wireless transmitting setups.
- Conduct site surveys; see [page 63](#).
- Chanalyzer Pro software presents the Wi-Spy data in several graphical formats for easy analysis and allows the user to move seamlessly between them.

For more details about Wi-Spy see: <http://www.metageek.net/products/wi-spy-dbx>.

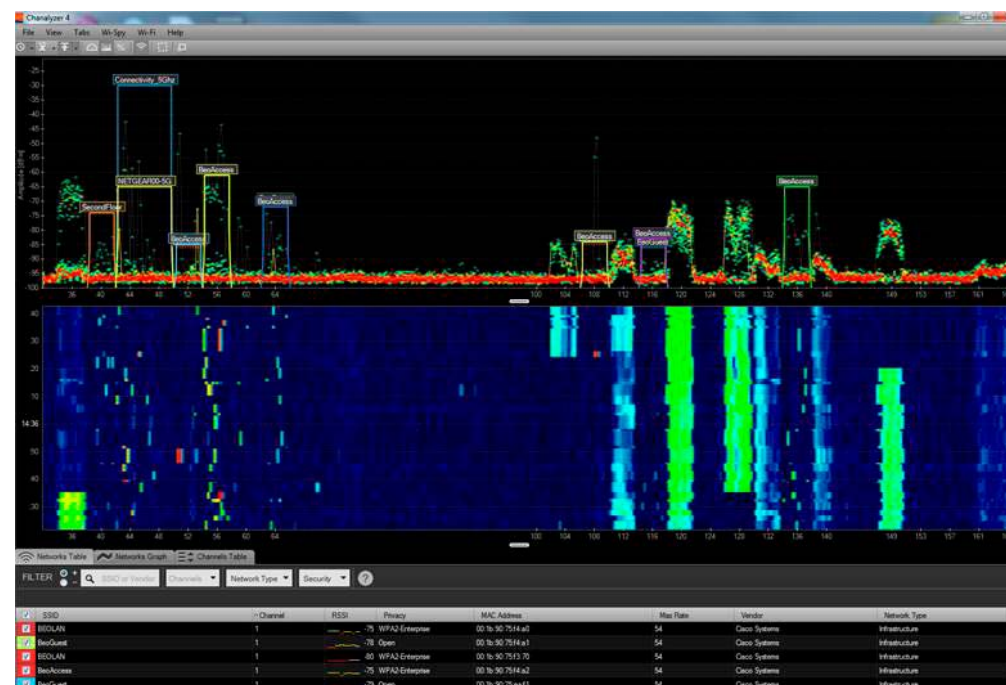

How to use Wi-Spy

Site survey (Wi-Spy)

Usually wireless speaker connections should not lead to problems. The Wireless Power Link Tx is able to find unused channels in the 5 GHz band, and makes a map of unused channels in case the present channel in use becomes occupied by another transmission system. In such case moving to an alternative channel happens seamlessly.

Despite this it is recommended to make a site survey in dense residential areas as well as enterprise areas, in countries with few channels (see [page 60](#)), in areas known for wireless problems and if many 5 GHz transmission systems nearby.



In a repair situation a site survey can also reveal if problems are related to lack of channels in the 5 GHz transmission system.

The Wi-Spy DBx + Chanalyzer Pro can be used to visualize which 5 GHz channels are used and unused.

Note: The free-ware program inSIDDer can show all channels or else use WiFi Analyzer App (for Android), and identify WLAN traffic, whereas it is not able to see radio traffic from other transmission systems using the 5 GHz band (see [page 60](#)).

Setting up Wi-Spy

From the Wi-Spy toolbar do the following (see example of Wi-Spy recording on the next page):

- Press **View** and select **Wi-Fi Channels**.
- Press **Wi-Spy** and select **Full 5 GHz Band**; to scan in the 5 GHz band.
- Press **Wi-Fi** and select the net board of your computer; in this example Intel(R) Centrino(R) Advanced-N 6205; to enable the on-board WLAN.
- Click on the  tool to have the Display selected networks (WLANs) enabled; by this the WLAN can be seen in the recordings.
- Click on the  tool to have Colouring by Density enabled.
- Set at check mark (✓) next to **SSID**, in the lower half of the display.

The total view will be as shown on the next page.

A recording is saved in the following way:

- Press **File > Save**, and remember to record where, when and how the recordings were made.
- State known wireless problems in the area, if any!

Observations for decision on wired/wireless

Make a Wi-Spy recording in the area where Wireless Power Link (WPL) is intended to be installed. Save the recording.

Compare the channel pattern for the country (see [page 60](#)) with the recording.

The possibilities for utilizing WPL are of course best when there are unused (free) channels.

If the recording seems to indicate that most/all channels are used, it might still be possible to utilize WPL, if the signal strength in some channels are below - 80 dBm. The channels can not be manually selected for the Wireless Power Link Tx.

Make a wireless test setup, and in case it behaves stable, make the installation permanent.

In case the test setup is unstable, or in case there are no unused channels, a wired solution is then the solution to a sound experience!

Port forwarding

Reach devices from outside the network

In case of access from outside the network to the BeoLink Gateway/MasterLink Gateway and other devices the port forwarding method must be used.

If the ISP Router cannot be set in bridge mode the following will allow for accessing devices connected to the B&O Recommended Router.

- In the ISP router make a DHCP reservation for the B&O Recommended Router.
 - Make port forwarding through the ISP router and through the B&O Recommended Router for the individual purposes. See Installation Guides for the routers and devices about port numbers and the setting of these.
-

Additional Access Points

Note: This section gives instructions on how to set up the router to work as an additional access point extending the local area network. This may be the case when the wireless part of the ISP Router or the wireless part of the B&O Recommended Router will not make a sufficient coverage.

A Wireless router can be set up and used as an access point. When a router is configured as an access point it is recommended to set the router in Bridge Mode. The access point is connected to the network using a Cat 7 cable connecting the WAN/Internet Port of the access point to one of the LAN/Ethernet ports of the B&O Recommended Router/switch.

Setup the router as an access point

When a Wireless router is set up as an access point, the 'access point' is connected to the B&O Recommended Router or switch as described above. Follow this step by step procedure below to set up the router as an access point:

- Connect a PC to one of the LAN/Ethernet ports of the 'access point'.
- Access the Web interface; see [page 55](#).
- In the welcome dialogue press **Connectivity** in the left column.
- Press **Edit** button next to **Router Details**.
- Set **Connection Type** to Bridge Mode.
- Select **IP Address** to be Specify an IPv4 address.
- Enter an IP address inside the range administered by the B&O Recommended Router and outside the range reserved for the DHCP server (e.g. 192.168.100.250).
- Set the Subnet Mask to 255.255.255.0
- Set the Default gateway to 192.168.100.1 (the IP address of the B&O Recommended Router).
- Set the DNS 1 to 8 8 8 8 - Google DNS (recommended).

Other settings are made as desired.

- Complete the settings of the router by pressing **Apply** or **OK**. A **Warning** will appear. Press **Yes** to accept. The router will then reboot and revert acting as an access point.

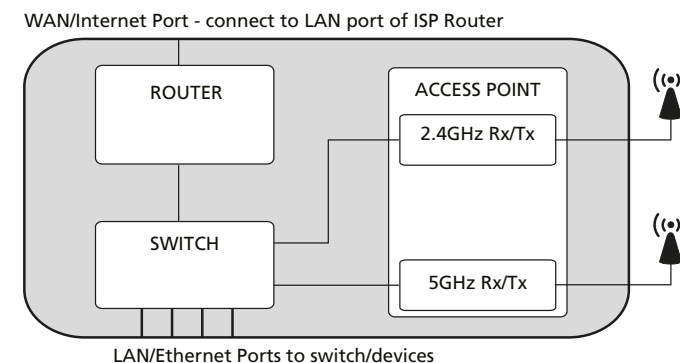

Connectivity

View and change router settings

Basic
Internet Settings
Local Network
Advanced Routing
Administration

Router Details | Edit

Host name:

IP address:

Subnet mask:

DHCP Server Enabled

Start IP address:

Maximum number of users: 1 to 155

IP address range: to

Client lease time: Minutes

Static DNS 1:

Static DNS 2:

Static DNS 3:

WINS:

DHCP Reservations

Extension of LAN using Powerline

Powerline can be a good alternative to wireless LAN or LAN cables. The Powerline network is extending the LAN outlets in the residence via the existing electrical mains wiring. The Powerline adapters are plugged into the mains outlet.

Various versions exists, providing e.g. Mains outlet (power socket), mains filter, wireless access point, 2 or 3 LAN sockets.

Up to 1200 Mbps wirelessly and up to 1200 Mbps wired, on a line of up to 400 m / 1300 ft.

More information is available on www.devolo.com/en and lookup Products.

Note: The dLAN 1200 series support IEEE 802.11 ac. The mains wires live, neutral and ground are used to obtain the increased data speed as possible. With live and neutral wire only, the data speed will however be reduced.

Products are ordered via BeoWise.

Please note: always connect product directly to the LAN port on the Devolo units; never connect an extra switch to distribute to more products!

dLAN® 500 duo, Starter kit

2 x dLAN® 500 duo adaptors each with 2 Fast Ethernet connections; without power socket outlet and mains filter.

Part No.	Description
8780052	dLAN® 500 duo, Starter kit (EU)
8780053	dLAN® 500 duo, Starter kit (UK)

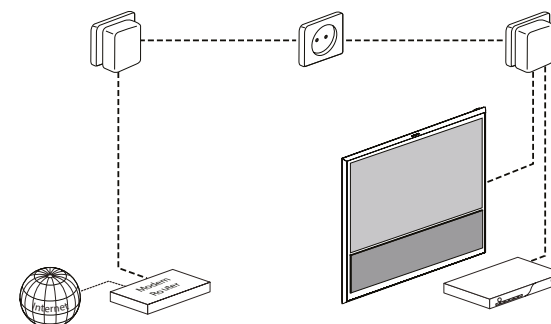

dLAN® 1200+, Starter kit

2 x dLAN® 1200+ adaptors each with 1 Fast Ethernet connections; with power socket outlet and mains filter.

Part No.	Description
8780103	dLAN® 1200+, Starter kit (EU)
8780104	dLAN® 1200+, Starter kit (UK)
8780007	dLAN® 1200+, Starter kit (FR, BE, PL, CZ, SK)
8780012	dLAN® 1200+, Starter kit (CH)

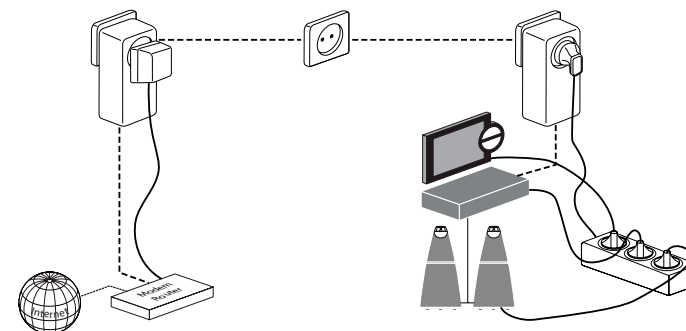

dLAN® 1200+ WiFi ac, Starter kit

1 × dLAN® 1200+ adapter with 1 Fast Ethernet connection; with power socket outlet and mains filter.

1 × dLAN® 1200+ WiFi ac adapter with 2 Fast Ethernet connections and wireless LAN; with power socket outlet and mains filter.

Part No.	Description
8780105	dLAN® 1200+ WiFi ac, Starter kit (EU)
8780106	dLAN® 1200+ WiFi ac, Starter kit (UK)
8780109	dLAN® 1200+ WiFi ac, Starter kit (FR, BE, PL, CZ, SK)
8780114	dLAN® 1200+ WiFi ac, Starter kit (CH)

dLAN® 1200+ WiFi ac, Single unit

1 × dLAN® 1200+ WiFi ac adapter with 2 Fast Ethernet connections and wireless LAN; with power socket outlet and mains filter.

To extend existing Powerline installations by adding 2 LAN and wireless LAN i.e. an extra access point.

Part No.	Description
8780110	dLAN® 1200+ WiFi ac, Single unit (EU)
8780111	dLAN® 1200+ WiFi ac, Single unit (UK)
8780108	dLAN® 1200+ WiFi ac, Single unit (FR, BE, PL, CZ, SK)
8780113	dLAN® 1200+ WiFi ac, Single unit (CH)

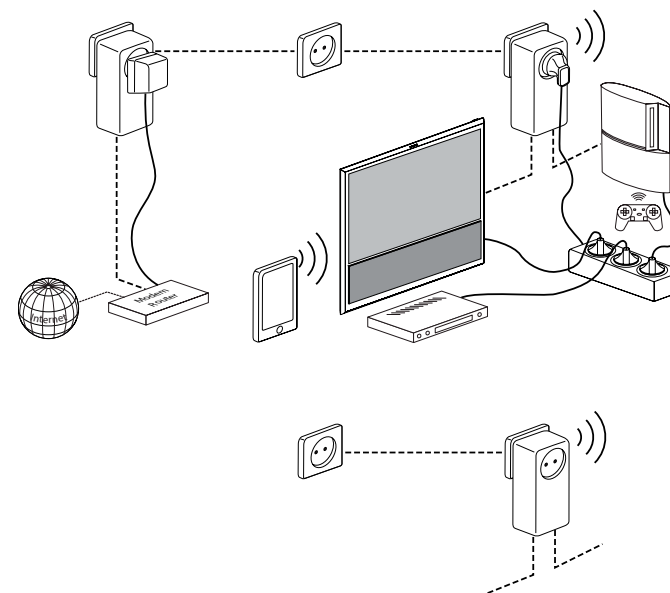

Nice to know - about wireless

Router login password

It is recommended, although not a must, not to use or change the login passwords of the router, based on the following reasons:

- To access the router settings, it is needed to establish a physical cable connection to the router, which is regarded a security matter itself - and consequently a password may not be needed.
- New service technicians may not know the password in a service situation, and have to reset the router instead. The consequences are loss of settings and unnecessary work to re-establish the router settings.

Wireless Limitations

There are several advantages offered by Wi-Fi wireless technology. The advantages include high mobility and flexibility. However, there are some limitations that must be addressed as well. Security and interference are the main issues with current Wi-Fi standards, as well as its inability to stream high definition audio and video in a reliable manner. Echo problems may also occur.

Maximum streams

To ensure the quality on audio streaming, do not attempt to handle more than 4 streams, on an access point.

Lack of support for high-quality media streaming

Even the fastest current Wi-Fi standards are pushed beyond their limits when trying to handle some of today's high-end media. High Definition (HD) audio and video files are bandwidth and time-delivery-intensive, and typical wireless networks have neither the transfer speeds nor the consistency to transfer them flawlessly. This proves even more problematic if there are multiple devices connected to the same access point because the bandwidth must be divided between all devices.

Wireless access point/router placement

In general the higher level of signal strength the better is the Wi-Fi network connectivity. If the SNR (signal/noise ratio) is above 25 dBm, the signal quality is good enough for a wireless product.

This section describes various factors that can affect Wi-Fi signals and its coverage. These points should be kept in mind while setting up wireless network in the customer's home.

Also, this chapter explains how to set up a Wireless network without the use of professional Site Survey/Planning tools. This could be the case in setting up a small and simple wireless network.

Conducting a Site Survey

One of the key factors in determining the success of a wireless LAN deployment is a site survey. Before deploying or expanding the wireless LAN, field technicians need to understand the needs of the users in the current environment.

By performing a site survey, a field technician can identify the obstacles to avoid, eliminate, or work around coverage patterns to decide the number of access points needed. The site survey should yield a layout document that describes the location of each access point and its coverage area. See about tools for site survey [page 61](#).

The following points can be of importance to maximize the signal strength and minimize interference:

Obstacles to signal strength

In general, objects can degrade or block the signal. Identify any potential obstacles or impediments in the area to be served. For example:

- Walls – especially if the wall is composed of heavier construction materials, such as steel reinforced walls in earthquake resistant buildings.
- Ceiling – particularly if they are made of material such as metal and steel reinforcement.
- Furniture – especially pieces that are largely made of metal.
- Natural elements – such as water, trees, and bushes – not only outdoors, but also in many lobbies, courtyards or other interior public spaces.
- Coated glass – transparent glass generally does not greatly degrade signal strength. But it may do so if it is coated with a metallized film or has a wire mesh embedded in it.

Signal noise

Noise from alarm systems, cordless phones, wireless headsets, and other non-protocol devices can interfere with an access point trying to send or receive data. The site survey should identify the sources of signal noise present in each deployment area so that the WLAN can avoid at least the already existing noise sources.

Use Wi-Spy DBx USB dongle and Chanalyzer Pro software on the computer to find out if there is any other equipment using 2.4 GHz / 5 GHz which may create interference. See [page 62](#).

Measuring AP signal strength

In conducting the site survey, first make sure that you have the proper equipment; see [page 61](#). This equipment can be relatively simple, including the access points, antennas, and wireless stations that will actually be used in the deployment.

Place the access point in locations where it is likely to achieve appropriate coverage and then measure the result. With the access point in a given spot, move the wireless station to various locations and measure the signal strength, noise level, and data rates produced. Take several measurements from each location to ensure consistent results.

Coverage and connections in local access network

Various methods may be used to extend the local area network for ensuring connection and coverage to the network products.

The placement of the wireless access point or router/switch is important, in order to ensure a good connection.

Preferred placement options:

- Near the centre of the house.
- Off the floor, ideally on a high shelf.
- As far as possible from other Wi-Fi routers in the environment (remember to set the channel on the Bang & Olufsen access point or Router).
- Away from cordless phones and microwaves, which operate on the same 2.4 GHz frequency and 5 GHz frequency. (There are some cordless phones that are Wi-Fi friendly).
- Keep antennas (access points) as far away from power cords and other computer wires as possible. Those cords and wires can interfere with radio reception.
- If one access point will not cover the residence more can be added to the router or switch.

Please use the same SSID and passkey, which will simplify the wireless setup on the products.

The Bang & Olufsen recommended routers support IEEE 802.11n and consequently 2.4 GHz and 5 GHz simultaneously. It is recommended to use same SSID and passkey in all router parts using the 2.4 GHz setup and another, same SSID and passkey with all router parts using the 5 GHz setup.

In order to obtain the best signal, you need to place the Wi-Fi devices as close as possible to one another and as far as possible from other wireless enabled devices that are not part of the setup. If the customer lives in an apartment or in close proximity to the neighbours, their wireless network can also be a source of interference. However, many newer routers automatically select the channel with the least amount of interference, ensuring the best possible connection.

An alternative to wireless access and/or LAN-cables is to utilize the Powerline solution; see [“Extensions of LAN using Powerline” on page 66](#).

Wireless survey, planning & installation

Setting up an efficient, robust and stable wireless network at the customer's premises is a big challenge. The following sections will introduce how to be prepared before going to customer's premises to make the setup.

Questionnaire to the customer

A number of questions are useful to answer in advance, in order to prepare a setup:

- Where do you live? (Mid town, outskirts, high-rise building apartment, etc.)
- Indoor environment? (Concrete, Type of walls, number of floors, number of rooms)
- Type of Internet connection?
- Floor plan
- Size of apartment/house?
- Alarm system present, if any?

Measurement in the customer's home

The following wireless tools can be used to identify the best way to make the wireless setup and identify sources of interference to the Bang & Olufsen setup.

inSSIDer

Use inSSIDer to find out channel availability and see the number of access points present in the range. See [page 61](#).

Wi-Spy DBx (Spectrum Analyser)

Use Wi-Spy DBx and Chanalyzer Pro to track radio activity and analyse interference in both the 2.4 GHz and 5 GHz spectrum. See [page 62](#).

Wi-Fi Coverage/Site Survey Tool

In Wi-Fi setups with more than 5-10 access points, it might be a good idea to use a Site Survey Tool. It may be a good idea to get professional help using these tools, since they are rather complicated to use and may require some practice.

Examples of the companies who have Site Survey Tool are:

- Ekahau's Site Survey Tool
- AirMagnet's Planner

Configuration and installation of Wireless infrastructure units

Follow the instructions regarding configuration of a B&O Recommended Router as an access point as described in "[Additional Access Points](#)" on [page 65](#). Connect the access point to the B&O Recommended Router or switch. Check that all access points are on-line and connect by cable.

Channel Planning

In small set-ups the selection 'Auto channel' is recommended. It is the default setting. If two access points placed close to each other use the same channel, it can take up to 20 minutes before one of them automatically change to a new channel. There should be at least 25 dBm in SNR (signal-to-noise ratio) on a product connected to a network through Wi-Fi. With 2.4 GHz systems (IEEE 802.11b/g/n) there shall be 5 channels between each access point; e.g. ch. 1, 6 and 11 may be used. With 5 GHz systems (IEEE 802.11a/n/ac) any channel may be chosen, although it is advisable to have 1 channel between two neighbour channels to avoid noise interference from the neighbour channels.

If there is a non-Wi-Fi interfering source in the frequency band e.g. alarm systems on 2.4 GHz, you must switch to manual channel selection on the access point. In setups with a large number of access points manual channel selecting may be a good idea.

Fault finding and troubleshooting on Wi-Fi

If the wireless network does not work satisfactory, you need to find out what causes the problem in the wireless network. The software tool Wi-Spy DBx or a channel re-planning, can be used to find the faults. Please find information in "[Wi-Spy DBx](#)" on page 62.

Channel re-planning

Channel re-planning should be carried out if the customer has problems with the Wireless Network.

The problem could arise from interference from electronic devices operating in the 2.4 GHz wireless range present in the customer's home or nearby. The problem could also be interference from neighbouring access points.

By default the Network Link router is configured for 'Auto Channel Selection'.

This means that if there is any change in the wireless environment causing heavy interference in the channel selected, the access point in the Network Link router should automatically move to another less populated channel. This should happen within 20 minutes. The access point cannot see interference from non-Wi-Fi radio signals, for example alarm systems and wireless surveillance cameras.

Channel re-planning should be carried out using the inSSIDer tool. If it is not possible to find a less loaded channel, it is a good idea to change the position of the access point. The Site Survey tool Wi-Spy DBx can also be used, in order to see interference from non-Wi-Fi signals.

ISP - interfaces

This chapter explains different types of Internet connections and how to setup the Bang & Olufsen Network depending on the type of connection. This makes it easier to choose an Internet connection from the options available.

Technologies used in access equipment and protocols delivered by the access provider are changing and improving rapidly. It must be investigated individually which solution offers the needed capacity. The access providers often offers test solutions to measure or monitor the capacity of the provided solutions. Also observe that compression technologies develops fast regarding how delivery to the content. Bear in mind that the home installation also plays a role in distribution and use of capacity. This is e.g. depending on connections made wired ore wireless.

Dial-up modem

This method of connecting to the Internet is the oldest and slowest method.

The advantage is that it is available in all places which also receive phone service. To use this type of connection a phone line must be connected to the computer and a modem is used to communicate through the phone line. While the computer uses the phone line, the phone line cannot be used to make calls. Therefore, many people use a second line dedicated directly to their dial-up connection.

MoCA/Cable Internet

The Multimedia over Coax Alliance develops specifications for home networking over in-home coaxial cable, which is commonly used for antenna connections to TVs, radios, and cable TV.

The goal of the Multimedia over Coax Alliance (MoCA) is to facilitate home networking on existing coaxial cable in the 1 GHz microwave band, using Orthogonal frequency-division multiplexing modulation. This cable can be used for data connections to televisions, set-top boxes, and other entertainment devices without the need for new connections. The MoCA technology makes it possible to distribute high-quality multimedia content and high-speed data.

MoCA is a non-profit mutual-benefit corporation with the purpose of developing and promoting specifications for the transport of digital entertainment and information content over coaxial cable. MoCA members have agreed, to license under reasonable and nondiscriminatory (RAND) terms, any intellectual property required for member companies used to implement the MoCA Specification.

Although MoCA today is an open standard, there is only one supplier of MoCA chip sets.

WiMAX

WiMAX is the abbreviation for Worldwide Interoperability for Microwave Access. WiMAX is a telecommunication technology that provides fixed and fully mobile Internet access.

Cellular Broadband (3G/HSDPA/4G)

The cellular broadband is very useful when there is a need for mobile access to the Internet. The coverage is often good in highly populated areas and it varies from country to country. 3G USB modems for lap tops has also become very popular. It can for example be used for connecting to the Internet on a boat, when it is near the coast.

Fibre

This method of connection is the fastest available for most private users. Fibre optic Internet connections work in the same way as DSL or Cable connections.

As with other high speed lines, the phone, the television, and the computer can be used at the same time. The fibre optics is a faster connection than both DSL and cable.

DSL

DSL is an abbreviation of Digital Subscriber Line, and is a family of technologies that provide digital data transmission over local telephone network using copper wiring. A unifying term is xDSL and varieties are ADSL, ADSL2+, VDSL, SDSL etc.

Satellite

Internet over Satellite (IoS) allows access to the Internet via a satellite that orbits the earth. A satellite is placed at a static point above the earth's surface, in a fixed position. Because of the enormous distances signals must travel from the earth up to the satellite and back again, IoS is slightly slower than high-speed terrestrial copper connections or fibre optic cables. Internet over Satellite can be used e.g. on a boat.

Passive Infrastructure

The Bang & Olufsen passive infrastructure concept ensures that one cable type can be used for transporting analogue signals like Power Link and Master Link as well as digital signal for Network Link, Ethernet and HDMI video distribution. Additionally it includes data transmission for control of the products.

The installation concept is based on Cat 7/Class F double shielded cable that has a very high capability for future use as well as a high resistance towards a noisy environment.

The following part of the BeoLink Manual deals with the installation principles of the passive installation concept.

Cable management/handling

To ensure a reliable system, it is important to follow a few guidelines during installation.

Cable - tying

When securing cables you must take care not to pull cable binders too tight. This can crush and damage the twisted cables causing a lowered bandwidth or cable failure.

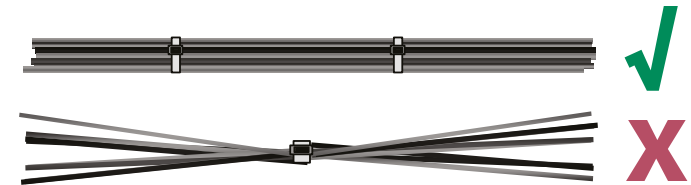

Cable - fastening

If mounting a Network Link installation or product cable directly onto the wall please use cable clips to avoid damaging the cable:

- 8 mm cable clip for Network Link installation cable
- 6 mm cable clip for Network Link product cable

Separation distance

The distance between mains AC power cables and Network Link installation cables must be greater than 50 mm (2") to avoid electromagnetic disturbance. Network Link installation cable must not run in the same conduit/cable duct as the mains AC power cable if using cable management systems such as flex tubing or conduit/cable ducts.

Pulling cables

Remember to use proper pull sleeve when pulling cable in tubes. If necessary use proper pulling compound. Do not use any kind of soap that can damage cables over time.

Outdoor installation



It is allowed to install Cat cable, Master Link cable, Power Link cable, IR-cable outdoor. In such case it must be protected against sunlight/UV light.

Extending cables

Some cables can be extended by adding extensions to the delivered cable or by replacing with other cable. See instructions for each cable.

Note: Never use soldering when extending cables and never use loose cable connectors. Instead use the recommended junction boxes.

Note: Network Link cables and Cat cables must run unbroken between two plugs/sockets.

Numbering of cables and connectors

Brackets for distribution centre cabinet are numbered 1 to 18 (1 to 24 for 19" bracket).
 To ensure you have a proper installation overview, and for future troubleshooting, wall plates must be numbered to match the number in the distribution centre.
 If more brackets are used a letter can be used as prefix for each number in the bracket and on the corresponding wall plate.

Bend radius

Generally

Minimum bend radius for Cat 7/Class F Network Link Product Cable Ø 6 mm/0.24" is 25 mm / 1".
 See [page 100](#); Part number 6250028.

Minimum bend radius for Cat 6A/Class E Network Link Plenum Cable (CL2P rated) Ø 6.55 mm / 0.258" is 30 mm/ 1.2" 150 mm / 5.9".
 See [page 100](#); Part number 6250030.

Minimum bend radius for Cat 7/Class F Network Link Installation Cable Ø 8 mm / 0.31" is 75 mm/3".
 See [page 99](#) ; Part number 6250027.

Note: Cables used dynamically (not in static installation) should have much wider bend radius and be handle carefully, not to harm the shield(s).

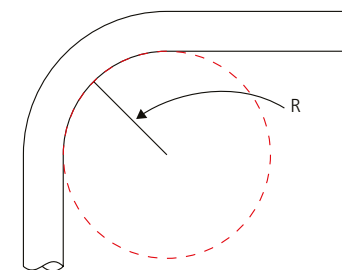

LK FUGA - in-wall units

Using the LK FUGA in-wall units must be of the 50 mm / 2" in depth type, and with soft bending conduits/channels in in-wall construction of minimum 140 mm / 5.5".

Note:

- The top most cable connector must be of the straight type.
- The lower most connector is recommended to be of the straight type.

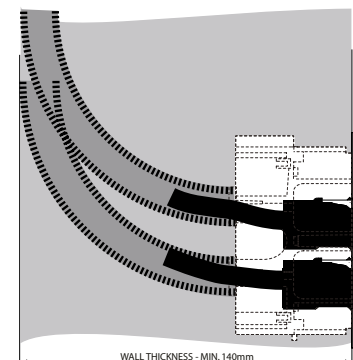

Shielding

Many cable types are shielded either using a foil or a braided shield or both. Shielding is designed to protect against intrusion of unwanted noise or cross over signals of various frequencies.
 It is important that foil and/or braid cores are not touching any wire cores. Also ensure that the outer braided shield is in good contact to the shielding in the connectors used, when present.

Noise reduction - Power Link

If the building/house is placed in an area with a lot of magnetic or electrical noise, a nanoperm coil can be used to significantly reduce the impact.

The coil is available as part number 6710038.

Place the coil somewhere between the Power Link output and the wall inlet RJ45.

The Power Link cable is arranged with 9 windings on the coil as seen in the illustration.



Original cables and connectors

Unoriginal cables and connectors exist both for Master Link cables and Power Link cables.

An increased number of fault reports has been experienced - caused by installations made with unoriginal cables.

Examination of unoriginal cables shows inferior quality in design and material used - cables are not in compliance with the Bang & Olufsen standards and requirements. Examinations are made by an independent test facility.



Findings: Missing or uneven isolation layers in the cables may cause data interference, signal dropout or even short circuit. Thin and uneven tin layers allow corrosion to occur.

It is strongly recommended to use original cables and connectors when making installations provided by Bang & Olufsen.

Cable length

The below illustration indicate the cable run in principle and the below table lists the maximum length of cable recommended.
 Note: Cable length is affected by passive and active devices being part of the cable run.

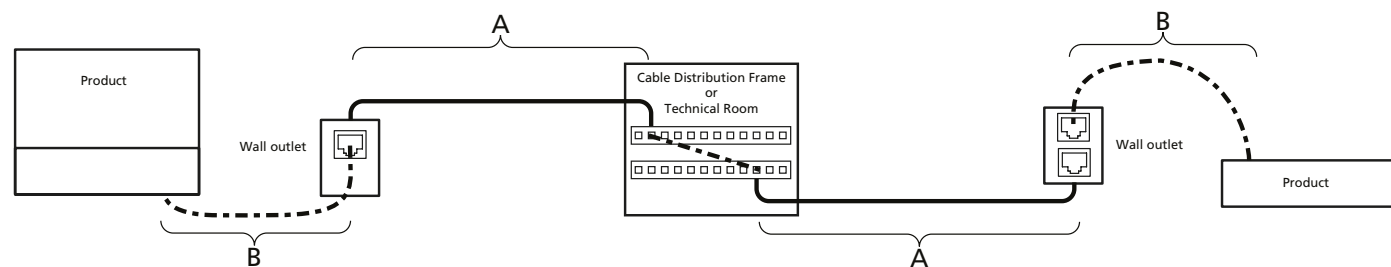

Type of cable and related maximum length of cable run	Devices used in Cable Distribution Frame or Technical Room	Length of Installation cable	Length of Product Cable
Network Link Installation Cable	Passive only	$A+A \leq 90 \text{ m} / 295 \text{ ft}$	$B+B \leq 10 \text{ m} / 33 \text{ ft}$
Network Link Installation Cable	Active devices	$A \leq 90 \text{ m} / 295 \text{ ft}$	$B \leq 10 \text{ m} / 33 \text{ ft}$
Master Link cable	NA	$A+A+B+B \leq 400 \text{ m} / 1312 \text{ ft}$	
Network Link Link Cable as Master Link cable	NA	$A+A+B+B \leq 1000 \text{ m} / 3281 \text{ ft}$	
Power Link Installation Cable (Ø 5.0 mm / Ø 0.2")	*	$A+A+B+B \leq 100 \text{ m} / 328 \text{ ft}$	
Network Link Cable as Power Link cable	*	$A+A+B+B \leq 300 \text{ m} / 984 \text{ ft}$	

* Max 10 speakers

Network Link cable run/ Cat

The total maximum length of Network Link Installation Cable (Cat 7) is 100 m / 328 ft; see table above.
 In exceptional cases the Network Link Product Cable may be used for in-wall installation although this is not recommended by Bang & Olufsen due to the quality and structure of the copper in the wires the total max length may be expected reduced to 50 m / 164 ft. See explanation [page 167](#) and [page 168](#).

Master Link

Master Link can cover up to 16 products, including the main room system's products.
 Maximum total length of cable run as Master Link; see table above.

Power Link

Maximum total length of cable run as Power Link; see table above.

IR cables - BeoLink Active / BeoLink Passive



The cable between the IR-receiver and BeoLink Active/BeoLink Passive is 5 m / 16 ft (supplied) and must not be extended. A special 15 m / 50 ft low-capacity cable can be ordered (see [page 120](#)), when the distance is longer than 5 meters. See mounting instructions [page 120](#).

IR cables - BeoLink converter NL/ML

A 10 m / 33 ft cable with RJ45 connector is included. In case cable extension or cable replacement is needed (total maximum 100 m / 328 ft), use any Cat cable and if needed a Power Link Junction Box. See mounting instructions [page 119](#).

IR cables - BeoSystem 3 / BeoSystem 4

Cables with dedicated plug is used. Network Link Product Cables are used for extensions up to 100 m / 328 ft. See mounting instructions [page 121](#) or [page 122](#).

Installation principles

Grounding - rules for Grounding

Important !
 Rules for grounding (earthing) must be followed closely.

! Grounding !



It is very important to ground the installation in order to eliminate any possible electrical hazard and to avoid noise in the loudspeakers.

All Network Link Cat 7/Class F and Cat 6/Class E installation concept components are shielded. If not grounded properly the customer can experience an electrical shock!

Always use the ground from an electrical mains installation.
 Always use the galvanic isolator if an external antenna signal or cable TV (CATV) is connected to the system. See [page 140](#).

Always remember that grounding of a Class 1 product is very important. Grounding through Cat 7/Class F and Cat 6/Class E cable is not sufficient. Class 1 products must be grounded according to rules of authorities. The Cat 7/Class F and Cat 6 /Class E shield and accompanied connections are not rated to function as safety ground, carrying the current needed to blow the mains fuse.

Primary goal of earthing/grounding

The primary goal of earthing/grounding is to protect the installation from electrostatic discharge and to protect the customer from electrical shock from the sum of leakage current from all the equipment connected to the network. The Network Link distribution centre must be connected to existing earth grounding installation in the building.

Example of structured grounding of Cable Distribution Frame/ Cabinet / 19" rack and galvanic isolator of antenna signal is shown in the illustration.

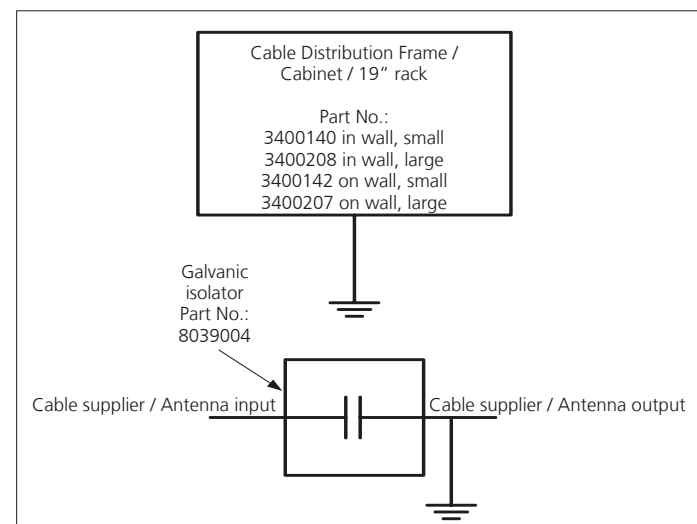

Technical room

It is often a desire that the products like TV, audio products and loudspeakers are visible, whereas all other equipment shall be hidden. For small installations discrete cabinets may be used and if possible a technical room is preferred to house all additional equipment. This covers Bang & Olufsen products that are part of linking the products together and to perform as desired. Additionally equipment are Cable Distribution Frames, Patch Modules, Network Link Brackets, 3rd party products, routers, switches, matrixes etc.

In certain cases it might seem practically to place equipment and devices (e.g. junction boxes, BeoLink Passive etc.) in a different place than the technical room, cabinet and so on. It is strongly recommended not to place such equipment at the loft and the like; see [page 89](#).

Note: the temperature may not exceed 40°C or fall below 10°C.

Cabinets/19" racks

All cabling leads back to a central place. This could typically be a technical room, equipment closet or another appropriate location.

19" racks are recommended and are ordered from a local dealer. Advantages due to sufficient space for a number of important items such as:

- 24 port switch,
- Server,
- MLGW,
- Switch matrix equipment,
- Patch Modules,
- Network Link Brackets,
- Possibilities for expansion,
- Well structured installation environment.

In case of large installations, it is possible to place more distribution centres in an installation (e.g. one on each floor).

- For Master Link: there must be a connection from centre to centre.
 - For Power Link: is done locally on each floor.
 - For Network Link: one router and a switch (and if appropriate a switch on each floor) used for the connection between the products.
 - For Ethernet: a switch must be placed on each floor and the 'input' cable must come from the router that provides the Internet connection.
-

Patch Modules

Patch Modules can be arranged in distribution frames and 19" rack.

Master Link

- Master Link Patch Module with 6 x RJ45 connections; see [page 136](#). 4 products can be connected to one module.

Example of how to wire a Master Link Patch Module; see illustration.

Note: To avoid problems with subsequent deadlock, always disconnect all Master Link products in the setup from mains before plugging Master Link Cables into the Master Link Patch Module.

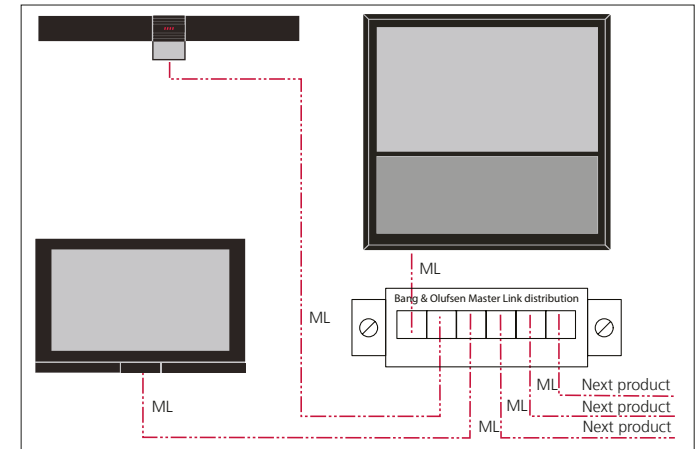

Power Link

- Power Link Patch Module with 6 x RJ45 connections; see [page 136](#). 2 pair of speakers can be connected to one module.

Example of how to wire a Power Link Patch Module; see illustration.

A subwoofer is often connected directly to the TV and placed near to the TV, however the subwoofer may be placed elsewhere and consequently the wiring may run via the Cable Distribution Frame where it is patched using the connectors in the bracket of the Cable Distribution Frame.

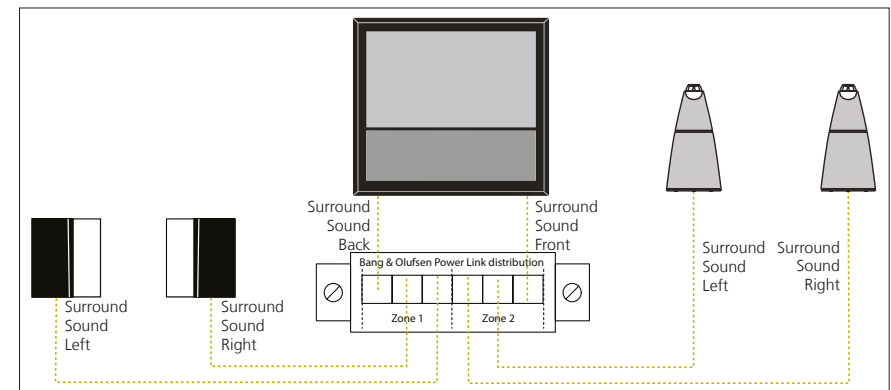

PL cable types and cable length

Example of cable types when setting up Power Link connections.

Visible product cables should be as short as possible. About cable length see [page 79](#).

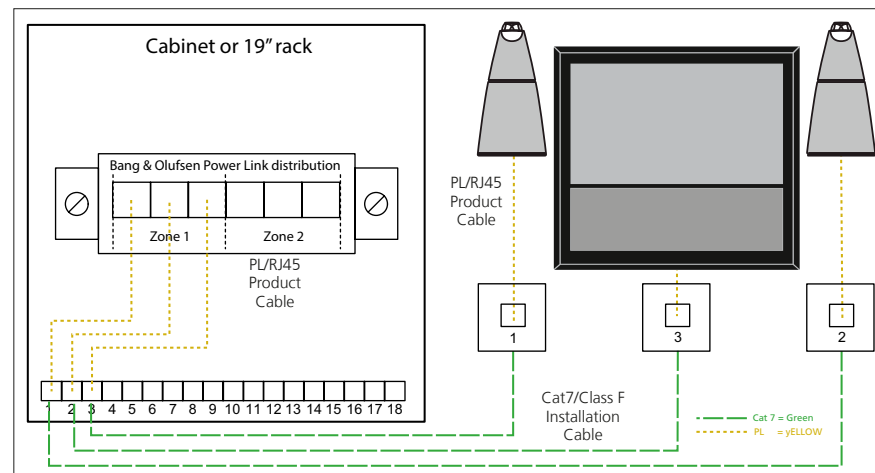

Non balanced speakers

Pre-ICEpower loudspeakers with non balanced input must be mounted with a special Balanced to non Balance Converter Box.

Part number 3376078.

Power Adaptor 12 V with EU mains plug is included.

This is only necessary if BeoLab loudspeakers without ICEpower amplifiers are used:

BeoLab 4000 MK I

BeoLab 6000

BeoLab 8000

Older active speakers

Newer speakers not using ICEpower technology.

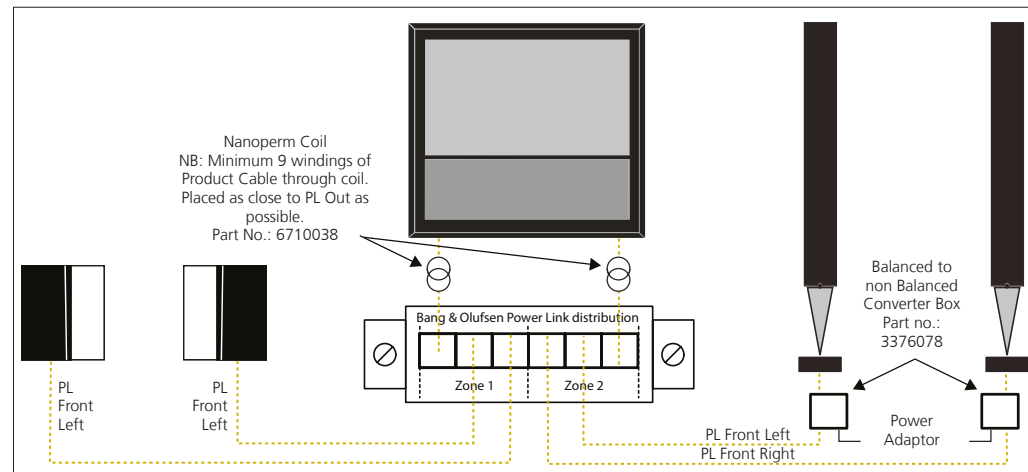

Splitter

Master Link

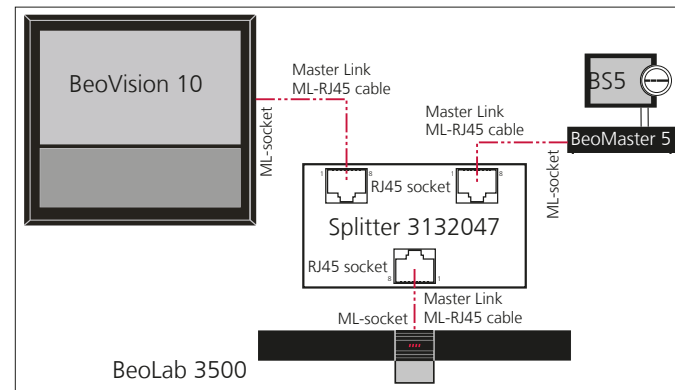

Power Link

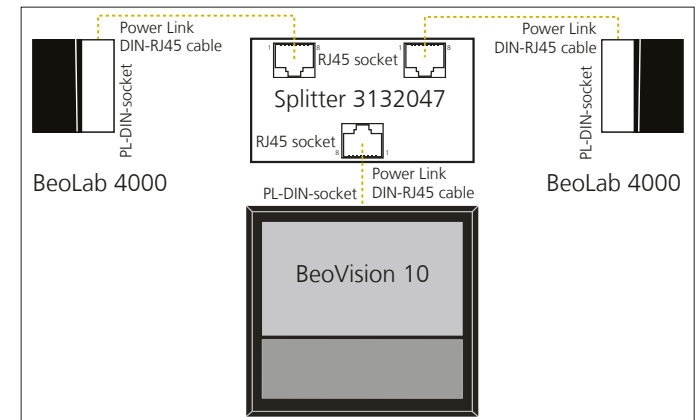

Installation examples with bill of material

Hidden installation

In the examples below, Video distribution via a switch matrix and via coax cable is not shown. External sources may be placed at each product or placed centrally using extender solutions and switch matrix solutions.

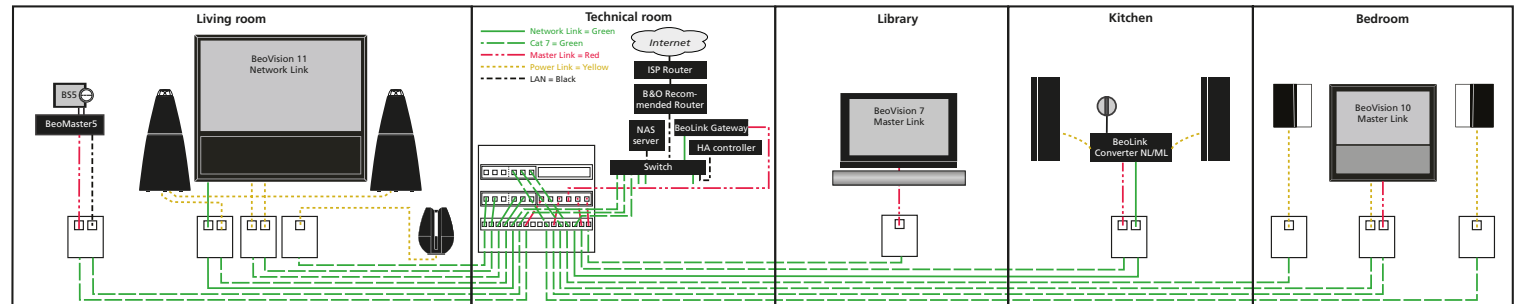

Bill of material

Part number	Pieces	Description
6250027	1 reel	Network Link Installation Cable, Cat 7/Class F
7221710	1 package	RJ45 sockets for wall outlet - straight (or optional: angled (7221711))
Various types	4	Face plates single outlet
Various types	5	Face plates double outlet
3400142	1	Cable Distribution Frame, surface mounted cabinet
3153593	1	Network Link Bracket for RJ45 sockets in cabinet
3153287	2	Network Link Bracket for Patch Module

Part number	Pieces	Description
8052352	2	Power Link Patch Module
8052351	1	Master Link Patch Module
Various lengths	25	Network Link Product Cables
Various lengths	4	Power Link Product Cable, RJ45 to RJ45
Various lengths	5	Power Link Product Cable, DIN to RJ45
Various lengths	1	Power Link Product Cable, DIN to DIN
Various lengths	5	Master Link Cable - ML to RJ45
8009947	4	Master Link socket - wall outlet

Visible installation

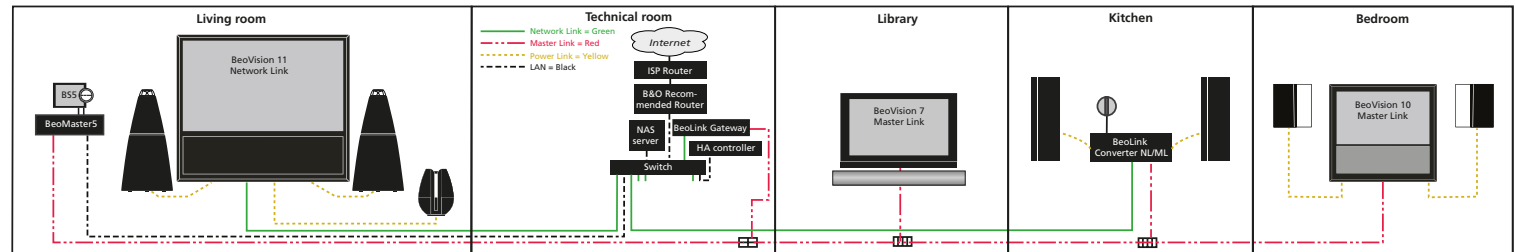

Bill of material

Part number	Pieces	Description
Various lengths	3	Network Link Product Cable
Various lengths	2	Power Link Product Cable, RJ45 to RJ45
Various lengths	3	Power Link Product Cable, DIN to RJ45
Various lengths	2	Power Link Product Cable, DIN to DIN
Various lengths	1	Master Link Cable - ML to ML

Part number	Pieces	Description
Various lengths	3	Master Link Cable - ML to RJ45
Various lengths	3	Master Link Cable - ML to RJ45/ML (plug cut off)
3375189	1	Master Link Junction Box
3634051	2	Master Link Distributor

IR-receiver installation

The incorporation kit for the IR-receiver is used for invisible installations.

Incorporation kit - solid wall

Mounting box for IR-eye in brick wall

Consists of a flush-fit socket, a spacer, a plastic cover (for covering the socket during fitting) and a decorative ring.

Ordering details see [page 131](#).

- Mount the spacer on the flush-fit-socket using the screws supplied.
- Make a hole in the wall that fits to the flush-fit-socket with spacer.
- Run the cable through flush-fit-socket, and place this in the hole flush with wall surface, and add the plastic cover while fixing with cement and let dry.
- Remove plastic cover and the screws holding the spacer.
- Install the decorative ring using the screws.
- Run cable through the centre hole of the rear plate of the IR-receiver.
- Connect wire as shown [page 119](#) though [page 124](#) (Note: Select appropriate IR-receiver).
- Install the rear plate of the IR-receiver.
- Push IR-receiver into place in the decorative ring

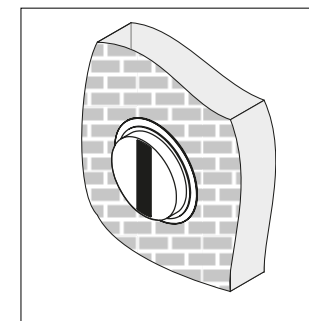
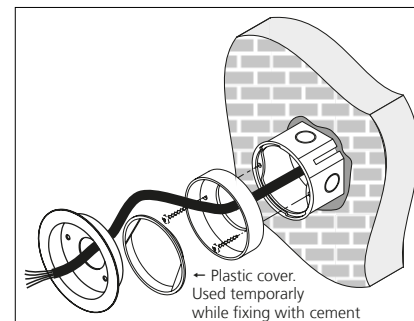

Incorporation kit - partition wall

Mounting box for IR-receiver in partition wall

Consists of two mounts and one decorative ring.

Ordering details see [page 131](#).

- Mount the two brackets on the decorative ring. The direction of the brackets depends on the thickness of the wall.
- Make a hole in the wall that the decoration ring will fit into (70 mm / 2.76").
- Run the cable through the decoration ring. Place the decoration ring in the wall.
- Turn out the two "arms". Use a small screwdriver if necessary. Turn the arm by means of the "track", and fasten the decoration ring with the two screws.
- Run the cable through the centre hole in the rear plate of the IR-receiver.
- Connect wire as shown [page 119](#) though [page 124](#) (Note: Select appropriate IR-receiver).
- Install the rear plate of the IR-receiver.
- Push IR-receiver into place in the decorative ring.

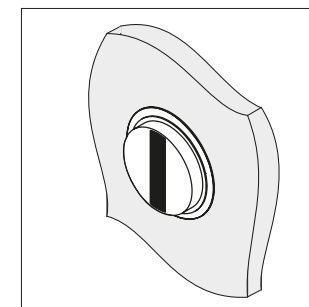
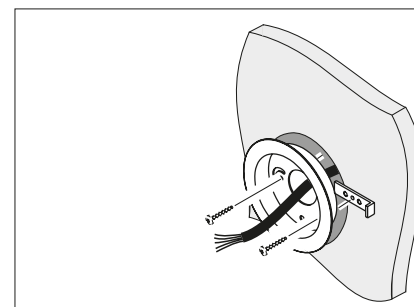

Positioning of IR-receiver

The IR-receiver must be positioned so that there is nothing preventing the reception of IR signals from a Bang & Olufsen remote control unit.

When it is decided where to position an IR-receiver, it must be considered that it is not possible to activate more than one receiver at the same time by the remote control. The illustration shows that IR-receiver 3 is correctly positioned, while receiver 1 could unintentionally be activated from room 2. Receiver 1 must instead be positioned as shown for receiver 2.

See also [page 90](#) regarding option settings.

The receiver must not be positioned in direct sunlight or direct artificial light (e.g. spotlights) or in the vicinity of products that produce electric noise (e.g. a sound attenuator or a plasma display), as such positioning could reduce the sensitivity of the receiver (= shorter remote control distance).

If the receiver is positioned outdoors, you must be aware that it will not work at temperatures above +55°C or below 0°C. If there is a risk of the temperature being outside this range, it must be possible to disconnect the IR-receiver using a switch, as it might otherwise prevent operation of the whole system.

It is often a good idea to position the receiver near a door, as this makes local operation (optional) easy when you enter or leave the room.

Note: IR-eyes are available in more models, with/without operation buttons; with/without autocontrast.

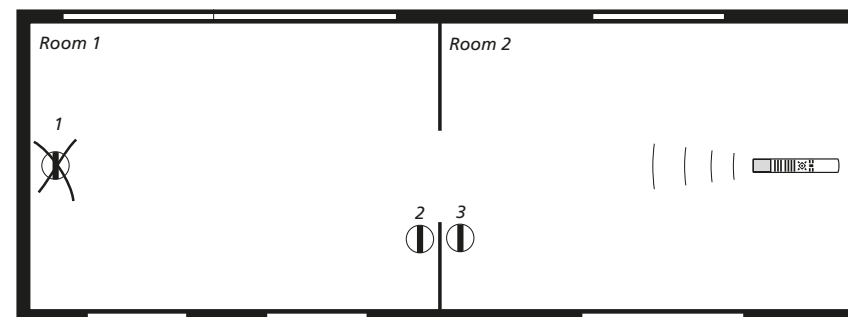

Master Link cable connections

Note: It is strongly recommended not to place such equipment in an un-isolated loft and the like (i.e. indoor environment conditions) ; see [page 82](#).

Note: wires must never be soldered to the AMP barrel terminals in the Master Link Junction Box.

Master Link Junction Box

- 1 Used for cable length adjustment, e.g. from 10 m/ 33 ft to 8.5 m/ 28 ft.
- 2 For cable colour change in visible cable installations.
For aesthetic reasons all ML cables with plugs are black. When making visible installations, it can be desirable to use grey cabling along the walls, and the transition from black to grey is easily achieved using a junction box.
- 3 Connection between products. (See figure 3 below)
There can be a maximum of 4 ML cables per Maser Link Junction Box.

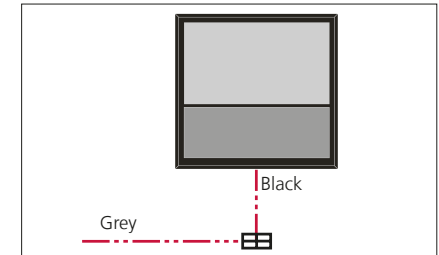
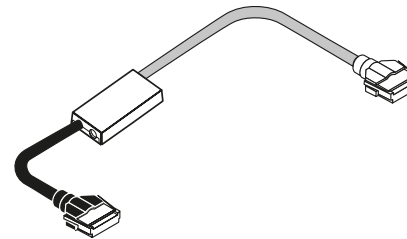

Fig. 1

Master Link Distributor

- 1 For easy connection.
 - Easier cabling
 - Easier to link more rooms on the same Master Link string
 - Eliminating errors such as loss of option settings
 - 2 All cables must apply to standard Master Link cable lengths
 - 3 Connection between products.
There can be up to six products per Master Link Distributor.
- Note: To avoid problems with subsequent deadlock, always disconnect all Master Link products in the setup from mains before plugging Master Link Cables into the Master Link Distributor.

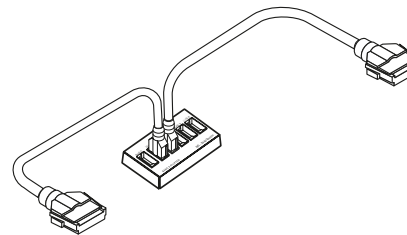

Fig. 2

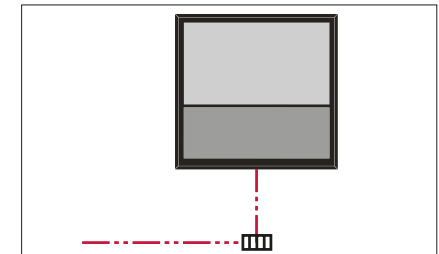
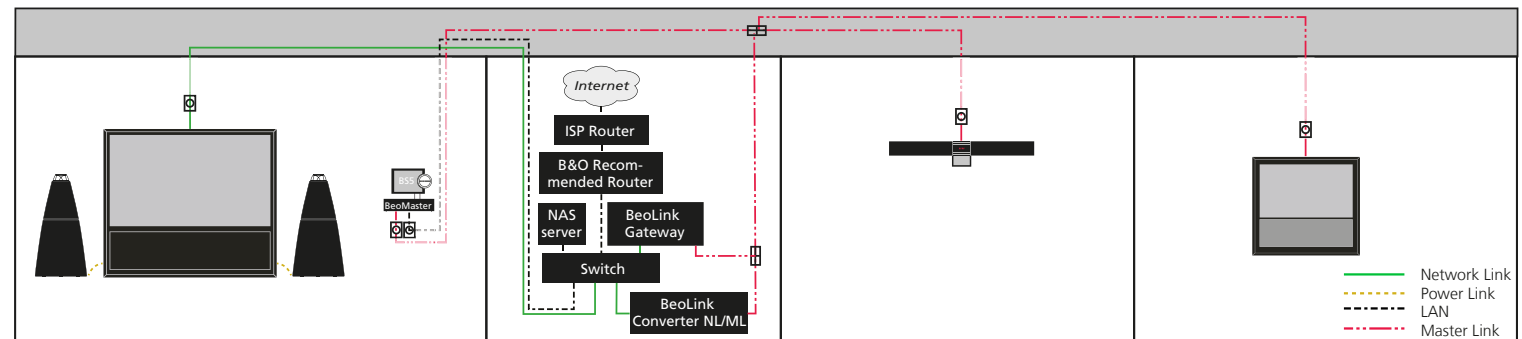

Fig. 3



Option programming

Setups

One of the conditions required for the setups to function optimally is that the products included in the setup “know” the type of system they form part of.

The actual option programming is performed by entering a particular key sequence on the remote control.

When you use Beo4, the programming sequences are as follows:

 + **LIST** simultaneously to access the setup function.

Press  until Beo4 shows **OPTION?** in the display and release both buttons.

Press  (Centre button) or **GO** to accept that you wish to perform option programming

LIST Press to change the text on the display to
V.OPT for BeoVision, or
A.OPT for BeoMaster/BeoSound, or
L.OPT for link room products

then

1 Press the correct number for the selected option, e.g. 1.

The option (number) to choose per product depends on the setup.

Option	Function	Comment
Option 0	No IR reception	
Option 1	Two IR receivers in the same room	
Option 2	One IR receiver in the room	
Option 4 (Master Link products)	Is used in a (Main) room with two Audio or two TV products. One of the Master Link products must be in option 1/2 (a Master product) and the extra Master Link product must then be in Option 4; this is for ensuring the IR control, and the Master Link product must behave as a Link product.	Used with Master Link products
Option 4 (Network Link products)	Is used in a room with two Audio or two TV products. One of the Network Link products must be in option 1/2 and the extra Network Link product must then be in Option 4; this is for ensuring the IR control	Used with Network Link products
Option 5	Two IR receivers in the same link room (1 audio product and 1 video product)	Not used with Network Link
Option 6	One IR receiver in the link room	Not used with Network Link

Most of the main room products are delivered with the correct option setting from the factory and are therefore “ready for use”. Link room products generally have to be option programmed, depending on the setup they are used in.

Note: If the option programming is not performed correctly, there will be errors in operation.

Special setups

Option 4 used in [page 10](#) can also be used if there are no walls separating a two rooms, and the product positioning in these rooms means that operation in one of the rooms leads to operation of products in another room.

By setting the link room products to option 4, allow the rooms to be used independently of one another, as a link room product set to option 4 only receives information from the remote control if the link key is activated.

See [page 92](#), about setting up Beo4 for a product set to option 4.

All link room products and link room kits using the Master Link connection can be used in this type of setup – except of BeoLink Video that is not dealt with in this handbook.

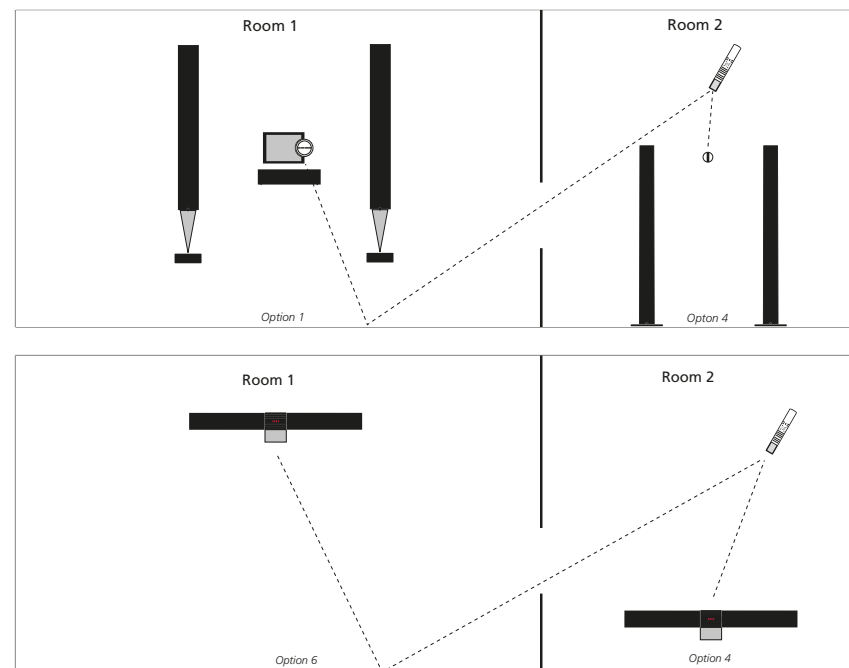

Beo4 in constant Link mode

A separate Beo4 remote control can be set in link mode to handle a specific product. This is used e.g. in where 2 TVs are placed close to each other that they can receive codes at the same time from the same remote control. The products can be separate from each other control wise by setting one of the products in Option 4. If a dedicated Beo4 is not set in constant link mode the TV that is set in Option 4 can only be controlled by first pressing **LINK** in front of all commands.

To make handling easier the Beo4 used with a link product set in Option 4 can be set in permanent Link mode; by implementing the following steps:

- Press  + **LIST** (simultaneously).
- Press the >> button until the display shows **CONFIG**.
- Press the following sequence: **2** **0** **0** **2**
The display will then show: **LINK ON**.
- Press **EXIT**.

Follow the same step sequence to put Beo4 in mode **LINK OFF**.

Note: A Beo4 remote control is only able to control products set in Option 4.

Tools

Note: Observe to select the correct instruction related to connectors and cable type; see [page 141](#) and [page 144](#) and Cat cable - colour coding of wires [page 169](#).

Crimp tool for RJ45 plug (Cat cable)

Remember to keep the tools in a good state of repair
 See "Assembly of RJ45 plug for Cat 7 Network Link Product Cable" [page 144](#).
 See Cat cable - colour coding of wires [page 169](#).

Part No.	Description	pcs. per package
3624009	Crimp tool for RJ45 plug	1



Crimp tool for RJ45 socket (jacket) - wall outlet

See "Assembly of RJ45 connector (socket/jacket) - for wall outlet - Network Link Ins" for Network Link Product Cable [page 144](#).

Part No.	Description	pcs. per package
3624008	Crimp tool for RJ45 socket (jacket) wall outlet	1



Master Link Crimp tool

Professional tool for fitting Master Link plug on Master Link cable.

[ML plugs are ordered separately.]

See "Assembly of Master Link plug for Master Link Cable" [page 147](#).

Part No.	Description	pcs. per package
3624002	Crimp tool for Master Link plug	1
3624040	Set of pliers (1)	1
3624042	Set of Pliers (2)	1
3624041	Crimp Head (3)	1
3624043	Stripping tool (4)	1



Test tools

Simple Ethernet cable tester

Simple tester used to check if there are short/open circuit or cross wiring.
 Such testers can be purchased in shops or via sales portals on the Internet.
 Observe to buy a tester that test the braided shield connection and of course the 8 wires.

Advanced Ethernet cable tester

The tester can be purchased including a number of accessories as e.g.: a CD with user guide and PC software for Fluke CableIQ, CableIQ Remote ID locators (package of 6) etc.

Example: Fluke Advanced Ethernet Tester.
 Used for advanced validation of installation.
 To be ordered via local Fluke dealer



HDMI tester

The kit consists of a 7" Portable Testing Monitor, a Portable HDMI Signal Generator, an HDMI Recorder and Hot Plug Emulator and a Portable Battery for up to 4 hours of operation.

Example: Atlona KIT-PROHD3.
 Used for advanced validation of installation.
 To be ordered as usual for Atlona products.



Part No.	Description	pcs. per package
8780331	EU, N, CH Atlona KIT-PROHD3	1

ML/PL cable tester

Professional tool for troubleshooting ML/PL installations.
Circuit tester for testing connections/cables and sockets.

The LED tester consists of two boxes and two Master Link cables; see illustration.

- The main box connects to the Master Link system. When turned On, the main box sends an electric pulse through each individual core in the Master Link cable.
- The LED box can then be connected to the remaining Master Link connections one by one. A range of LEDs will light up as the main box sends the pulses through the individual cores. By this it is possible to see if there is an end -to-end connection in all cores and thus locate the defective link (e.g. junction box or wall socket). If an LED is weakly illuminated it means that there is a poor connection. There is also an output and input for testing Power Link cables.

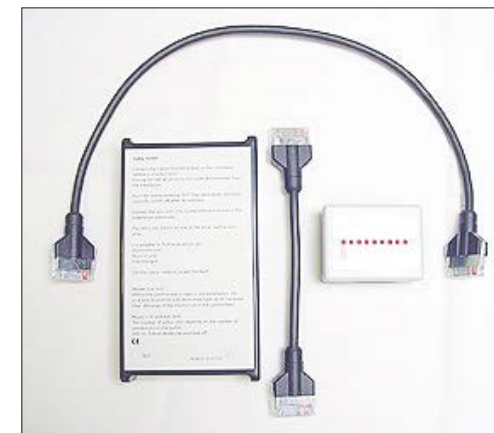

Part No.	Description	pcs. per package
8053404	ML/PL cable tester	1

User instruction

The illustration shows an example of a typical Master Link system connection.

- Disconnect all products before starting the test, as it would otherwise be impossible to circuit test the cables due to short circuits in the products.
- Connect the main box e.g. to the Master Link cable in the main room.
- Connect the LED box to all Master Link connections - one by one - until the junction box causing the problem (in this example there are only junction boxes) is located. The extra Master Link cables supplied can be used to replace the Product Cable, if that a cable between a product and a wall socket is suspected to be faulty.

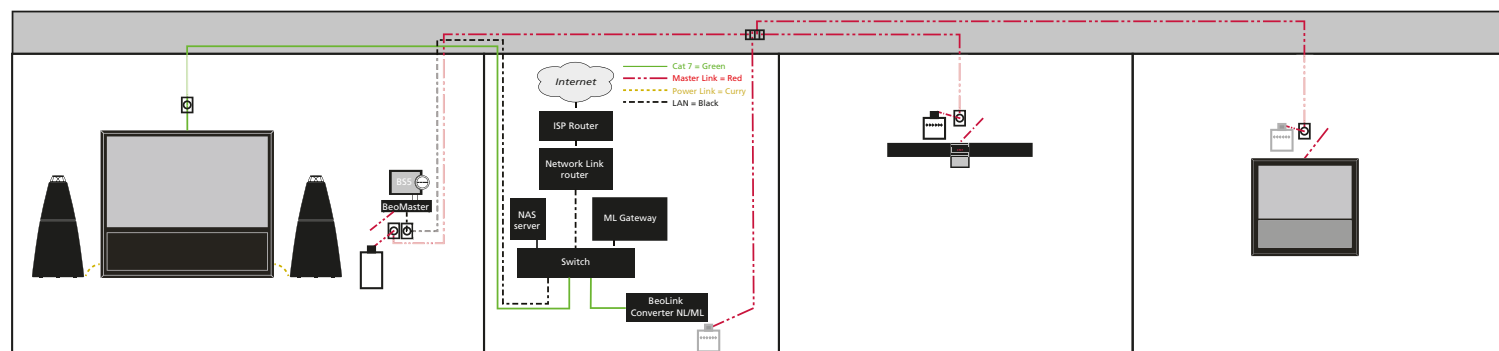

Master Link cables

Note: It is allowed to install Master Link cable outdoor. In such case it must be protected against sunlight/UV light; see [page 76](#).

Master Link Cable - wiring

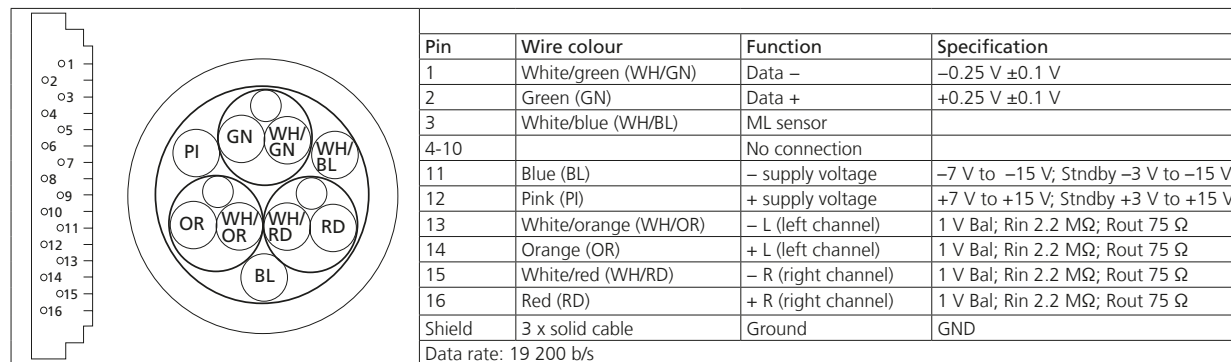

Master Link Cable - ML to ML

Used for connecting two products or a wall socket and a product.
 Ø 6.5 mm / 0.26"

Part No.	Length	Connectors	Colour
6270118	3 m / 10 ft	ML - wires	Black
6270120	0.5 m / 1.6 ft	ML - ML	Black
6270122	1.5 m / 5 ft	ML - ML	Black
6270139	3 m / 10 ft	ML - ML	Black
6270140	5 m / 16 ft	ML - ML	Black
6270141	10 m / 33 ft	ML - ML	Black
6270142	20 m / 66 ft	ML - ML	Black

Part No.	Length	Connectors	Colour
6270047	3 m / 10 ft	ML - wires	White
6270048	0.5 m / 1.6 ft	ML - ML	White
6270049	1.5 m / 5 ft	ML - ML	White
6270050	3 m / 10 ft	ML - ML	White
6270052	5 m / 16 ft	ML - ML	White
6270056	10 m / 33 ft	ML - ML	White
6270059	20 m / 66 ft	ML - ML	White

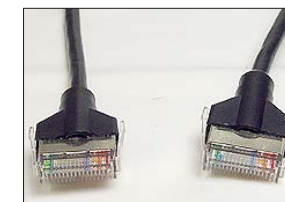

The below cables are CL2 rated

Part No.	Length	Connectors	Colour
6270662	3 m / 10 ft	ML - wires	Black
6270712	0.5 m / 2 ft	ML - ML	Black
6270713	1.5 m / 5 ft	ML - ML	Black
6270661	3 m / 10 ft	ML - ML	Black
6270714	5 m / 16 ft	ML - ML	Black
6270663	10 m / 33 ft	ML - ML	Black
6270665	20 m / 66 ft	ML - ML	Black

Note:
 Discontinuation of black Master Link cables and plugs.
 When stock of black cables and plugs are sold out, the white versions will be offered instead.

Note:
 Discontinuation of black Master Link cables and plugs.
 When stock of black cables and plugs are sold out, the white versions will be offered instead.

Master Link Cable - ML to RJ45

Used for connecting two products or a wall socket and a product.
 Ø 6.5 mm / 0.26".

Pin	Colour	Description
1	White/Green	Data -
2	Green	Data +
3	White/Blue	ML sensor
4-10	-	-
11	Blue	- supply voltage
12	Pink	+ supply voltage
13	White/Orange	- L channel
14	Orange	+ L channel
15	White/Red	- R channel
16	Red	+ R channel
Shield	3 x solid cable	GND

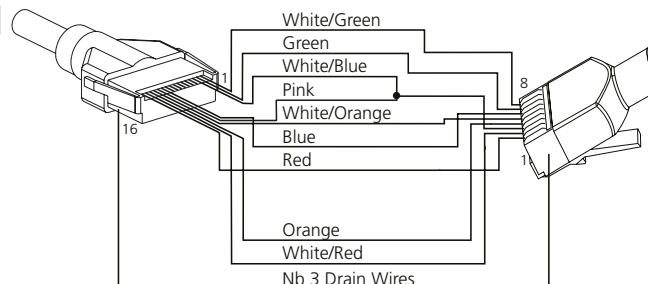

Pin	Colour	Description
1	Red	+ R channel
2	White/Red	- R channel
3	Pink+White/Blue	+ supply voltage
4	Orange	- L channel
5	White/Orange	+ L channel
6	Blue	- supply voltage
7	Green	Data +
8	White/Green	Data -
Shield	3 x solid cable	GND

Master Link Cable - ML to RJ45

Note:
 Discontinuation of black Master Link cables and plugs.
 When stock of black cables and plugs are sold out, the white versions will be offered instead.

Part No.	Length	Connectors	Colour
6271218	0.3 m / 1 ft	ML - RJ45	Black
6270006	1.5 m / 5 ft	ML - RJ45	Black
6270011	3 m / 10 ft	ML - RJ45	Black
6270002	5 m / 16 ft	ML - RJ45	Black
6270012	10 m / 33 ft	ML - RJ45	Black

Part No.	Length	Connectors	Colour
	-	-	-
6270013	1.5 m / 5 ft	ML - RJ45	White
6270014	3 m / 10 ft	ML - RJ45	White
6270015	5 m / 16 ft	ML - RJ45	White
6270016	10 m / 33 ft	ML - RJ45	White



Master Link Cable in cable reels - for installation and self mounting

Master Link cable in metre lengths. Used for connecting wall sockets.
 Ø 6.5 mm / 0.26".

See "Assembly of Master Link plug for Master Link Cable" [page 147](#).

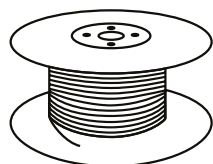

Part No.	Length	Connectors	Colour
6250013	300 m / 984 ft	-	Grey
6250004	100 m / 328 ft	-	Black
6250005	100 m / 328 ft	-	White

Note:
 Discontinuation of black Master Link cables and plugs.
 When stock of black cables and plugs are sold out, the white versions will be offered instead.

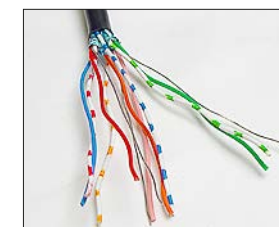

Network Link cables

All cables and instructions regarding Network Link cable are according to the TIA/EIA-568B cable standard; see [page 169](#).

Network Link Product Cable with plugs, Ø 6.0 mm / 0.24", S/FTP, Cat 7/Class F, 8 wires + braided shield

Network Link Product Cable, also used as patch cables in Network Link cabinet.

Package size: 1 piece

Pin	Colour	Description
1	White/Orange	-
2	Orange	-
3	White/Green	-
4	Blue	-
5	White/Blue	-
6	Green	-
7	White/Brown	-
8	Brown	-
Shield	Braided shield	-

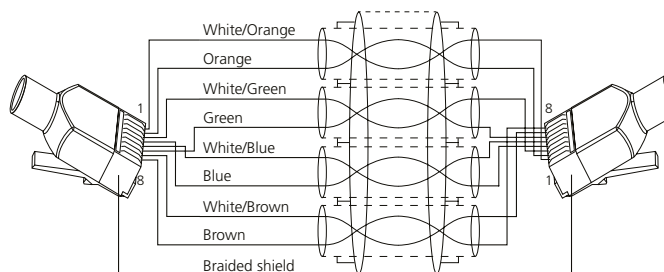

Pin	Colour	Description
1	White/Orange	-
2	Orange	-
3	White/Green	-
4	Blue	-
5	White/Blue	-
6	Green	-
7	White/Brown	-
8	Brown	-
Shield	Braided shield	-

Network Link Product Cable - RJ45 to RJ45

Part No.	Length	Connector	Colour
6271023	0.5 m / 1.6 ft	RJ45 - RJ45	White
6271024	1.5 m / 5 ft	RJ45 - RJ45	White
6271025	3 m / 10 ft	RJ45 - RJ45	White
6271026	5 m / 16 ft	RJ45 - RJ45	White
6271027	10 m / 32 ft	RJ45 - RJ45	White
6271028	20 m / 64 ft	RJ45 - RJ45	White



Network Link Installation Cable in cable reels - for self mounting, Ø 8.0 mm / 0.31", S/FTP, Cat 7/Class F, 8 wires + braided shield - solid wires AWG23

Cable is used for in-wall installation. See instruction for mounting sockets and plugs [page 141](#). May be used as LAN cable.

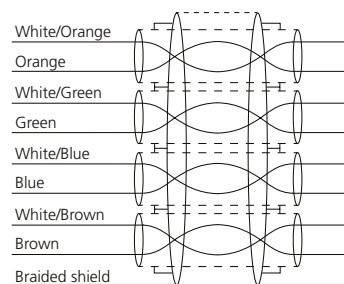
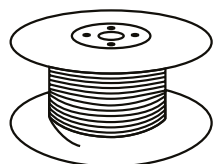

Part No.	Length	Connector	Colour
6250027	500 m / 1640 ft	-	White meter markings



Network Link Product Cable in cable reels - for self mounting, Ø 6.0 mm / 0.24", S/FTP, Cat 7/Class F, 8 wires + braided shield - strained wires AWG26

Cable is used as product cables, individually adapted in length different from product cables in standard length.

In exceptional cases the Network Link Product Cable may be used for in-wall installation although this is not recommended by Bang & Olufsen.

The Network Link Installation Cable (see [page 99](#)) may be seen as more future proof; see explanation [page 167](#) and [page 168](#).

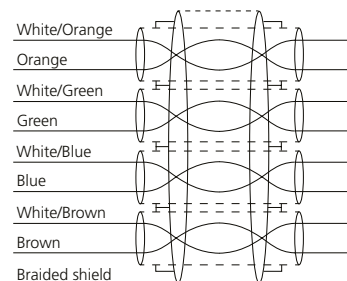
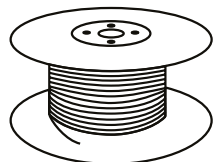

See instruction for mounting RJ45 plugs [page 144](#).

May be used as LAN cable. See instruction for mounting sockets and plugs.

Part No.	Length	Connector	Colour
6250028	300 m / 984 ft	-	White
6250033	300 m / 984 ft	-	Black

Network Link Plenum Cable in cable reels - for self mounting, Ø 6.55 mm / 0.26", S/FTP, Cat 6/Class E, 8 wires + braided shield

Cable is CL2P rated for use in special areas where high demands regarding fire codes make it necessary.

See instruction for mounting RJ45 plugs [page 144](#).

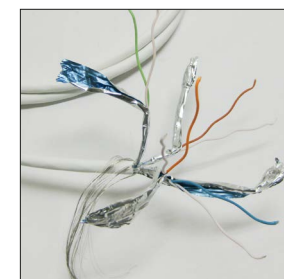
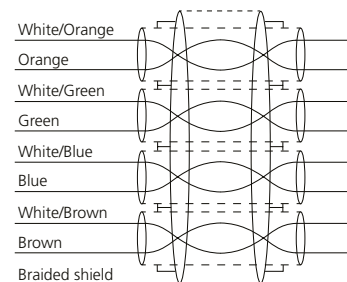
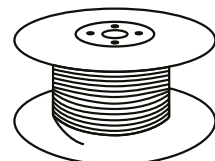

Part No.	Length	Connector	Colour
6250030	305 m / 1000 ft	-	White meter markings

Power Link cables

Power Link cable - general information

Power Link cable exists in many variants. Three variants can be ordered at present:

- The Ø 5.0 mm / 0.2" cable (with 6 wires, of which 2 pairs are foiled and the entire cable has a braided shield),. Used with all current loudspeakers and also in lengths over 10 m / 33 ft.

- The Ø 3.5 mm / 0.14" cable (with 6 wires, of which 2 pairs and 1 single wire are foiled), Used with BeoLab 3000, BeoLab 4500, BeoLab 5000, Penta MK II/III, ML/MCL Converter and BeoLink Passive used as amplifier (see [page 16](#)) . These loudspeakers need the Data wire pin 6, and pin 1 is necessary for power On/Off and pin 8 is used to detect overload. Note: Ø 3.5 mm / 0.14" cables with RJ45 plug has pin 3 and 7 short circuit.

- The Ø 2.5 mm / 0.1" cable (with 4 wires, of which 1 pair is foiled) and marked with ▼ indicating MKIII. Used with BeoLab 2, BeoLab 3, BeoLab 4, BeoLab 7 series, BeoLab 9, BeoLab 10, BeoLab 11, BeoLab 12, BeoLab 14, BeoLab 17, BeoLab 18, BeoLab 19, BeoLab 20, BeoLab 4000 MK II, BeoLab 6002, BeoLab 8002 (i.e. loudspeakers that are not power supplied using switch mode technology). Note: cables should not be used in lengths exceeding 10 m / 3 ft due to sensitivity to noise.

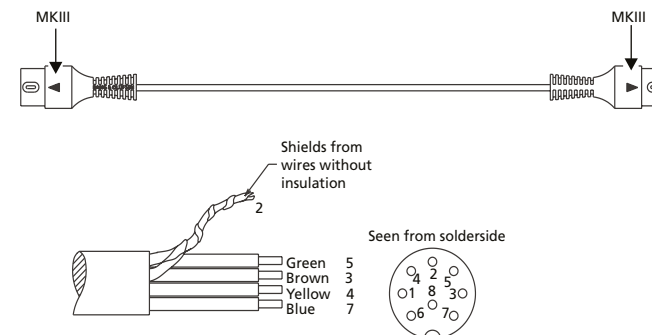

RJ45 plugs - Ø 2.5 mm PL cable

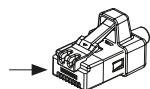

Note:

When the RJ45 plug is used with the RJ45 wall outlet socket, see [page 129](#), either use Ø 2.5 mm PL cable marked with a black stroke on the front of the plug (see illustration) and also marked on the box label as "new" or use Ø 5.0 mm PL cable.

Obsolete Power Link cables

Note: Other Power Link cables than the above mentioned are obsolete, although they of course may be used in former installations. In certain cases the obsolete cables do not fulfil the needed requirements when used with newer products, and must consequently be replaced with newer cables.

Power Link Product Cable with plugs, Ø 5.0 mm / 0.2", S/FTP, 6 wires + braided shield

These cables include the wire for display data - double shielded - twisted pair. Based on the cable type: white 6250031.

Package size: 1 piece

Power Link - Product Cable Ø 5.0 mm - DIN to DIN

Pin	Colour	Description
1	-	-
2	White/Green White/Brown	Signal GND
3	Brown	Audio L out
4	Yellow	Speaker on/off
5	Green	Audio R out
6	White	Data
7	Braided shield	Data GND
8	-	-

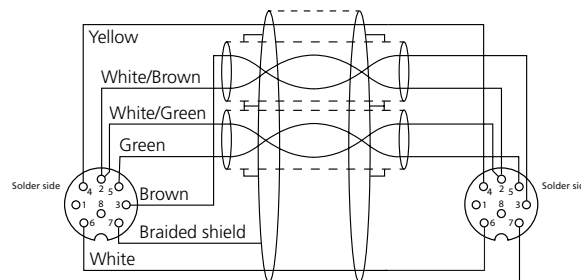

Pin	Colour	Description
1	-	-
2	White/Green White/Brown	Signal GND
3	Brown	Audio L out
4	Yellow	Speaker on/off
5	Green	Audio R out
6	White	Data
7	Braided shield	Data GND
8	-	-

Part No.	Length	Connector	Colour
6270930	2.5 m / 8 ft	DIN - DIN	Black
6270931	5 m / 16 ft	DIN - DIN	Black
6270932	10 m / 33 ft	DIN - DIN	Black
6270933	20 m / 66 ft	DIN - DIN	Black
6270934	50 m / 164 ft	DIN - DIN	Black

Part No.	Length	Connector	Colour
6270935	2.5 m / 8 ft	DIN - DIN	White
6270936	5 m / 16 ft	DIN - DIN	White
6270937	10 m / 33 ft	DIN - DIN	White
6270938	20 m / 66 ft	DIN - DIN	White
6270939	50 m / 164 ft	DIN - DIN	White



Power Link - Product Cable Ø 5.0 mm / 0.2" - DIN to RJ45

Pin	Colour	Description
1	-	-
2	White/Green White/Brown	Signal GND
3	Brown	Audio L out
4	Yellow	Speaker on/off
5	Green	Audio R out
6	White	Data
7	Braided shield	Data GND
8	-	-

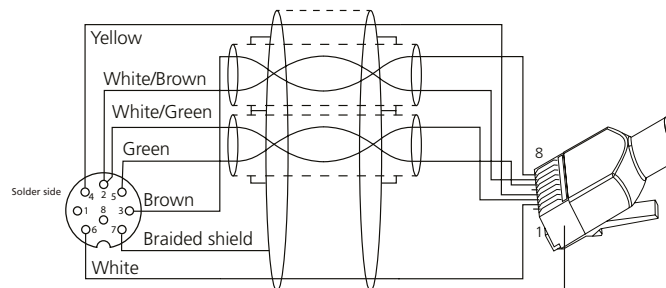

Pin	Colour	Description
1	-	-
2	White	Data
3	White/Green	Signal GND
4	Yellow	Speaker on/off
5	-	-
6	Green	Audio R out
7	White/Brown	Signal GND
8	Brown	Audio L out
Shield	Braided shield	Data GND

Part No.	Length	Connector	Colour
6270017	1.5 m / 5 ft	DIN - RJ45	Black
6270020	3 m / 10 ft	DIN - RJ45	Black
6270004	5 m / 16 ft	DIN - RJ45	Black
6270022	10 m / 33 ft	DIN - RJ45	Black

Part No.	Length	Connector	Colour
6270023	1.5 m / 5 ft	DIN - RJ45	White
6270024	3 m / 10 ft	DIN - RJ45	White
6270025	5 m / 16 ft	DIN - RJ45	White
6270026	10 m / 33 ft	DIN - RJ45	White



Power Link - Product Cable Ø 5.0 mm / 0.2" - RJ45 to RJ45

Pin	Colour	Description
1	-	-
2	White	Data
3	White/Green	Signal GND
4	Yellow	Speaker on/off
5	-	-
6	Green	Audio R out
7	White/Brown	Signal GND
8	Brown	Audio L out
Shield	Braided shield	Data GND

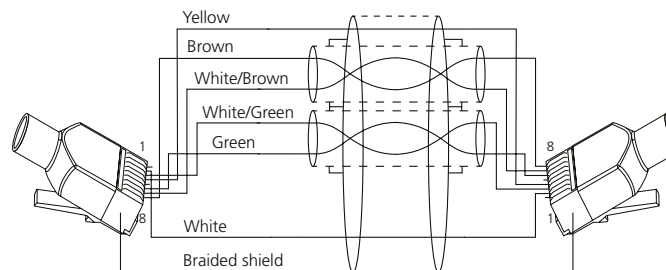

Pin	Colour	Description
1	-	-
2	White	Data
3	White/Green	Signal GND
4	Yellow	Speaker on/off
5	-	-
6	Green	Audio R out
7	White/Brown	Signal GND
8	Brown	Audio L out
Shield	Braided shield	Data GND

Part No.	Length	Connector	Colour
6271069	1.5 m / 5 ft	RJ45 – RJ45	Black
6271070	3 m / 10 ft	RJ45 – RJ45	Black
6271071	5 m / 16 ft	RJ45 – RJ45	Black
6271072	10 m / 33 ft	RJ45 – RJ45	Black

Part No.	Length	Connector	Colour
6271130	1.5 m / 5 ft	RJ45 – RJ45	White
6271131	3 m / 10 ft	RJ45 – RJ45	White
6271136	5 m / 16 ft	RJ45 – RJ45	White



Power Link Installation Cable in cable reels - for self mounting, Ø 5.0 mm / 0.2", S/FTP/UTP, 6 wires + braided shield

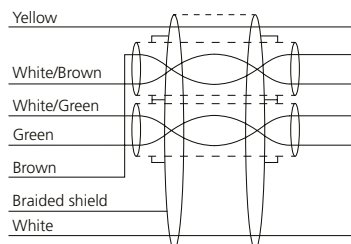
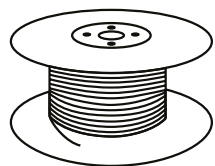

Part No.	Length	Connector	Colour
6250017	300 m / 986 ft	-	Grey with meter markings
6250031	100 m / 328 ft	-	White

Power Link Product Cable with plugs, Ø 3.5 mm / 0.14", STP/UTP, 6 wires + braided shield; (GND/shields on pin 3 and pin 7 are short-circuited when an RJ 45 is part of the cable)

These cables include the wire for power up and display data - 3 wires are single shielded. See General information [page 101](#).

Note: The cables 6271227, 6271228, 6271225, and 6271226, are needed with the ML/MCL Converter and BeoLink Passive only.

For other purposes use the Power Link Ø 5.0 mm / 0.2"; see [page 102](#).

Power Link - Product Cable Ø 3.5 mm / 0.26" - DIN to DIN

Pin	Colour	Description
1	Grey	Power up
2	Braided shield	Signal GND
3	Brown	Audio L out
4	Yellow	Speaker on/off
5	Green	Audio R out
6	White	Data
7	Braided shield	Data GND
8	Pink	Overload

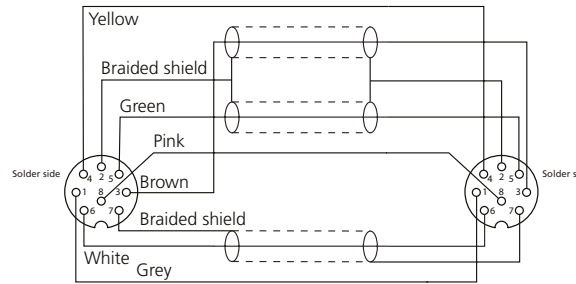

Pin	Colour	Description
1	Grey	Power up
2	Braided shield	Signal GND
3	Brown	Audio L out
4	Yellow	Speaker on/off
5	Green	Audio R out
6	White	Data
7	Braid shield	Data GND
8	Pink	Overload

Part No.	Length	Connector	Colour
6271227	5 m / 16 ft	DIN – DIN	Black
6271228	10 m / 33 ft	DIN – DIN	Black

Note.: See note above!

6270690	5 m / 16 ft	DIN – DIN	Black	with ferrite: for BeoLab 5
---------	-------------	-----------	-------	----------------------------



Power Link - Product Cable Ø 3.5 mm / 0.26" - DIN to RJ45

Pin	Colour	Description
1	Grey	Power up
2	Braided shield	Signal GND
3	Brown	Audio L out
4	Yellow	Speaker on/off
5	Green	Audio R out
6	White	Data
7	Braided shield	Data GND
8	Pink	Overload

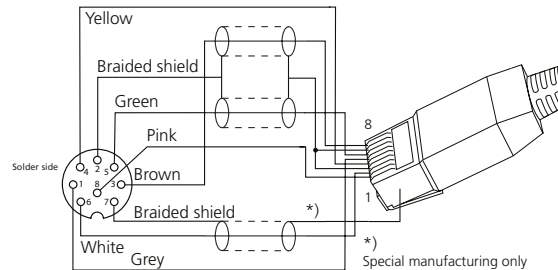

Pin	Colour	Description
1	Pink	Overload
2	White	Data
3	Braided shield	Signal GND
4	Yellow	Speaker on/off
5	Grey	Power up
6	Green	Audio R out
7	Braided shield	Signal GND
8	Brown	Audio L out
Shield		Data GND

Part No.	Length	Connector	Colour
6271225	5 m / 16 ft	DIN – RJ45	Black
6271226	10 m / 33 ft	DIN – RJ45	Black

Note.: See note above!



Power Link Product Cable with plugs, Ø 2.5 mm / 0.1", FTP, 4 wires + braided shield

These cables have no wire for data display and are marked with ▼ indicating MK III. Based on the cables: Black 6250000; White 6250001.

Power Link Product Cable Ø 2.5 mm / 0.1" - DIN to DIN

Pin	Colour	Description
1	-	-
2	Braided shield	Signal GND
3	Brown	Audio L out
4	Yellow	Speaker on/off
5	Green	Audio R out
6	-	-
7	Blue	Data GND
8	-	-

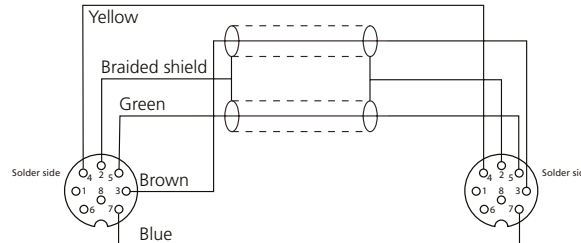

Pin	Colour	Description
1	-	-
2	Braided shield	Signal GND
3	Brown	Audio L out
4	Yellow	Speaker on/off
5	Green	Audio R out
6	-	-
7	Blue	Data GND
8	-	-

Part No.	Length	Connector	Colour
6270077	0.5 m / 1.6 ft	DIN – DIN	Black
6270147	0.75 m / 2.4 ft	DIN – DIN	Black
6270078	2.5 m / 8 ft	DIN – DIN	Black
6270079	5 m / 16 ft	DIN – DIN	Black
6270080	10 m / 33 ft	DIN – DIN	Black
6270081*	20 m / 66 ft	DIN - DIN	Black

Part No.	Length	Connector	Colour
-			
6270082	2.5 m / 8 ft	DIN – DIN	White
6270083	5 m / 16 ft	DIN – DIN	White
6270084	10 m / 33 ft	DIN – DIN	White
6270085*	20 m / 66 ft	DIN - DIN	White



* Obsolete from 2010

Power Link Product Cable Ø 2.5 mm / 0.1" - DIN to RJ45

Note:
When the RJ45 plug is used with the RJ45 wall outlet socket, see [page 129](#), either use Ø 2.5 mm PL cable marked with at black stroke on the front of the plug or use Ø 5.0 mm PL cable.

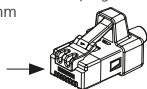

Pin	Colour	Description
1	-	-
2	Braided shield	Signal GND
3	Brown	Audio L out
4	Yellow	Speaker on/off
5	Green	Audio R out
6	-	-
7	Blue	Data GND
8	-	-

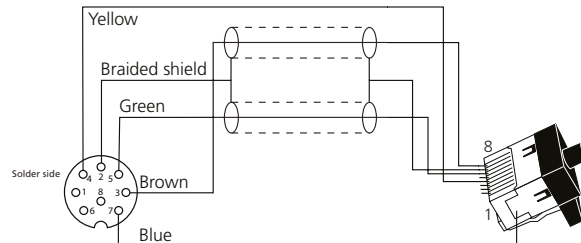

Pin	Colour	Description
1	-	-
2	-	-
3	-	-
4	Yellow	Speaker on/off
5	-	-
6	Green	Audio R out
7	Braided shield/ Green + Brown	Signal GND
8	Brown	Audio L out
Shield	Blue	Data GND

Part No.	Length	Connector	Colour
6271211	0.5 m / 1.6 ft	DIN – RJ45	Black
6271073	1.5 m / 5 ft	DIN – RJ45	Black
6271076	3 m / 10 ft	DIN – RJ45	Black
6271077	5 m / 16 ft	DIN – RJ45	Black
6271080	10 m / 33 ft	DIN – RJ45	Black

Part No.	Length	Connector	Colour
-			
6271105	1.5 m / 8 ft	DIN – RJ45	White
6271106	3 m / 10 ft	DIN – RJ45	White
6271107	5 m / 16 ft	DIN – RJ45	White
6271116	10 m / 33 ft	DIN – RJ45	White

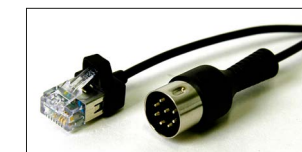

Power Link - Product Cable Ø 2.5 mm / 0.1" - RJ45 to RJ45

Note:
When the RJ45 plug is used with the RJ45 wall outlet socket, see page 129, either use Ø 2.5 mm PL cable marked with a black stroke on the front of the plug or use Ø 5.0 mm PL cable.

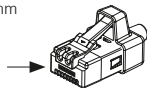

Pin	Colour	Description
1	-	-
2	-	-
3	-	-
4	Yellow	Speaker on/off
5	-	-
6	Green	Audio R out
7	Braided shield/ Green + Brown	Signal GND
8	Brown	Audio L out
Shield	Blue	Data GND

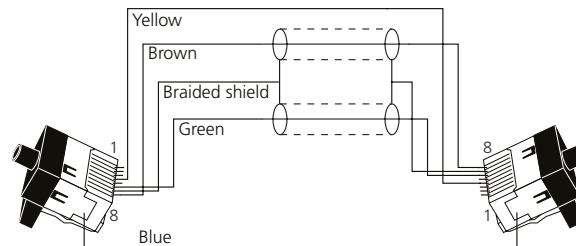

Pin	Colour	Description
1	-	-
2	-	-
3	-	-
4	Yellow	Speaker on/off
5	-	-
6	Green	Audio R out
7	Braided shield/ Green + Brown	Signal GND
8	Brown	Audio L out
Shield	Blue	Data GND

Part No.	Length	Connector	Colour
6278731	0.35 m / 1 ft	RJ45 – RJ45	Black
6271212	0.5 m / 1.6 ft	RJ45 – RJ45	Black
6271065	1.5 m / 5 ft	RJ45 – RJ45	Black
6271066	3 m / 10 ft	RJ45 – RJ45	Black
6271272	4 m / 13 ft	RJ45 – RJ45	Black
6271067	5 m / 16 ft	RJ45 – RJ45	Black
6271068	10 m / 33 ft	RJ45 – RJ45	Black

Part No.	Length	Connector	Colour
6271117	1.5 m / 5 ft	RJ45 – RJ45	White
6271120	3 m / 10 ft	RJ45 – RJ45	White
-	-	-	-
6271121	5 m / 16 ft	RJ45 – RJ45	White
6271122	10 m / 33 ft	RJ45 – RJ45	White

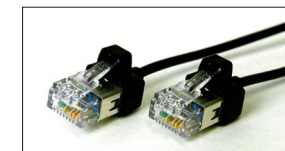

Power Link Product Cable in cable reels - for self mounting, Ø 2.5 mm / 0.1", S/FTP/UTP, 4 wires + braided shield

Used between wall outlet and product.

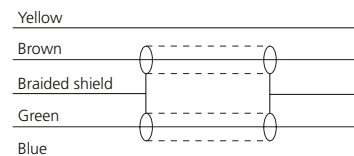
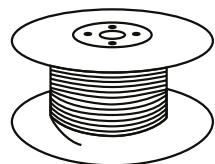

Part No.	Length	Connector	Colour
6250000	100 m/328 ft	-	Black
6250001	100 m 328 ft	-	White

Obsolete Power Link Product Cable with plugs, Ø 3.5 mm / 0.14", STP/UTP, 6 wires + braided shield; pin 3 and pin 7 are short circuit

These cables include the wire for power up and display data - 3 wires are single shielded.

DIN to DIN Power Link

Pin	Colour	Description
1	Grey	Power up
2	Braided shield	Signal GND
3	Brown	Audio L out
4	Yellow	Speaker on/off
5	Green	Audio R out
6	White	Data
7	Braided shield	Data GND
8	Pink	Overload

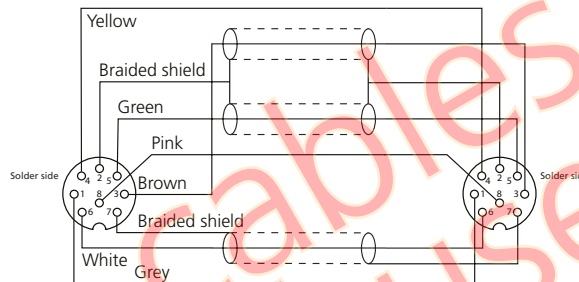

Pin	Colour	Description
1	Grey	Power up
2	Braided shield	Signal GND
3	Brown	Audio L out
4	Yellow	Speaker on/off
5	Green	Audio R out
6	White	Data
7	Braided shield	Data GND
8	Pink	Overload

Part No.	Length	Connector	Colour	Part No.	Length	Connector	Colour
6270143	2.5 m / 8 ft	DIN – DIN	Black	6270063	2.5 m / 8 ft	DIN – DIN	White
6270144	5 m / 16 ft	DIN – DIN	Black	6270064	5 m / 16 ft	DIN – DIN	White
6270145	10 m / 33 ft	DIN – DIN	Black	6270065	10 m / 33 ft	DIN – DIN	White
6270146	20 m / 66 ft	DIN – DIN	Black	6270066	20 m / 66 ft	DIN – DIN	White



DIN to RJ45 Power Link

Pin	Colour	Description
1	Grey	Power up
2	Braided shield	Signal GND
3	Brown	Audio L out
4	Yellow	Speaker on/off
5	Green	Audio R out
6	White	Data
7	Braided shield	Data GND
8	Pink	Overload

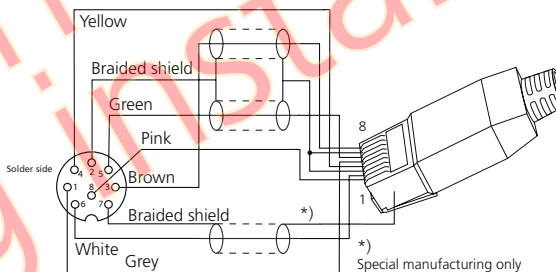

Pin	Colour	Description
1	Pink	Overload
2	White	Data
3	Braided shield	Signal GND
4	Yellow	Speaker on/off
5	Grey	Power up
6	Green	Audio R out
7	Braid shield	Data GND
8	Brown	Audio L out
Shield	Braided shield	Data GND

Part No.	Length	Connector	Colour	Part No.	Length	Connector	Colour
6270017	1.5 m / 5 ft	DIN – RJ45	Black	6270023	1.5 m / 5 ft	DIN – RJ45	White
6270020	3 m / 10 ft	DIN – RJ45	Black	6270024	3 m / 10 ft	DIN – RJ45	White
6270004	5 m / 16 ft	DIN – RJ45	Black	6270025	5 m / 16 ft	DIN – RJ45	White
6270022	10 m / 33 ft	DIN – RJ45	Black	6270026	10 m / 33 ft	DIN – RJ45	White



Note: The numbers for these obsolete DIN-RJ45 cables are re-used for newer Ø 5.0 mm cables, although these are not fully mounted. Instead use the Power Link Product Cables Ø 3.5 mm with wire for display data .

Obsolete Power Link Product Cable with plugs, Ø 5.5 mm / 0.24", S/FTP/UTP, 6 wires + braided shield

DIN to DIN Power Link

Pin	Colour	Description
1	Grey	Power up
2	Braided shield	Signal GND
3	Brown	Audio L out
4	Yellow	Speaker on/off
5	Green	Audio R out
6	White	Data
7	Braided shield	Data GND
8	Pink	Overload

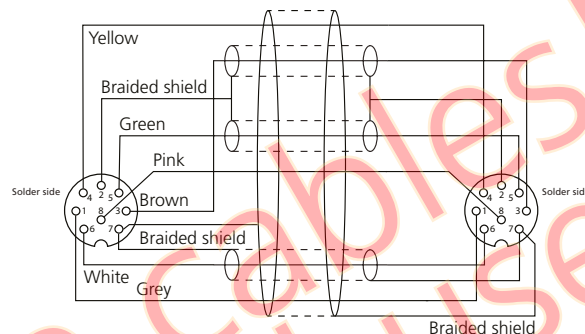

Pin	Colour	Description
1	Grey	Power up
2	Braided shield	Signal GND
3	Brown	Audio L out
4	Yellow	Speaker on/off
5	Green	Audio R out
6	White	Data
7	Braided shield	Data GND
8	Pink	Overload

Part No.	Length	Connector	Colour	Part No.	Length	Connector	Colour
6270930	2.5 m / 8 ft	DIN – DIN	Black	6270935	2.5 m / 8 ft	DIN – DIN	White
6270931	5 m / 16 ft	DIN – DIN	Black	6270936	5 m / 16 ft	DIN – DIN	White
6270932	10 m / 33 ft	DIN – DIN	Black	6270937	10 m / 33 ft	DIN – DIN	White
6270933	20 m / 66 ft	DIN – DIN	Black	6270938	20 m / 66 ft	DIN – DIN	White
6270934	50 m / 164 ft	DIN – DIN	Black	6270939	50 m / 164 ft	DIN – DIN	White



Note: The numbers for these obsolete DIN-DIN cables are re-used for newed Ø 5.0 / 0.2" mm cables, although these are not fully mounted. Instead use the Power Link Product Cables Ø 3.5 mm / 0.14" with wire for display data .

Obsolete cables! - although existing installations.

Obsolete Power Link Product Cable with plugs, Ø 2.5 mm/ 0.1", FTP/UTP, 3 wires + braided shield

These cables have no blue wire for data GND and no ▼ symbol. Used for e.g. BeoLab 4000, BeoLab 6000 and BeoLab 8000. These cables will lead to unwanted noise if used with loudspeakers designed with switch mode technology. Instead use Power Link Product Cable Ø 2.5 mm/ 0.1" marked with ▼ indicating MK III

DIN to DIN Power Link

Pin	Colour	Description
1	-	-
2	Braided shield	Signal GND
3	Brown	Audio L out
4	Yellow	Speaker on/off
5	Green	Audio R out
6	-	-
7	-	-
8	-	-

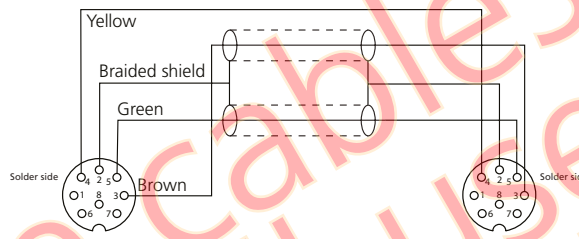

Pin	Colour	Description
1	-	-
2	Braided shield	Signal GND
3	Brown	Audio L out
4	Yellow	Speaker on/off
5	Green	Audio R out
6	-	-
7	-	-
8	-	-

Part No.	Length	Connector	Colour
6270644	2.5 m / 8 ft	DIN – DIN	Black
6270645	5 m / 16 ft	DIN – DIN	Black
6270646	10 m / 33 ft	DIN – DIN	Black
6270647	20 m / 66 ft	DIN – DIN	Black



Obsolete cables still used in existing installations!

Power Link Splitters

Power Link Splitter Cable

Power Link plug DIN (male) that is split into two Power Link sockets DIN (female).
Used for serial connection of active loudspeakers.

Pin	Colour	Description
1	Grey	Power up
2	Braided shield	Signal GND
3	Brown	Audio L out
4	Yellow	Speaker on/off
5	Green	Audio R out
6	White	Data
7	Braided shield	Data GND
8	Pink	Overload

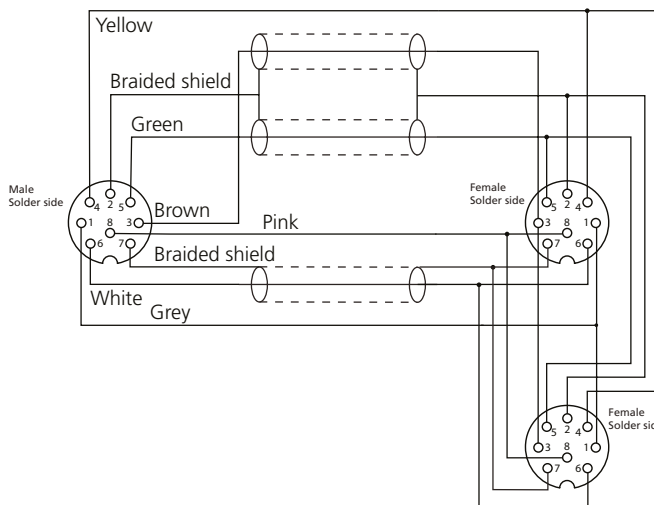

Pin	Colour	Description
1	Grey	Power up
2	Braided shield	Signal GND
3	Brown	Audio L out
4	Yellow	Speaker on/off
5	Green	Audio R out
6	White	Data
7	Braided shield	Data GND
8	Pink	Overload

Pin	Colour	Description
1	Grey	Power up
2	Braided shield	Signal GND
3	Brown	Audio L out
4	Yellow	Speaker on/off
5	Green	Audio R out
6	White	Data
7	Braided shield	Data GND
8	Pink	Overload

Part No.	Dimensions	Comments	pcs. per package
6270705 A	Ø 3.5 mm / 1.4"; 1.6 m / 5.3 ft	6 wires + braided shield DIN male to 2 x DIN female ('fully mounted') PL cable; 6 wires + braided shield 1.8 m / 6 ft - 0.2 m / 0.65 ft	1
6270706 B	Ø 3.5 mm / 1.4"; 0.2 m / 0.7 ft	6 wires + braided shield DIN male to 2 x DIN female ('fully mounted') PL cable; 6 wires + braided shield 0.24 m / 0.78 ft - 0.2 m / 0.65 ft	1



Power Link Splitter Cable - subwoofers

Power Link plug DIN (male) that is split into two Power Link sockets DIN (female).
 Modified to having R channel signal in the one DIN female socket - marked R and having the L channel signal in the other DIN female socket - marked L.
 Used for connecting two subwoofers playing R and L channel respectively.

Pin	Colour	Description
1	Grey	Power up
2	Braided shield	Signal GND
3	Brown	Audio L out
4	Yellow	Speaker on/off
5	Green	Audio R out
6	White	Data
7	Braided shield	Data GND
8	Pink	Overload

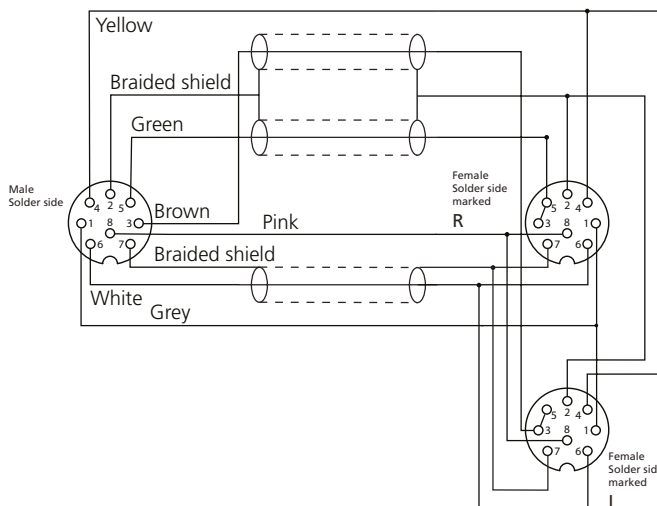

Pin	Colour	Description
1	Grey	Power up
2	Braided shield	Signal GND
3	Connected to 5	Audio R out
4	Yellow	Speaker on/off
5	Green	Audio R out
6	White	Data
7	Braided shield	Data GND
8	Pink	Overload

Pin	Colour	Description
1	Grey	Power up
2	Braided shield	Signal GND
3	Brown	Audio L out
4	Yellow	Speaker on/off
5	Green	Audio R out
6	White	Data
7	Braided shield	Data GND
8	Pink	Overload

Part No.	Dimensions	Comments	pcs. per package
6200182 A	Ø 3.5 mm / 1.4"; 1.6 m / 5.3 ft	6 wires + braided shield DIN male to DIN female L and DIN female R used for 2 subwoofers; ('fully mounted') PL cable 1.8 m / 6 ft - 0.2 m / 0.65 ft	1



Power Link Splitter - Mini Jack to 2 DIN - Ø 3.5 mm; 2.5 m / 8 ft

Mini Jack Ø 3.5 mm / 0.14" Stereo split into two DIN (Power Link) for BeoLab 3, BeoLab 9, BeoLab 4000 MK II, BeoLab 6002, BeoLab 8002

Pin	Description/Description/Colour	Use
1	Tip/Inner/Braided Shield	Audio L out
2	Ring/outer/Brown	Audio R out
3	Sleeve/Shield/Green	Shield

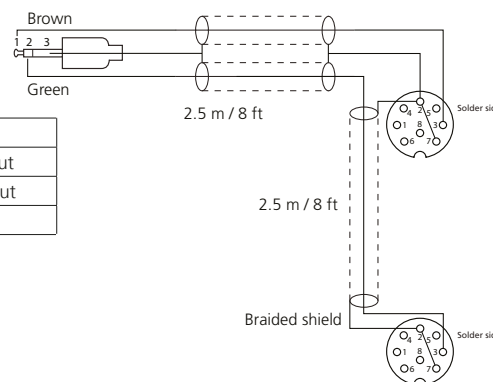

Pin	Colour	Description
1	-	-
2	Braided shield	Signal GND
3	Brown	Audio (L) out
4	-	-
5	-	-
6	-	-
7	-	Signal GND
8	-	-

Pin	Colour	Description
1	-	-
2	Braided shield	Signal GND
3	-	Audio (R) out
4	-	-
5	-	-
6	-	-
7	-	Signal GND
8	-	-

Part No.	Connectors	Dimensions	pcs. per package
6270642	1 Mini Jack Stereo to 2 x DIN	2.5 m / 8 ft	1



Power Link Splitter Box 3 x RJ45 female

Used for Power Link and Master Link.

Part No.	Connectors	pcs. per package
3132047	RJ45 to 2 x RJ45	1



Power Link Adaptors

Power Link Adaptor DIN (female) to DIN (female)

Power Link Adaptor 8 pin DIN (female) to DIN (female)

Part No.	Connectors	pcs. per package
7229075	PL 8 pin DIN to DIN	1

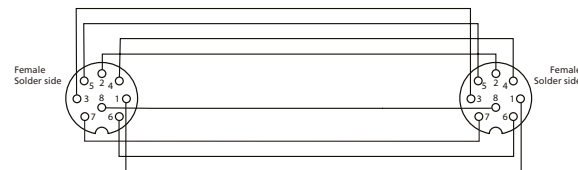

Power Link Adaptor RJ45 to DIN (female)

Used for connecting new products, with existing Power Link cable, that has DIN connector (male).

Pin	Colour	Use
1	-	
2	White/Green White/Brown	Signal GND
3	Brown	Audio L out
4	Yellow	Speaker on/off
5	Green	Audio R out
6	White	Data
7	Braided shield	Data GND
8	-	

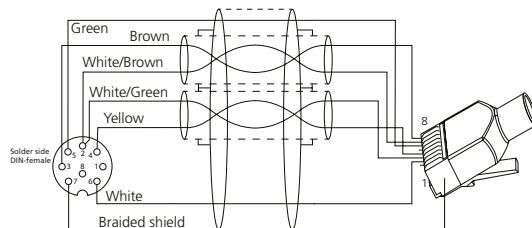

Pin	Colour	Description
1	-	-
2	White	Data
3	White/Green	Signal GND
4	Yellow	Speaker on/off
5	-	-
6	Green	Audio R out
7	White/Brown	Signal GND
8	Brown	Audio L out
Shield	Braided shield	Data GND

Part No.	Connectors	Dimensions	pcs. per package
6271237	DIN to RJ45	Ø 5 mm / 0.2"; 0.25 m / 1 ft	1



Power Link Adaptor - RCA male to DIN

Cable with RCA male to DIN (Power Link) for 3rd party pre-amplifiers.

Pin	Description/Colour	Use
1	Centre pin/Brown	Audio L/R out
2	Braided shield	Signal GND

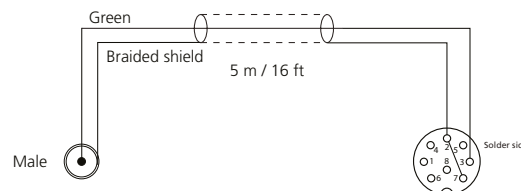

Pin	Colour	Description
1	-	-
2	Braided shield	Signal GND
3	Brown	Audio L out
4	-	-
5	-	-
6	-	-
7	-	Signal GND
8	-	-

Part No.	Connectors	Dimensions	pcs. per package
6270856	RCA male to DIN	5 m / 16 ft	1



Power Link Adaptor - RCA male to RJ45

Adapter 2 x RCA male to PL RJ45, black (Power Link) for BeoLab 12, BeoLab 1, BeoPlay S8 and other loudspeakers with RJ45 connector

Pin	Description/Colour	Use
1	Centre pin/Brown	Audio L out
2	Shield-brown+blue	Signal GND

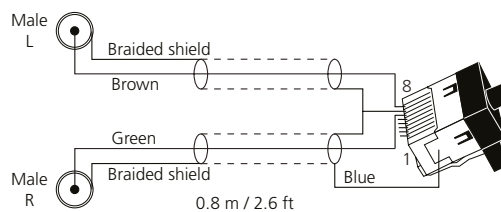

Pin	Description/Colour	Use
1	Centre pin/Green	Audio R out
2	Shield-green+blue	Signal GND

Pin	Colour	Description
1	-	-
2	-	-
3	-	-
4	-	-
5	-	-
6	Green	Audio R out
7	Braided shield	Signal GND
8	Brown	Audio L out
GND	Blue	Data GND

Part No.	Connectors	Dimensions	pcs. per package
6271216	2 x RCA female to RJ45	0.8 m / 2.6 ft	1
6271265	2 x RCA female to RJ45	2 m / 6.6 ft	1



Power Link Adaptor - RCA female to DIN

Cable with an RCA female to DIN (Power Link) for Line-in from e.g. Apple universal docking or other source product to e.g. BeoLab 3, BeoLab 9, BeoLab 4000.

Pin	Description/Colour	Use
1	Centre pin/Brown	Audio L/R out
2	Braided shield	Signal GND

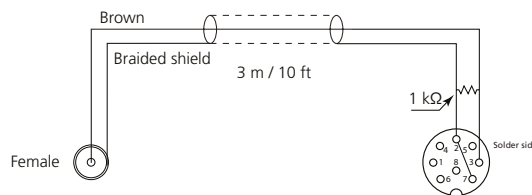

Pin	Colour	Description
1	-	-
2	Braided shield	Signal GND
3	Brown	Audio L out
4	-	-
5	-	-
6	-	-
7	-	Signal GND
8	-	-

Part No.	Connectors	Dimensions	pcs. per package
6270943	RCA female to DIN	3 m / 10 ft	2



Power Link Adaptor - Mini Jack Stereo to RJ45

Cable with a Mini Jack Stereo plug (from hand held or stationary source device) to RJ45 (to PL in Front). To be used with BeoPlay S8 and BeoLab 14 and other active speakers with RJ45 PL sockets.

Pin	Description/Colour	Use
1	Tip/White	Audio L out
2	Ring/Red	Audio R out
3	Sleeve/Braided shield	Signal GND

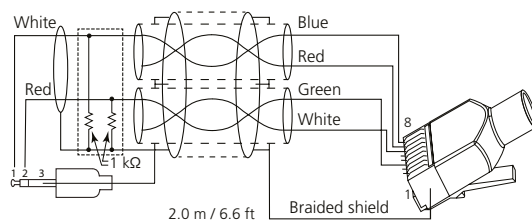

Pin	Colour	Description
1	-	-
2	-	-
3	White	Signal GND
4	-	-
5	-	-
6	Green	Audio R in
7	Red	Signal GND
8	Blue	Audio L in
Shield	Braided shield	Data GND

Part No.	Connectors	Dimensions	pcs. per package
6271285	Mini Jack Stereo to RJ45	2 m / 6.6 ft	1



Various Adaptors

Mini Jack to 2 RCA female -adaptor - Ø 3.5 mm / 0.14"; 3.0 m / 10 ft

Mini Jack Ø 3.5 mm Stereo split into two RCA female. In combination with the cable 6271216 it adapts to Power Link; see [page 114](#).

Pin	Description	Use
1	Tip/Inner	Audio L out
2	Ring/Outer	Audio R out
3	Sleeve/Shield	Braided shield

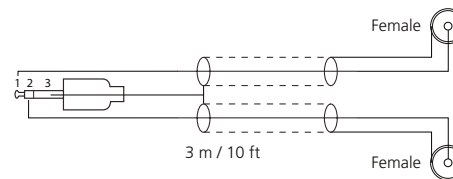

Pin	Description	Use
1	Centre pin	Audio R out
2	Braided shield	Signal GND

Pin	Description	Use
1	Centre pin	Audio L out
2	Braided shield	Signal GND

Part No.	Connectors	Dimensions	pcs. per package
6270433	1 Mini Jack Stereo to 2 x RCA female	3 m / 10 ft	1



RCA female to 7 pin DIN - adaptor

Cable with 2 RCA female to 7 pin DIN, specially made for AUX input to BeoLink Active.

Pin	Description	Use
1	Centre pin	Audio L out
2	Braided shield	Signal GND

Pin	Description	Use
1	Centre pin	Audio L out
2	Braided shield	Signal GND

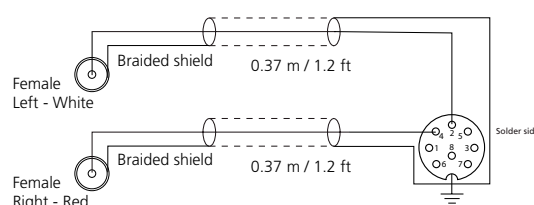

Pin	Colour	Description
1	-	-
2	-	Audio L out
3	-	-
5	-	-
5	-	Audio R out
6	-	-
7	-	-
8	-	-
Shield	Braided shield	Signal GND

Part No.	Connectors	Dimensions	pcs. per package
6271020	2xRCA female to DIN	0.37 m / 1.2 ft	1



Mini Jack Stereo to 7 pin DIN - adaptor

Cable with a Mini Jack Stereo plug (from hand held or stationary source device) to 7 pin DIN (to AUX in).

Pin	Description/Colour	Use
1	Tip/Brown	Audio L out
2	Ring/Green	Audio R out
3	Sleeve/Braided shield	Signal GND

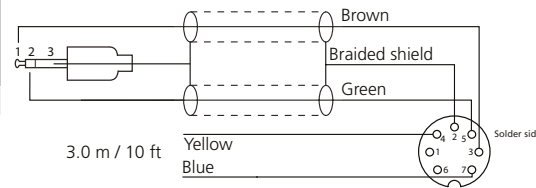

Pin	Colour	Description
1	-	-
2	Braided shield	Signal GND
3	Brown	Audio L in
4	Yellow	-
5	Green	Audio R in
6	-	-
7	Blue	-

Part No.	Connectors	Dimensions	pcs. per package
6277956	Mini Jack Stereo to 7 pin DIN	3 m / 10 ft	1



RCA female to 5 pin DIN - adaptor

Cable with 2 RCA female to 5 pin DIN, having two purposes:

- to source input signal via AUX socket to e.g. BeoSound 9000.
- to take out the volume adjusted signal from a PL socket to a 3rd party amplifier feeding passive speakers.

Pin	Description	Use
1	Centre pin	Audio L out
2	Braided shield	Signal GND

Pin	Description	Use
1	Centre pin	Audio L out
2	Braided shield	Signal GND

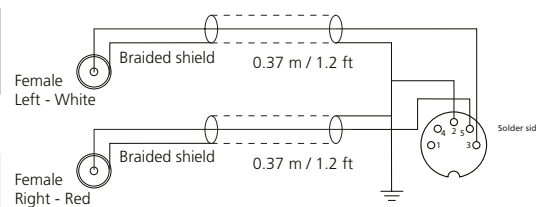

Pin	Colour	Description
1	-	-
2	-	Signal GND
3	-	Audio L out
5	-	Audio R out
6	-	-
7	-	-
8	-	-
Shield	Braided shield	Signal GND

Part No.	Connectors	Dimensions	pcs. per package
6270302	2xRCA female to 5 pin DIN	0.37 m / 1.2 ft	1



S/P-DIF / RCA / Line cables

S/P-DIF / RCA / Line cable with RCA male to RCA male, 75Ω.

Pin	Description/Colour	Use
1	Centre pin	Signal
2	Braided shield	Signal GND

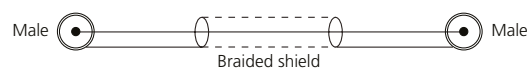

Pin	Colour	Description
1	Centre pin	Signal
2	Braided shield	Signal GND

Part No.	Connectors	Dimensions	pcs. per package
6270392	S/P-DIF / RCA / Line cable; Black RCA male to RCA male	3.1 m / 10.2 ft	1
6270775	S/P-DIF / RCA / Line cable; Black RCA male to RCA male	5 m / 16 ft	1
6270404	S/P-DIF / RCA / Line cable; White RCA male to RCA male	10 m / 33 ft	1



IR solutions

IR-receiver with control buttons

BeoLink Converter NL/ML

Includes 10 m / 33 ft of cable.

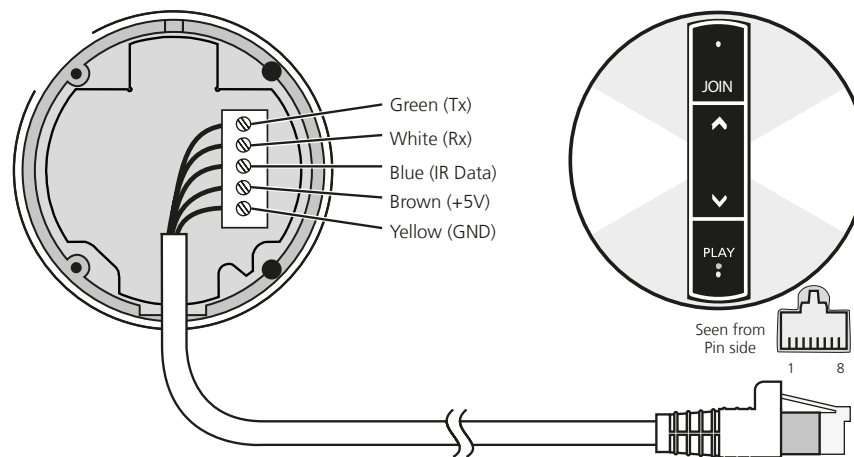

Part No.	Description	pcs. per package
8089119	IR kit incl. 10 m / 33 ft cable	1
6271239	IR cable BLC NL/ML, RJ45 to pigtail, 10 m / 33 ft, White	1
6271026 6271027 6271028 6250027	May be extended using Network Link Product Cable or Network Link Installation Cable - total length up to 100 m / 328 ft; see page 99 .	

Pin	Colour	Description
1	Brown	+5V
2	White	Rx
3	Green	Tx
4	Yellow	GND
5	-	Not used
6	-	Not used
7	Blue	IR Data
8	-	Not used

BeoLink Active, BeoLink Passive

Also used with the optional products: ML/MCL Converter, BeoLink Passive. Cable included.

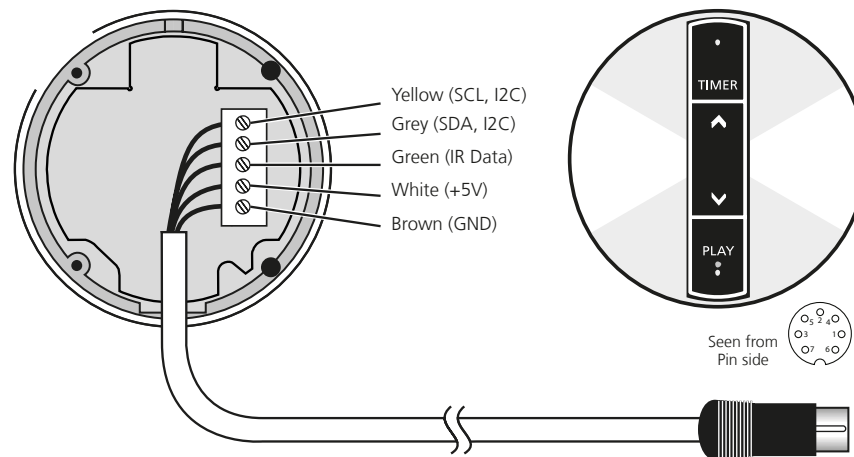

Part No.	Description	pcs. per package
3375921	IR kit incl. 5 m / 16 ft cable, EU	1
3375942	IR kit incl. 15 m / 49 ft cable, US	1

Pin	Colour	Description
1	Yellow	SCL I2C
2	Brown	GND
3	-	Not used
4	Grey	SDA, I2C
5	-	Not used
6	White	+5V
7	Green	IR Data

Low-capacity IR-receiver cable

Used for connecting an IR receiver and a BeoLink Active/Passive where more than 5 m / 16 ft cable is required.

Part No.	Description	pcs. per package
6270655	Low-capacity IR cable 5 m/16 ft, white, EU	1
6270668	Low-capacity IR cable 15 m/49 ft, white, EU	1
6270682	Low-capacity IR cable 15 m/49 ft, white, US	1



IR-eye with Autocontrast

BeoSystem 4

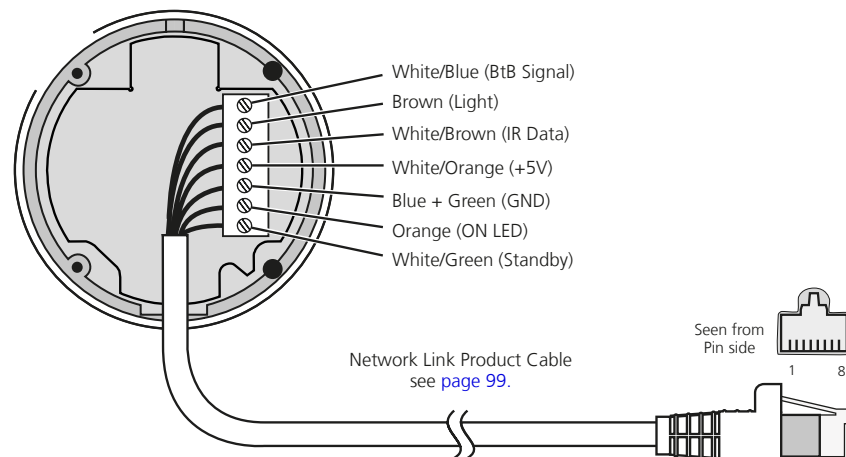

Part No.	Description	pcs. per package
8089000	IR-eye with autocontrast	1
6271026	Choose a Network Link Product Cable or make one using a	
6271027	Network Link Installation Cable	
6250027	- up to 100 m / 328 ft; see page 99	

Pin	Colour	Description
1	White/Orange	+5V
2	Orange	ON LED
3	White/Green	Standby
4	Blue	GND
5	White/Blue	BtB Signal
6	Green	GND
7	White/Brown	IR Data
8	Brown	Light
Shield	Braided shield	Data GND

BeoSystem 3

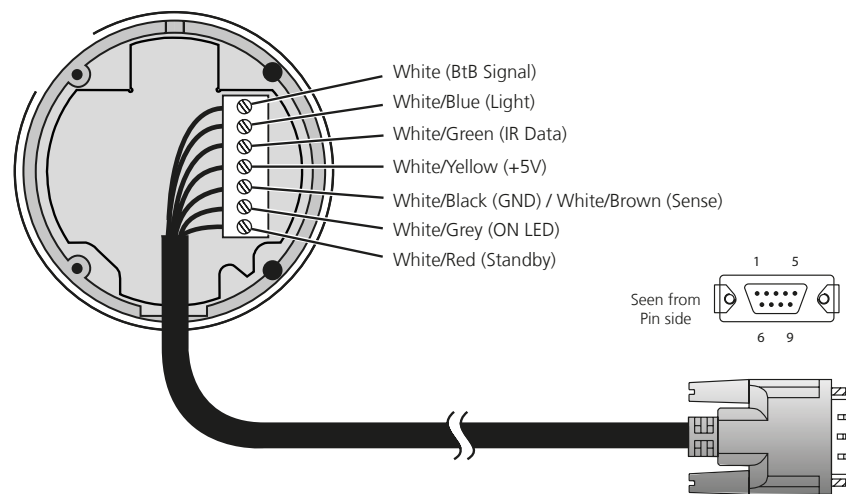

Part No.	Description	pcs. per package
8089000	IR-eye with autocontrast	1
6270624	Cable for IR-eye with autocontrast for older BeoSystem 3, 15 m / 50 ft, black, 7 pin DIN	1

Pin	Colour	Description
1	White	BtB Signal
2	Shield (white)	Shield (BtB)
3	White/Yellow	+5V
4	White/Blue	Light
5	White/Grey	ON LED
6	White/Red	Standby
7	White/Green	IR Data
8	White/Black	GND
9	White/Brown	Sense

IR-eye without Autocontrast

BeoSystem 4 (using Network Link Product Cable)

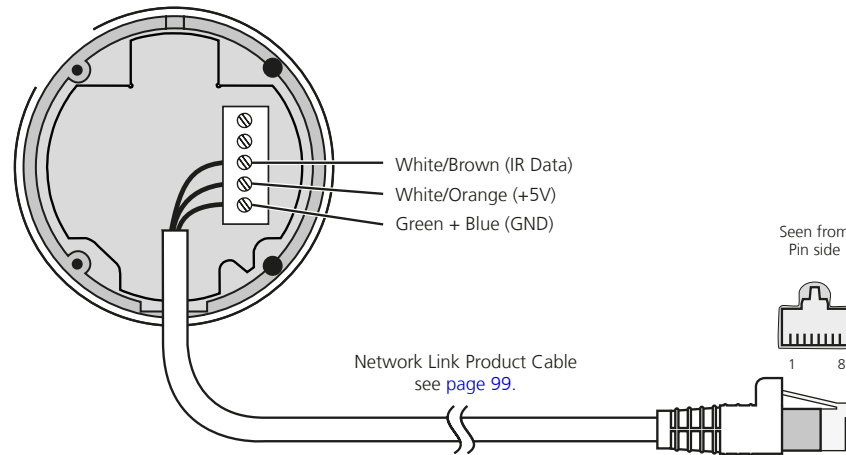

Part No.	Description	pcs. per package
8087030	IR-eye without autocontrast	1
6271026	Choose a Network Link Product Cable or make one using Network Link Installation Cable - up to 100 m/ 328 ft; see page 99.	
6271027		
6271028		
6250027		

Pin	Colour	Description
1	White/Orange	+5V
2	Orange	Not used
3	White/Green	Not used
4	Blue	GND
5	White/Blue	Not used
6	Green	GND
7	White/Brown	IR Data
8	Brown	Not used
Shield	Braided shield	Data GND

BeoSystem 4 (using IR cable, BLC NL/ML, RJ45 to pig tail)

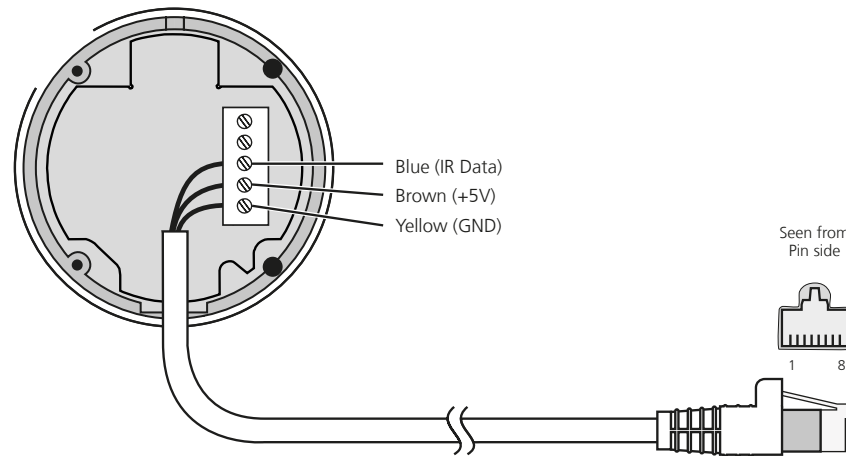

Part No.	Description	pcs. per package
8087030	IR-eye without autocontrast	1
6271239	IR cable BLC NL/ML, RJ45 to pigtail, 10 m / 33 ft, White	1

Pin	Colour	Description
1	Brown	+5V
2	White	Not used
3	Green	Not used
4	Yellow	GND
5	-	-
6	-	-
7	Blue	IR Data
8	-	-

BeoSystem 3

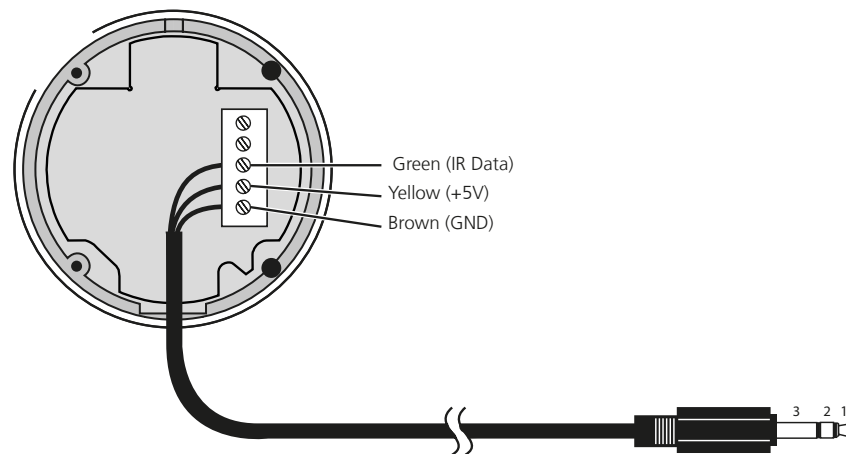

Part No.	Description	pcs. per package
8087030	IR-eye without autocontrast	1
6270758	Cable for IR-eye without autocontrast, Mini Jack Stereo	1

Product socket
seen from
solder side

Pin	Colour	Description
1	Yellow	+5V
2	Green	IR Data
3	Brown	GND



BeoLab 90 (using Network Link Product Cable)

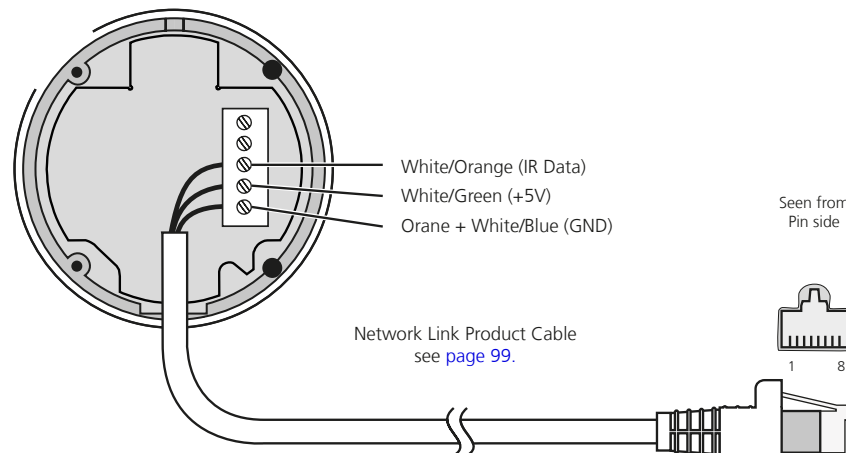

Part No.	Description	pcs. per package
8087032	IR-eye without autocontrast	1
6271026	Choose a Network Link Product	
6271027	Cable or make one using	
6271028	Network Link Installation Cable	
6250027	- up to 100 m/ 328 ft; see page 99 .	

Pin	Colour	Description
1	White/Orange	IR Data
2	Orange	GND
3	White/Green	+5V
4	Blue	Not used
5	White/Blue	GND
6	Green	Not used
7	White/Brown	Not used
8	Brown	Not used
Shield	Braided shield	GND_C

IR-blaster cables

Part No.	Description	pcs. per package
6271204 A	2 x IR-blaster cable w RJ45 7.5 m / 24.6 ft, Ø 1.1 mm	1
6271234 B	IR-blaster cable w RJ45 7.5 m / 24.6 ft, Ø 1.1 mm	1
8330352 C	IR blaster cable w Mini Jack, Mono, 7.5 m / 24.6 ft, Ø 1.1 mm	1

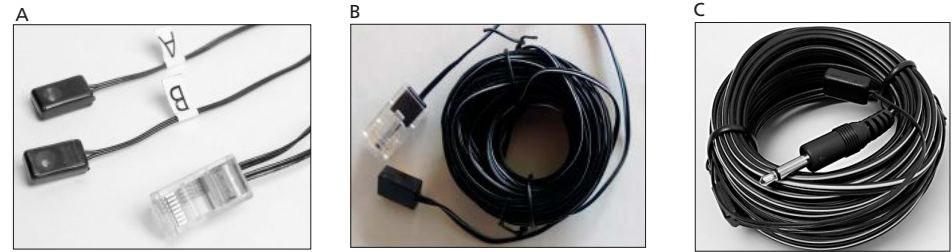

The illustration shows the connections in an RJ45 plug, when PUC A and PUC B wires are connected. Information relevant when shortening cables.

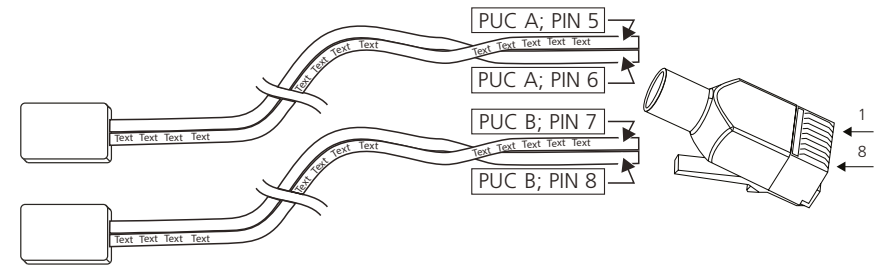

Adaptor cables - IR-blaster

Part No.	Description	pcs. per package
6271233 A	IR-blaster Adaptor, Mini Jack 3.5 mm, Mono, Female to RJ45 (PUC A) 0.2 m / 0.7 ft	1
6271214 B	2 x Mini Jack, Mono, Ø 3.5 to RJ45 7.5 m / 24.6 ft, Ø 1.1 mm	1
6271086 C	Mini Jack, Mono to Mini Jack, Mono 2.5 m / 8.2 ft, Ø 1.1 mm	1
6271097 C	Mini Jack, Mono to Mini Jack, Mono 10 m / 33 ft, Ø 1.1 mm	1

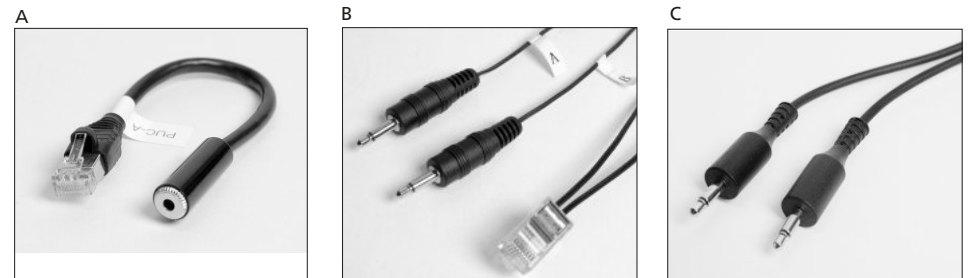

Atlona optocoupler IR cables

Below is a list of Optocoupler cables used with various Bang & Olufsen products and various Atlona products. Bang & Olufsen Part No.s are used for ordering inside Europe. All other orders are made directly to Atlona using Atlona Part No's.

Bang & Olufsen Part No.	Atlona Part No.	Connectors	Dimensions	pcs. per package
8780332 A	AT-BO-RJ45-BW-1MIR	RJ45 to Captive Screw Connector Optocoupler IR cable	1 m / 3.3 ft	1
8780313 B	AT-BO-HD4V110-1MIR	3.5 mm Mini Jack male to 3.5 mm Mini Jack (Mono/Stereo) for Atlona PRO0HD Rx box w Bang & Olufsen TV and AT-HD4-V110SR HDMI extender kit *) and **)	1 m / 3.3 ft	1
8780312 C	AT-BO-PRO3HD-1MIR	3.5 mm Mini Jack male to 3.5 mm Mini Jack (Mono/Stereo) for Atlona PRO3HD Rx box w Bang & Olufsen TV *) and **)	1 m / 3.3 ft	1
8780311 D	AT-BO-PRO2HD-1MIR	3.5 mm Mini Jack male to 3.5 mm Mini Jack (Mono/Stereo) for Atlona PRO2HD Rx box w Bang & Olufsen TV *) and **)	1 m / 3.3 ft	1

Note: Bang & Olufsen Part numbers are used for ordering in EU, CH, N, RU and African countries . Ordering in other countries is made from Atlona using Atlona Part numbers.

*) With extender cable, Part. No. 6270794 (black), the optocoupler cable can be extended 3 m / 10 ft.

**) Adaptation to RJ45 socket; see "Adaptor cables - IR-blaster" on [page 124](#)

Atlona IR cables

Below is a list of IR cables used with various Bang & Olufsen products and various Atlona products. Bang & Olufsen Part No.s are used for ordering inside Europe. All other orders are made directly to Atlona using Atlona Part No's.

Bang & Olufsen Part No.	Atlona Part No.	Connectors	Dimensions	pcs. per package
8780339 E	AT-BO-RJ45-UHD-1MIR	RJ45 to Captive Screw Connector	1 m / 3.3 ft	1
8780340 F	AT-IR-CS-TX	IR blaster to bare wire	1 m / 3.3 ft	1
8780350 G	AT-LC-CS-IR-2M	3.5 mm Mini Jack Mono to bare wire	1 m / 3.3 ft	1

Note: Bang & Olufsen Part numbers are used for ordering in EU, CH, N, RU and African countries . Ordering in other countries is made from Atlona using Atlona Part numbers.

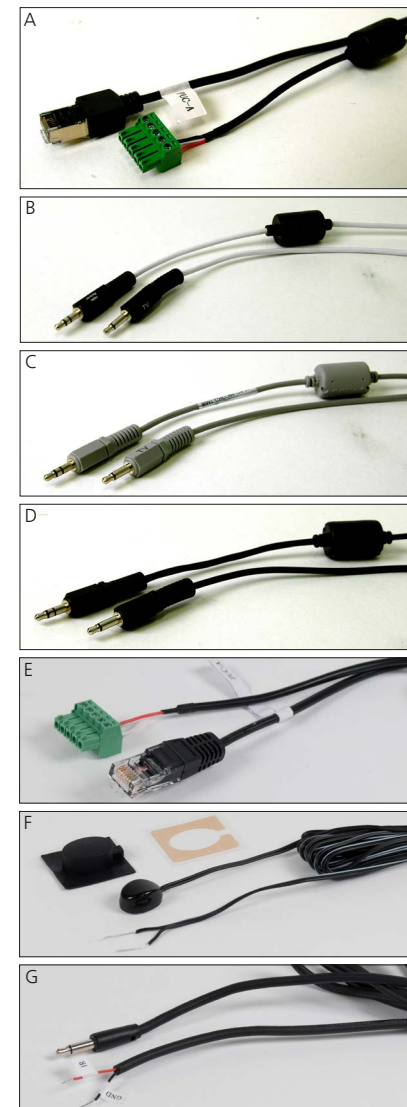

Connectors - jacks - plugs - sockets

DIN plug, male

Plugs for the relevant cables, e.g. Power Link, Datalink etc.

Part No.	Connector	Colour	pcs. per package
7220163	DIN 7-pin	Black	1
7220688	DIN 7-pin	Grey	1
7220701	DIN 7-pin angled	Grey	1
7220573	DIN 8-pin	Black	1
7220345	DIN 8-pin	Grey	1

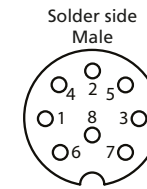

DIN socket, female

Part No.	Connector	Colour	pcs. per package
7220235	8 pin DIN female	Grey	1

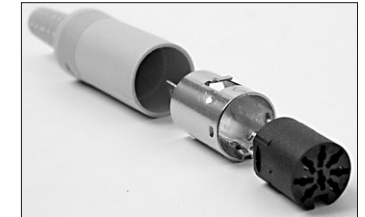
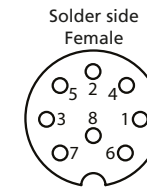

Master Link plug

Master Link plug for fitting on Master Link cable. Fitted using ML tool.

Note:
Discontinuation of black Master Link cables and plugs.
When stock of black cables and plugs are sold out, the white versions will be offered instead.

Part No.	Connector	Colour	pcs. per package
3390548	ML	Black	25
3390558	ML	White	25



F-connector insert

F-connector insert that fits into Network Link wall plates, keystone prepared wall plates and brackets for cabinets and racks.

Part No.	Connector	Colour	pcs. per package
7221628	F-connector	White	1



SCART 21-pin-out

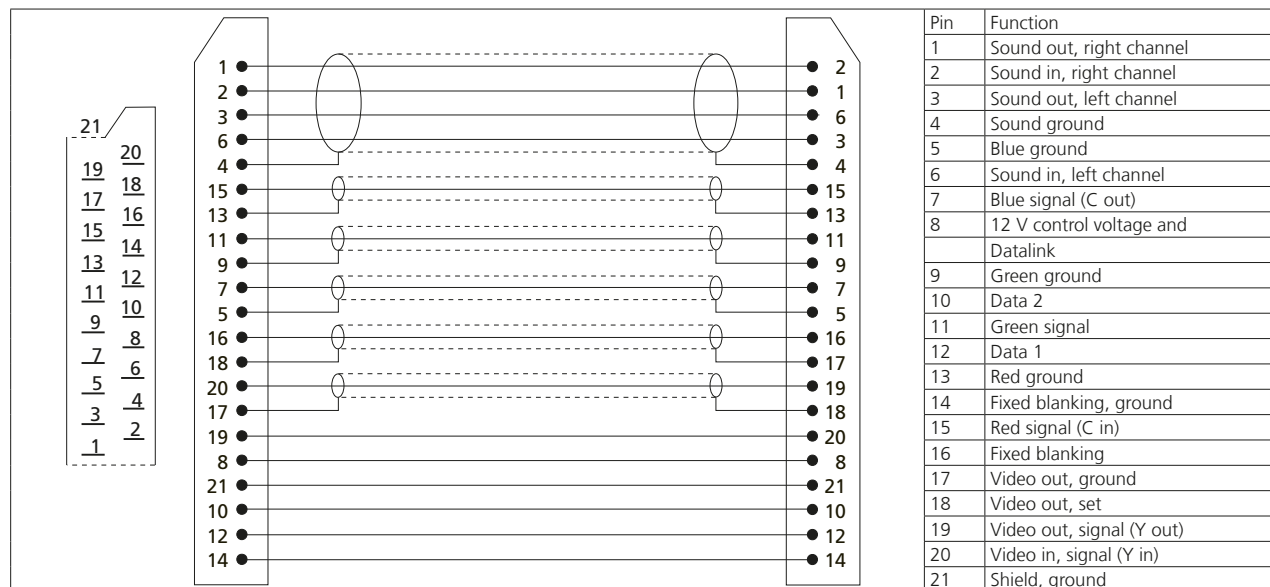

SCART to SCART product cable

Part No.	Length	Connector	Colour
6270510	0.75 m / 2,5 ft	SCART - SCART	Black

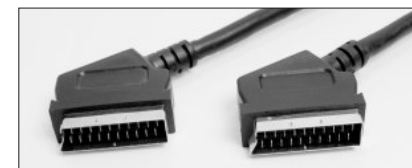

SCART to A/V adaptor

Part No.	Length	Connector	Colour
6270106 A	3.0 m / 10 ft 0.2 m / 0.66 ft	SCART male - SCART male + Mini Jack female mono + Mini DIN 4-pin	Black
6270672 B	3.0 m / 10 ft	SCART male - 3 x RCA male + Mini DIN male 4-pin	Black
6271215 C	1.0 m / 3.3 ft	SCART female - Mini DIN male 9-pin	Black
6271217 D	3.0 m / 10 ft	SCART male - Mini DIN male 9-pin	Black

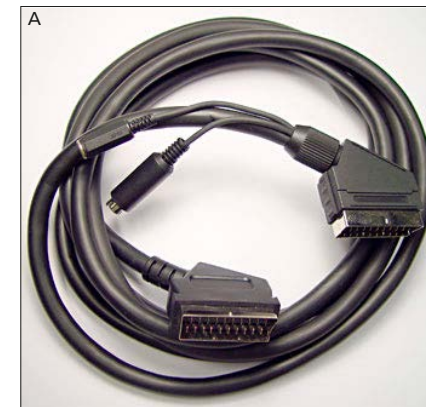

Pin-out shown for 6271215		
Pin	Colour	Use
1	-	-
2	Brown	Right_IN
3	-	-
4	Black/Brown shield	GND
5	Blue shield	GND
6	Black	Left_IN
7	Blue	B
8	White	AVL
9	Green shield	GND
10	-	-
11	Green	R
12	-	-
13	Red shield	GND
14	Yellow shield	GND
15	Red	Red
16	Yellow	FB
17	-	-
18	Orange shield	GND
19	-	-
20	Orange	CVBS_IN
21	Shield	GND

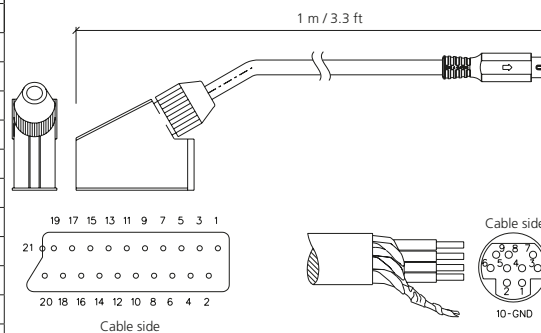

Pin	Colour	Description
1	Red	Red
2	Green	R
3	Blue	B
4	Orange	CVBS_IN
5	Yellow	FB
6	White	AVL
7	Black	Left_IN
8	Black/Brown shield	GND
9	Brown	Right_IN
10	Shield	GND

RJ45 jacks/socket - for wall outlet and brackets

Straight connector used for wall outlet and brackets.
 Installation cable goes straight into the connector
 Angled connector used for wall outlet
 Installation cable goes into the side of the connector

Part No.	Description	pcs. per package
7221710 A	RJ45 socket for wall outlet - straight	24
7221711 B	RJ45 socket for wall outlet - angled	25

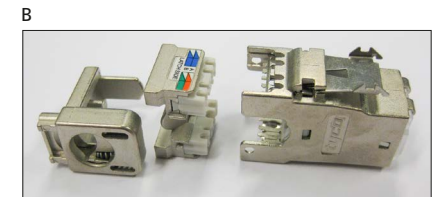

RJ45 plug w. screen for Cat cable

Part No.	Connector	Colour	pcs. per package
7221248	RJ45 for Cat cable	White	25
7221648	RJ45 for Cat cable	Black	25

See assembly tool [page 93](#).
 See instruction for mounting RJ45 plugs [page 144](#).
 See Cat cable - colour coding of wires [page 169](#).

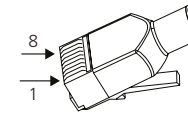

RJ45 plug for Ø 2.5 mm PL cable

Note:
 When the RJ45 plug is used with RJ45 wall outlet socket, see [page 129](#), use RJ45 plugs marked with a black stroke on the front of the plug and marked "new" on the packaging label.

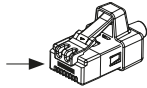

RJ45 connector assembled without crimp tools; 4 wires + braided shield - (both black cover and white cover included). Used with Ø 2.5 mm/ 0.1" Power Link cable - connecting Pins 4, 6, 7 and 8.

Part No.	Connector	Colour	pcs. per package
3390323	RJ45 w. 4 pins	Black / White	25

See mounting instruction [page 150](#)

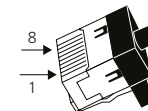

Installation accessories

Wall socket, Master Link socket

Wall socket with Master Link socket. Solder-free terminals Used for Master Link connection, between rooms or between Master Link product and wall socket.

Part No.	Dimensions	Colour	Comments
7210938	72 x 50 mm / 2.8 x 2"	White	DK
7210940	80 x 80 mm / 3.1 x 3.1"	White	Euro



Wall socket, DIN 8-pin

Wall socket with 8-pin DIN bushing with solder terminals. Used as plug connection between audio system and wall socket.

Part No.	Dimensions	Colour	Comments
7210607	49 x 49 mm / 2 x 2"	White	DK
7210512	80 x 80 mm / 3.1 x 3.1"	White	Euro



Outdoor socket - base

Outdoor socket for ML and MCL transceiver.

Part No.	Dimensions	Comments
3132321	75 x 125 x 175 mm / 3 x 5 x 3"	-



Flush-fit kit for ML transceiver - round - in-wall

Used for invisible in-wall installations; solid walls respectively partition walls. See [page 87](#).

Part No.	Dimensions	Comments
3375187 A	Ø 72 mm x 55 mm / Ø 2.8" x 2.2"	Solid walls
3375188 B	Ø 72 mm / Ø 2.8"	Light partition walls

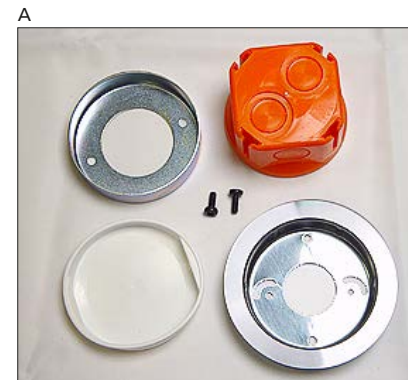

Junction boxes

The following restrictions should be observed for all junction boxes.

Note: Never place junction boxes in an un-insulated loft and the like; place in indoor environment conditions only.

Note: Wires must never be soldered to the AMP barrel terminals.

Power Link Junction Box

The junction box is able to handle all cable dimensions (i.e. wire gauges) delivered through Bang & Olufsen. Able to assemble up to 3 cables and up to 8 wires.

Part No.	Connector	h x w x d
3132055	-	30 x 30 x 17 mm 1.2 x 1.3 x 0.7 "

See mounting instruction [page 152](#)

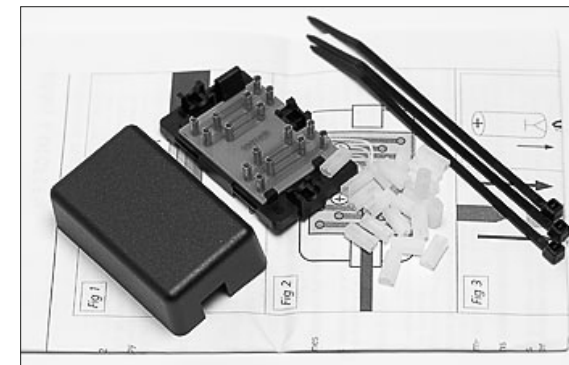

Master Link socket - wall outlet

Master Link socket for fitting in extra wall socket (with blanking cap).

Part No.	Dimensions	Comments
8009947		Solid walls

- Remove approx. 50 mm / 2" of the insulation on the cable.
- Remove the foil screens.
- Twist the three non-insulated ground wires together.
- Mount the ground wires into the screw terminal A.
- The insulated wires have to be mounted in the terminals B (according to the numbers and colour coding); see [page 97](#).
- Place the wire along the gaps in the terminals A, so that they touch the opposite side of the terminals (see illustration) and push the wires down by means of the tool C.

Note: No more than two wires may be mounted in each terminal.

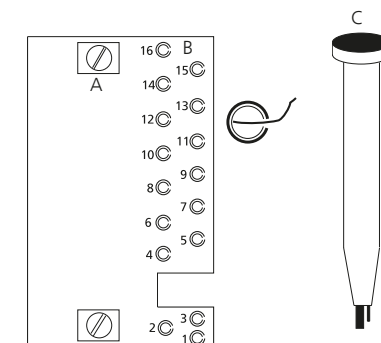
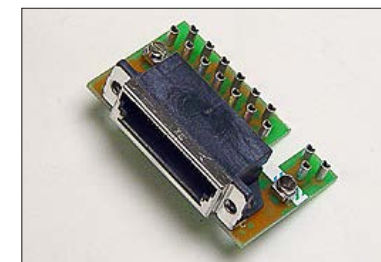

Master Link Junction Box - small

Used for shortening ML cables, for cable colour change and for connecting products.

Part No.	Colour	Comments
3132170	Black	Small
3132197	Grey	Small
3132220	White	Small



- Place the box on a solid base, and take it apart as shown in A).
- Strip off approx. 10 cm of the outside cable jacket.
- Remove the foil shield and mount the three stripped ground leads to the two outermost terminals. To stabilize the cable, fasten the first ground lead to the outermost terminal at both sides of the box (see B)). Fasten the last two ground leads to the second outermost terminal (see C)).

Note: all ground terminals are interconnected.

- Mount the nine insulated conductors in the terminals in accordance with the colour code; see D). Use the enclosed tool as shown in E).

Note: White/Blue and Pink are short-circuited in the junction box.

- Fasten no more than two leads in each terminal.
- Cut off any excess lead.

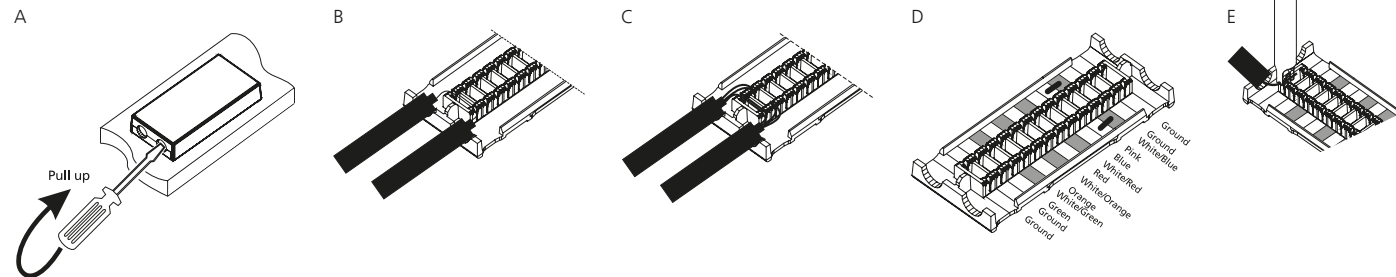

Master Link Junction Box - large

Used for shortening ML cables, for cable colour change and for connecting products.

Part No.	Colour	Comments
3375189	Black	Large

- Place the box on a solid base, and disassemble it.
- Strip off enough of the outside cable jacket to allow it to reach into the small junction box, see A).
- Remove the foil shield and mount the three stripped ground leads in the two outermost terminals. To stabilize the cable, fasten the first ground lead to the outermost terminal at both sides of the box (see fig. 2). Fasten the last two ground leads to the second outermost terminal.
Note: all ground terminals are interconnected.
- Mount the nine insulated conductors in the terminals in accordance with the colour code, see fig. 2. Use the enclosed tool as shown in fig. 3.
Note: White/Blue and Pink are short-circuited in the junction box.
- Fasten no more than two leads in each terminal.
- Cut off any excess lead.

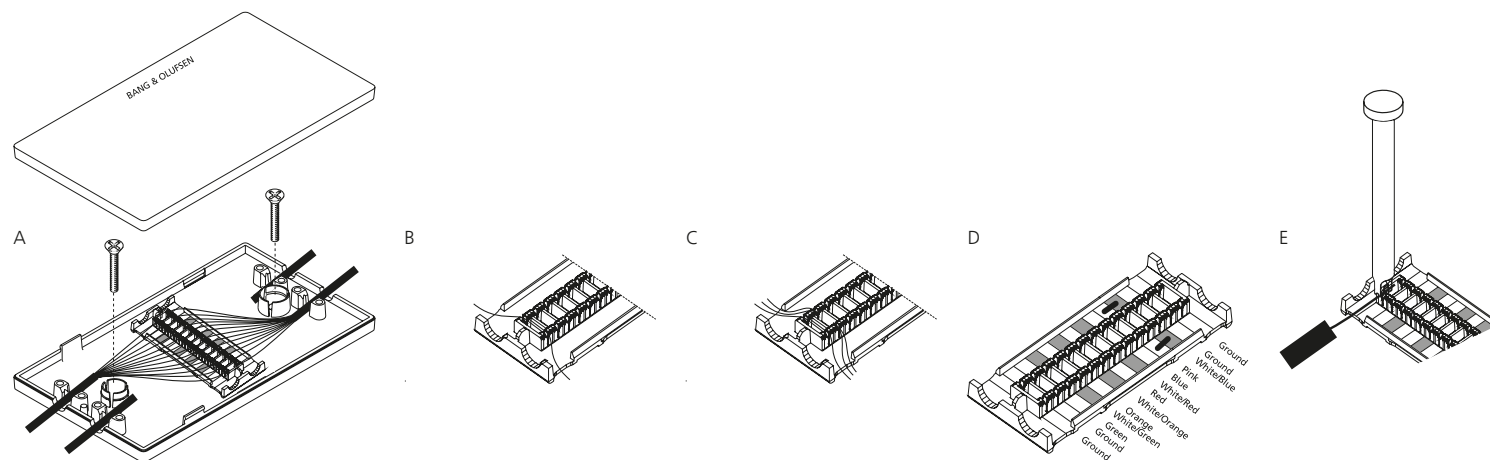
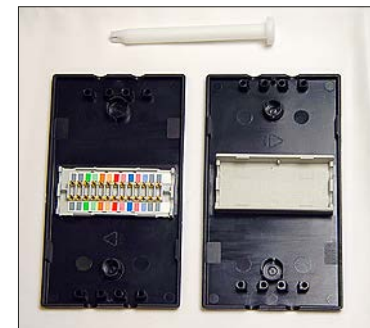

Master Link Distributor

The Master Link Distributor assembles master link connectors from various products - serving the distribution of ML signals.

Note: To avoid problems with subsequent deadlock, always disconnect all Master Link products in the setup from mains before plugging Master Link Cables in the Master Link Patch Module.

Part No.	Colour	Comments
3634051	Black	-

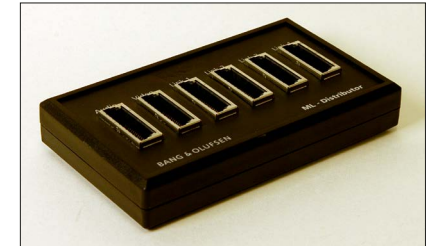

Patch Modules

Master Link Patch Module and Power Link Patch Module for cabinet mounting.

Note: To avoid problems with subsequent deadlock, always disconnect all Master Link products in the setup from mains before plugging Master Link Cables in the Master Link Patch Module.



Part No.	Connectors	pcs. per package
8052351	Master Link	1
8052352	Power Link	1

Brackets for 19" racks

Network Link Bracket, connector for Patch Modules and RJ45 sockets in 19" rack

Part No.	Connectors	pcs. per package
3153286	For ML and PL Patch Module in Cabinets	1
3153269	For Network Link bracket for 24 pcs of RJ45 connectors in 19" cabinet	1

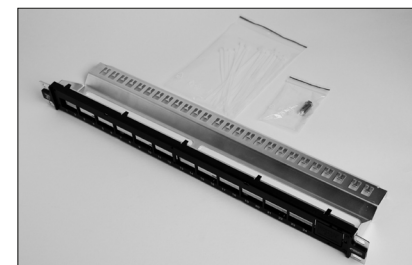
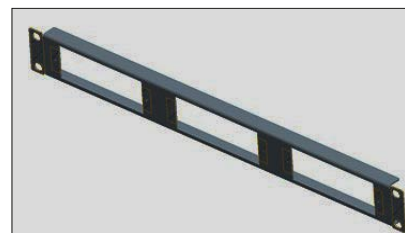

Wall Plates

Network Link Wall Plate, FUGA

Part No.	Colour	Comments
7211635	White	DK Fuga
3321471	White	DK Fuga, double



Network Link Wall Plate - UK

Part No.	Colour	Comments
3321476	White	UK, double

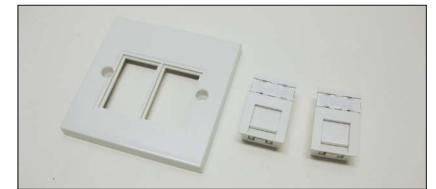

Network Link Wall Mount

Part No.	Colour	Comments
3321475	White	Surface mount for 2 connectors



Network Link Wall Plate

Part No.	Colour	Comments
7211637	White	DIN

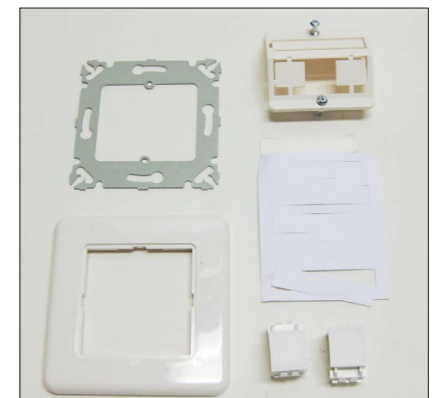

Cable Managers

Part No.	Colour	Comments
3390736	Black	Ø 10 mm / 0.4"
3390737	Pearl Grey	Ø 10 mm / 0.4"
3390738	White transparent	Ø 10 mm / 0.4"
3390739	Black	Ø 19 mm / 0.76"
3390741	Pearl Grey	Ø 19 mm / 0.76"
3390742	White transparent	Ø 19 mm / 0.76"
3390743	Pearl Grey	Ø 25 mm / 1"
3390744	White transparent	Ø 25 mm / 1"
3390745	Black	Ø 25 mm / 1"

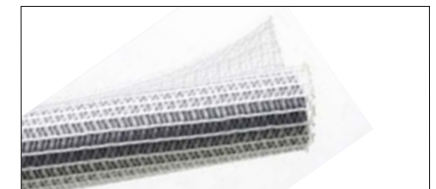
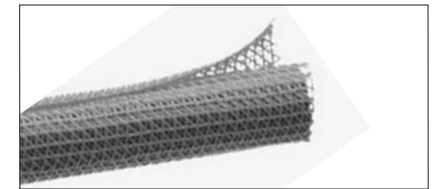

Various

Galvanic isolator

Used for isolation between incoming antenna signal and Network Link installation

Part No.	Connectors	Length	pcs. per package
8039004	Aerial connectors	-	1



Nanoperm coil

Only use if noise is experienced in speakers

Part No.	Connectors	Length	pcs. per package
6710038		-	1



Balanced to non balanced converter box

For speakers with non balanced input only
 BL 4000 MK I, BL 6000, BL 8000, older active speakers and Newer speakers not using ICEpower technology.

Part No.	Connectors	Comments	pcs. per package
3376078		EU	1

UK: not available
US: not available
AUS: not available



Assembly of connectors - sockets (jackets) and plugs

Assembly of RJ45 connector (socket/jacket) - for wall outlet - Network Link Installation Cable

Tool for stripping installation cable and crimp the connectors; see [page 93](#). See Cat cable - colour coding of wires [page 169](#).

Instructive video

See: [BeoWise > TRAINING > Start BEOCADeMY > RESSOURCES > Welcome Page Contents > BeoCasts > Assembly of Network Link connector.](#)

- 1 S/FTP cable: prepare the cable and cut the pair foils as shown.
F/FTP cable (compact cable): prepare the cable and cut the pair foils as shown.

Note: The metal braid (S/FTP), metal foil (F/FTP) and drain wire (if any) must be in contact with the clamp.

- 2 Colour coding according to T568 A and T568 B is shown on the connector. TIA/EIA 568 B is used.

See Cat cable - colour coding of wires [page 169](#).

Important !

Ensure that you use the same wiring system A or B (colour combination) at both ends. See [page 99](#).

If the connector is not assembled correctly, please take a new one.

Bang & Olufsen do not recommend to reuse the connector.

- 3 Push the cable clamp to open it.

- 4 Insert the cable through the hole until pair foil is visible on the opposite site. Release the cable clamp (the braid shield must fit tight over the cable jacket).

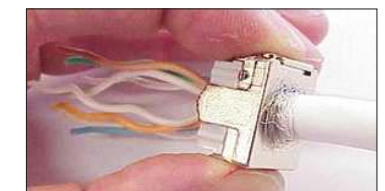
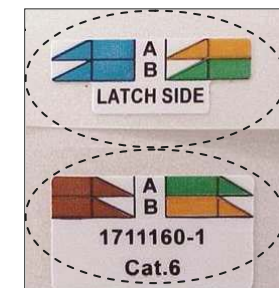
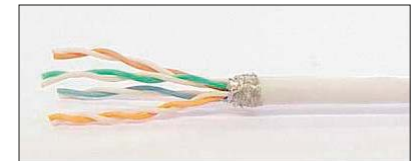

5 Sort the wires and place them in slots according to relevant colour coding (step 2).

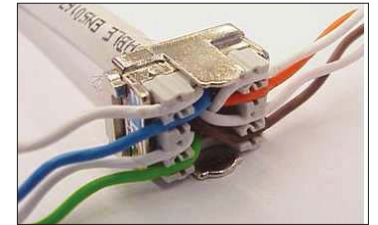

6 Locate the rear housing (step 5) into the front housing until it is engaged.

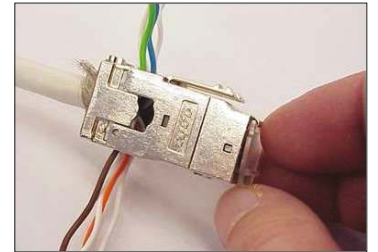

7 Position the pre-assembled jack into the tool.

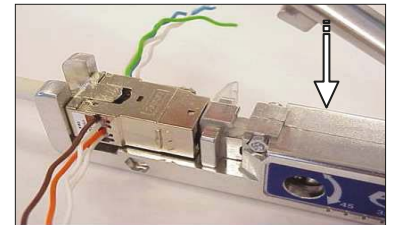

8 Squeeze the handle down until the back part latches into the front part. The wires are cut automatically. Remove wires in closed position.



9 The connector is now terminated and ready to be applied to the environment application.



10 The jack fits in cut-out as the drawing shows; step 11.

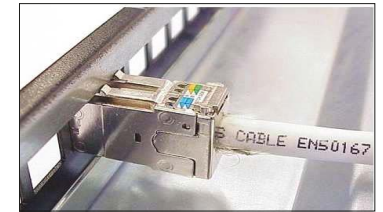

11 Only for reference indicating: Hole dimensions:

Hole dimensions: 14.78 mm /5.82" × 20.07 mm /7.90"

Material thickness: min. 1.47 mm /0.58" and max. 1.60 mm /0.63"

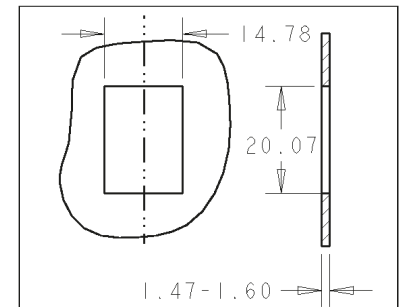

12 For re-opening, use a small screw driver for A) unlocking the two side latches ...

Note: Bang & Olufsen do not recommend to reuse the connector.

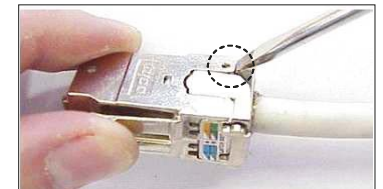

13 ...and for B) separating the front and the rear part.

Note: Bang & Olufsen do not recommend to reuse the connector.



Assembly of RJ45 plug for Cat 7 Network Link Product Cable

Important !

Ensure that you use the same wiring system A or B (colour combination) at both ends. TIA/EIA 568 B is used here.

Instructive video

See: [BeoWise > TRAINING > Start BEOCADeMY > RESSOURCES > Welcome Page Contents > BeoCasts > Assembly of RJ45 plug.](#)

- 1 Slide the plug boot (white sheath) onto the cable.
- 2 Insert the Network Link product cable into the tool for cutting through the cable jacket approx. 25 mm / 1" from the end of the cable.
Note: Turn the cutting tool in the direction of the small arrow.
- 3 Strip off the cable jacket.
- 4 Fold the outside braid shield back over the jacket.
- 5 Insert the Network Link Product Cable into the tool as shown for cutting the foil shield of the twisted pairs.
Note: The foil shield must protrude approx 2 mm / 0.1" from the outer braid shield.
Only turn the tool one round.
- 6 Twist and pull off the foil shield of each twisted pair.

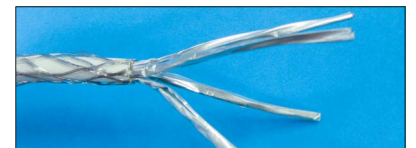

7 Slide the plug shield over the cable jacket and cable braid shield.
Push and twist until in place as shown.

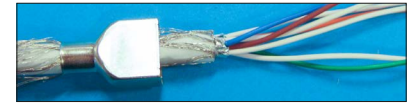

8 Arrange the wires according to the wiring type used and hold them firmly (the example shown in the picture is with the Network Link product cable).
See Cat cable - colour coding of wires [page 169](#).

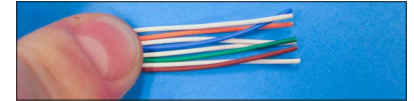

9 Place the wires in the wire holder.
If needed the wires may be trimmed to be equally long before applying the wire holder.

In this handbook the **TIA/EIA 568 B** standard is used for colour coding of wires in the Cat connectors.

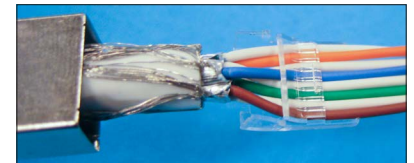

10 Trim all conductors using an appropriate tool along the end of the wire holder.

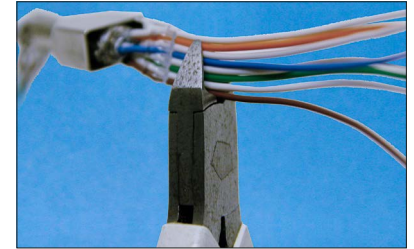

11 Apply the contact housing over the wire holder. Make sure that all wires are fully inserted to the front of the plug.



12 Gently push and twist the plug shield until it covers the contact housing.

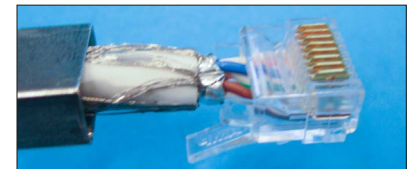



13 All sub-parts of the RJ45 plug shown in proper position.

Attention: It is very important that the metal shield is pressed firmly forward against the plastic part of the connector and aligned! In case it is not in proper place (see picture 16) the shield will slide away from the connectors. A fault symptom is buzzing sound when used to connect speakers, or decreased performance when used as Network Link cables and LAN cable.

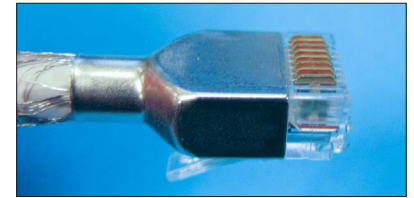

14 Place the assembled plug in the crimper tool as shown.

Note: Observe the above instructions before crimping!



15 Trim away all braid shield as close as possible to the edge of the metal shield of the connector.

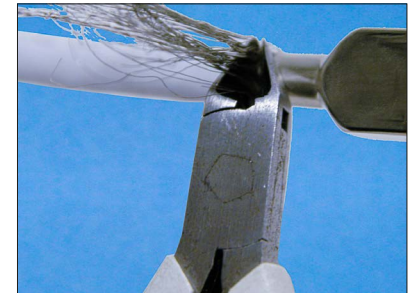

16 The RJ45 plug is now successfully crimped and trimmed.



Correct



In-correct



17 Slide the plug boot (white sheath) over the crimped plug and shield.

The RJ45 plug is ready for use.



Assembly of Master Link plug for Master Link Cable

- 1 The tool kit consists of 3 tools. See [page 94](#).
 Tool A for removal of the cable jacket
 Tool B for making connections with the inner wires of the cable and
 Tool C for crimping the chassis ferrule.

- 2 Use tool A to remove 35 mm / 1.4" of the cable jacket. This is done by pushing the cable through the small hole in the tool in such a way that the cutter is on the left (as illustrated). Turn the tool in the direction of MIN (anti-clockwise) a couple of times, and then pull off the jacket.

- 3 Remove the white foil.

- 4 Pull the black cover and the chassis ferrule onto the cable. The wider end of the ferrule must point towards the plug – cable end.

- 5 Unwind the twisted pairs. Remove the 3 foiled screens. Use a small sharp tool, e.g. a small screwdriver to trim away the foil. Tear outside first - this makes it easier to remove the foiled screens with your fingers. Straighten each wire to make sure they do not twist.

- 6 Bend the 3 ground wires backwards along the outer sleeve.
 Mount the small plastic wire holder over the wires.

- 7 Mount the wires and the ribbon cable in the clear plastic wire holder as shown. See [page 97](#).

1..... White/Green	12..... Pink
2..... Green	13..... White/Orange
3..... White/Blue	14..... Orange
4 to 10..... Ribbon cable	15..... White/Red
11..... Blue	16..... Red

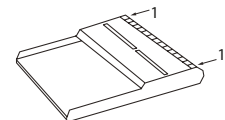

8 Press the plastic part as close towards the cable as possible.

Cut the wires so they are protruding approx. 9 mm outside the plastic part.



9 Mount the contact housing part over the wire holder.



10 Place the plug into tool B.

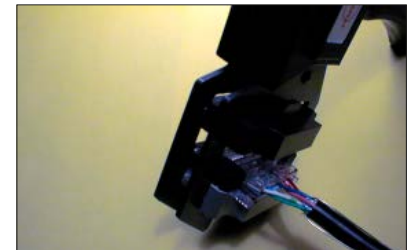

11 Push the wire completely in and check this on the left side of the tool. Activate the tool to crimp the plug onto the wires.

Note: It is very important that the plug is pressed firmly forward into the tool!
If the wires are not completely in, it will result in poor connections and consequently intermittent fault in the Master Link installation.

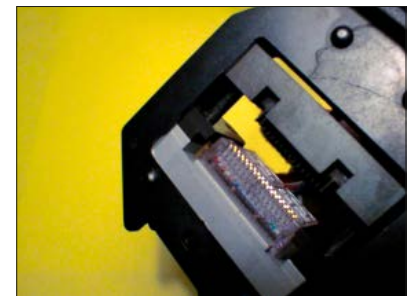

12 The connections to the wires have now been made.



13 Mount the shield on the plug, and note to place the side with the two holes (indentations) on the same side as the connectors of the plug.



14 Press the shield together with the plug part until a click is heard.



15 Bend the 3 chassis wires upwards along the shield.

Push the chassis ferrule up and press it thoroughly over the shield.

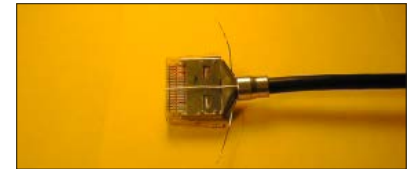

16 Place the plug into the inner jaws of tool C (the largest hole) and crimp the part nearest to the shield.



17 Place the plug into the outer jaws of tool C (the smallest hole) and crimp the outer part of the chassis ferrule.

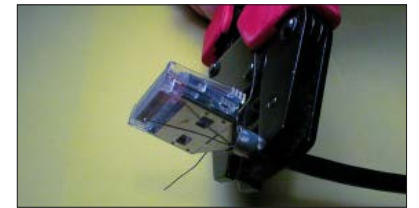

18 Cut off the 3 chassis wires as close to the chassis ferrule as possible.

Pull up the outer cover and push it into place.



19 The plug is now assembled and ready for use.



Assembly of RJ45 plug for Ø 2.5 mm Power Link cable - no-tool-mounting; see [page 129](#)

1) Strip outer jacket, stripping length: 18 mm / 0.7"

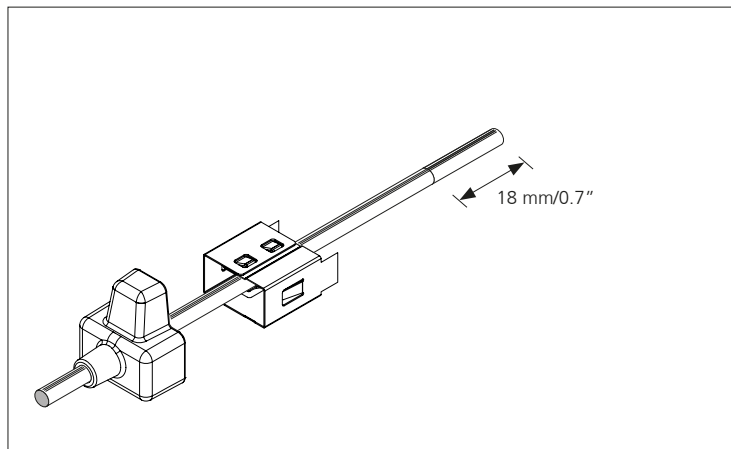

2) Twist braided shield into one wire
Shorten 4 coloured wires by 3 mm / 0.12"

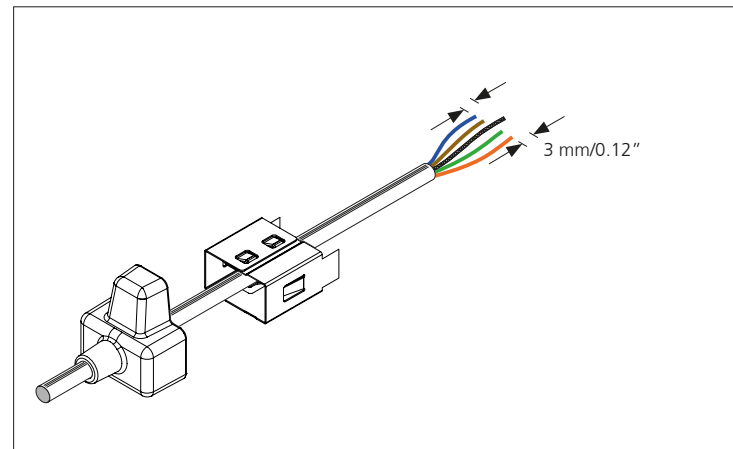

3) Place wires in plug part
Ensure correct order of coloured wires

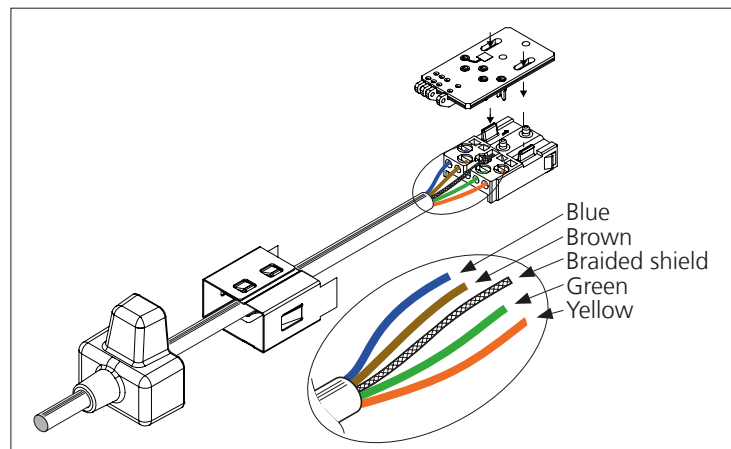

4) Clip PCB part onto plug part
Turn plug part onto cable

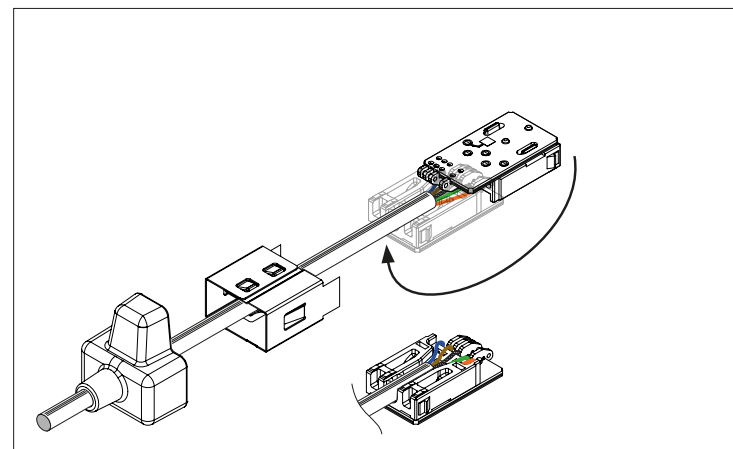

5) Fit cable into groove
Slide housing over plug part until a click is heard
Ensure that all sides of housing are in proper place

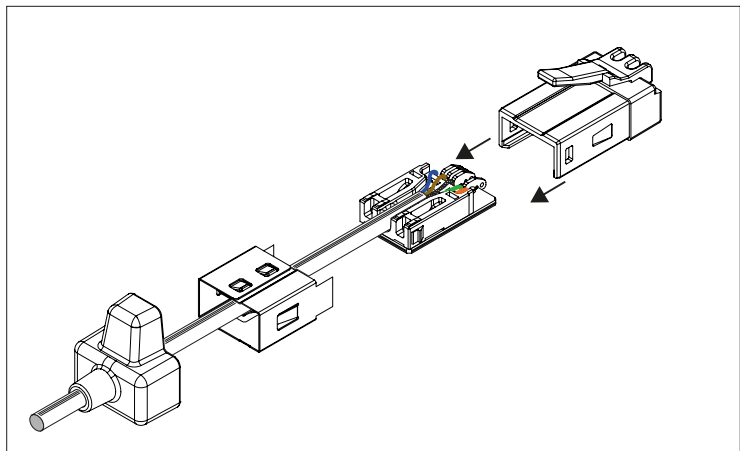

6) Slide shield over housing until a click is heard
(see proper position in next picture)

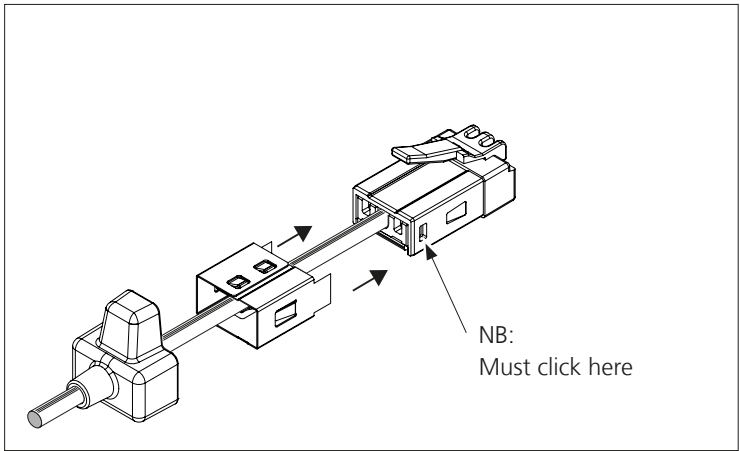

7) Slide hood over plug

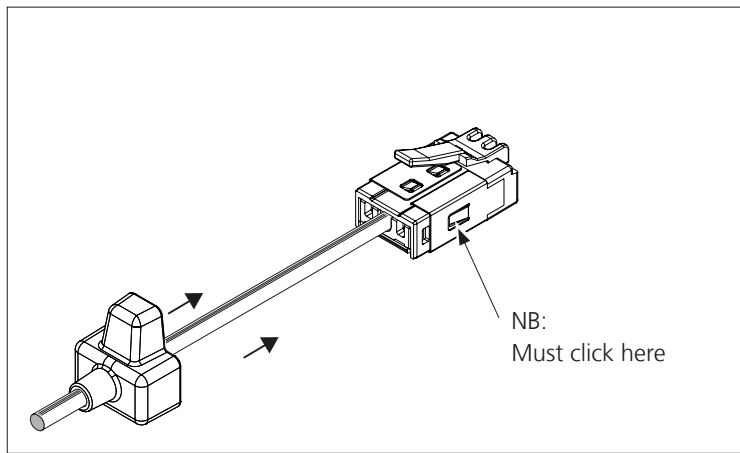

8) Assembled RJ45 plug and cable

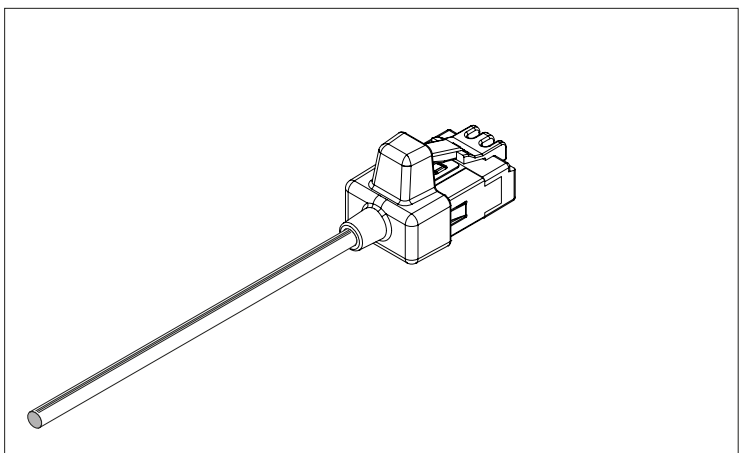

Assembly of Power Link cables - Junction Box - 8, 6 or 5 wire; see [page 132](#)

- 1) Strip outer jacket, stripping length: 30 mm/1.2"
 If braid shield is part of the cable, open braid of braid shield and twist 1/10 as a wire and strip away the remaining 9/10

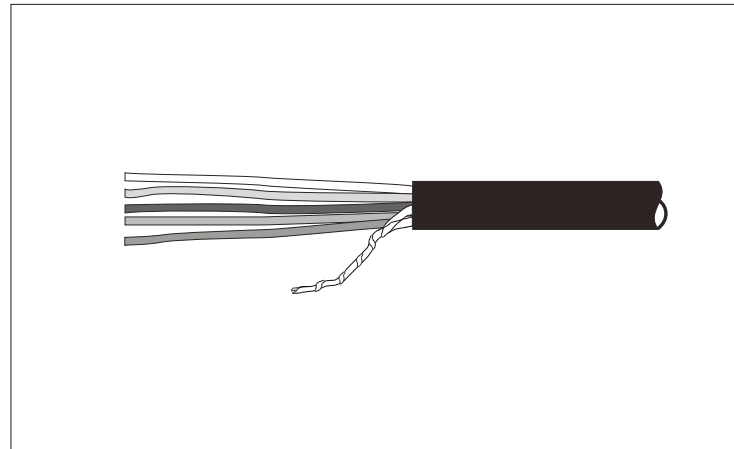

- 2) Place cables as indicated towards the centre and do not short-circuit (appropriate insulation material may be used).
 Fasten the cable using a cable tie

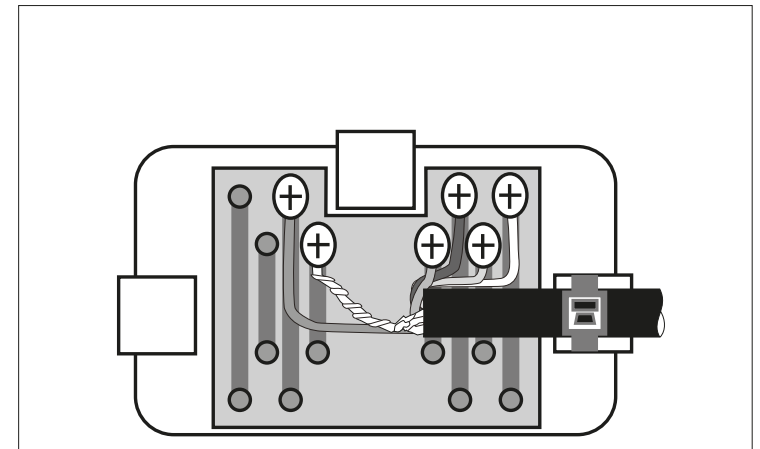

- 3) Connect wires to the AMP barrel terminals using stuffer caps
 - Use a screwdriver to mount stuffer caps.

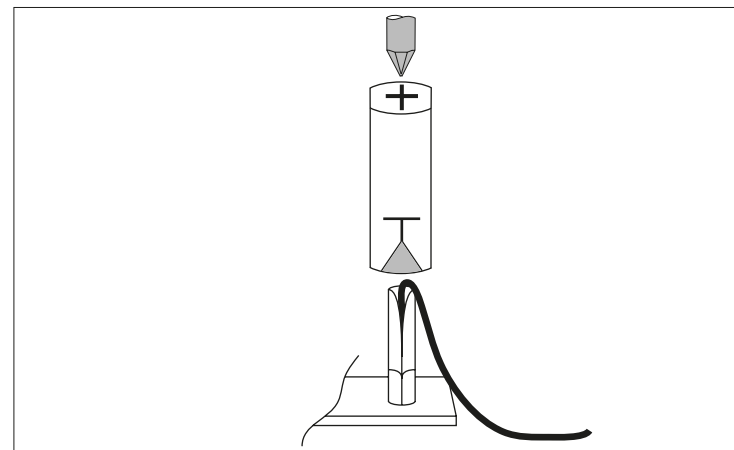

- 4) Connect wires from other cable(s) to the opposite AMP barrel terminals using stuffer caps* - Connect wires to the correct terminals (e.g. observe colour code)!

* A maximum of 2 wires per AMP barrel terminal is recommended

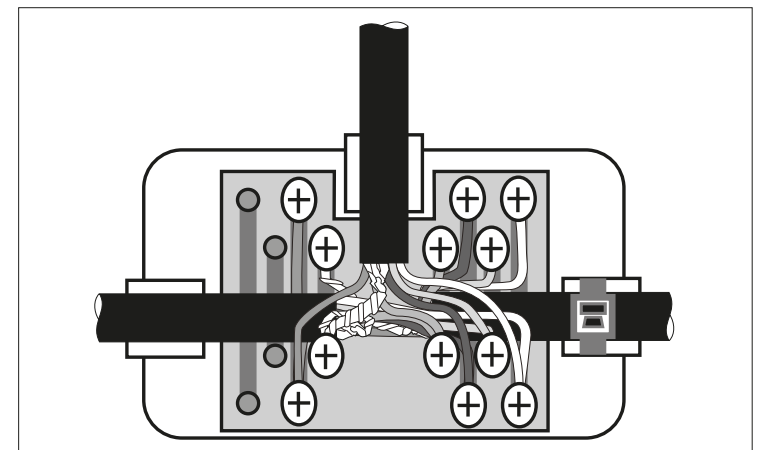

5) Fasten cables using cable ties.

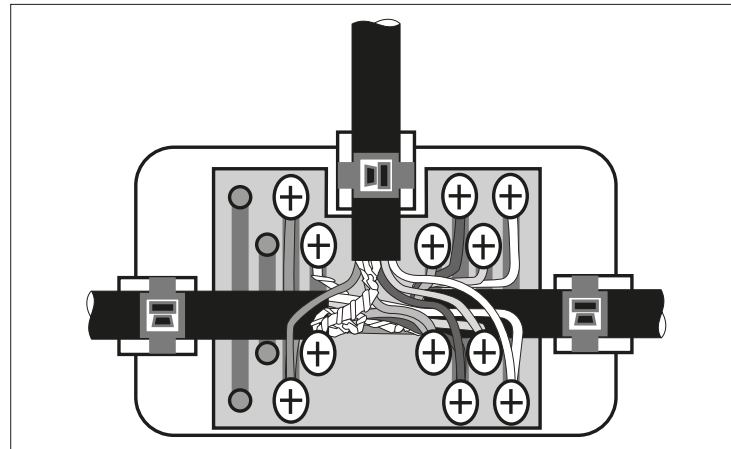

Troubleshooting

Troubleshooting LAN networks and Network Link networks

Initial checks regarding connection

The following checks may be useful when troubleshooting a LAN network and a Network Link network.

- Check cables. Use an Ethernet cable tester and remote ID locators to test that installations and product cables are having the correct connection; see [page 95](#).
- Check that routers, switches and other network equipment is supplied with power; i.e. check mains cables, Power Adaptors supply the correct amount of voltage and current, UPS, etc.
- When a B&O recommended Router is used, ensure that settings and subnetting is made correctly; see [page 56](#).
- Check that hosts (i.e. PCs, TVs etc.) are having an IP address inside the subnet used; see [page 55](#) and [page 56](#).
Example for the B&O Recommended Router: 192.168.100.1 with subnet mask 255.255.255.0.
Examples for the ISP router: could be either of the following addresses: 192.168.1.x; 192.168.0.x; 172.16.0.x; 10.0.0.x and typically with at subnet mask 255.255.255.0.
- Check that the DHCP server is set up correctly; see [page 56](#).
- If ping of an IP address is possible but it is not possible to enter a name for the destination, then there might be a DNS server problem or the DHCP server is set up in-correctly; see [page 56](#). DNS server IP addresses may be 8.8.8.8 and 8.8.4.4 (Note: these addresses are for Google DNS servers).
- Check that the IP address for the default gateway is set correctly: i.e. the address of the router e.g. 192.168.100.1; see [page 56](#) - the address entered under Router Details.
- If more than one wireless Access Point using the 2.4 GHz band is used, ensure that **Channel** field is set to **Auto**; see [page 57](#).

BonJour Browser

A browser that looks up info about the local network that the hand held device is connected to.

The App is named "Discovery BonJour Brower" on App Store and "BonJour Browser" on Play Store.

The BonJour services listed in the below table provides insight view of what is actually accessible on the local network:

BonJour Service	Used for	Used by (examples)	Typical port (dynamic ports)
_beo_settings	Detection of products for BeoSetup App	BeoSetup App	80 (TCP)
_beoconfig	Network Link services. It is used for leader election in system configuration, so one product will have this service at at time only	All Network Link products	Same as _beocore
_beocore	Network Link services	All Network Link products	5222 (TCP)
_beoremove	BeoNetRemote service	All "app" enabled products	8080 (TCP)

Drop out

When using 2.4 GHz wireless connections, dropouts may happen. Even checking if other nearby equipment is using the same channel as is used by the home router/Ap noise from electronics, not being a wireless transmitter/receiver can impact certain channels. Problems may be solved by changing to another channel. Choose either of these channels: 1, 6, 11; see [page 58](#).

Fing - network scanner

Fing is a freeware App that can be downloaded from App Store as well as Play Store. It is used to scan for IP addresses in the network that the device hosting the App is connected to. It is recommended to use the solution for Mobile Phones or Tablets.

Connectivity information

The following information may be useful in situations where the connections do not per automatic use the usual and default setup values. In such situations the installer has the possibility to setup the right network for the B&O connectivity.

-External communication (WAN)

In general IT IS NOT recommend to limit connections to the network for our products, as these services can change over time, and the following information and port-ranges may be extended without any notice.

Spotify

The router and firewall needs to allow traffic for Spotify both inbound and outbound, access needs to be granted at least to these IP ranges on port 4070: 78.31.8.0/21, 193.182.8.0/21. Spotify also needs UPnP enabled in the router.

Deezer

Deezer is based entirely on http/https, and requires access through port 80 and 443.

Qplay

No information available at this time.

Tuneln

The Tuneln API communication is through http and https (port 80 and 443), but the streams can come back on a large variety of protocols and formats, e.g. http, https, hls, icy, mms, rtsp and rtmp. Given that radiostations provided by Tuneln can use any available port for streaming, it is recommend allowing outgoing connections on all ports and addressing ranges.

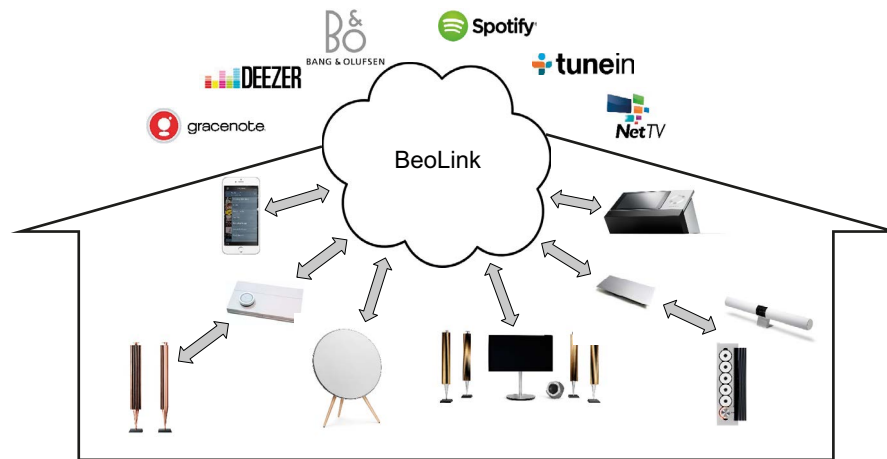

Connectivity - Fast Precision Streaming (FPS)

Precision Time Protocol (PTP)

Time synchronization for streaming is an important part of the MultiRoom experience, without it, we will not be able to play synchronized sound between products.

Multicast IP: 224.0.0.107 UDP: 3319/3320

Multicast IP: 224.0.1.129 UDP: 3319/3320

Unicast UDP: 3319/3320

Stream

Audio streaming between products in a multiroom setup is based on unicast.

Unicast UDP: 1234

Unicast UDP: 1235 (retransmission)

Unicast TCP: 1234 (keep alive)

Recommendations for wireless streaming between products

See "Good installation practice" [page 42](#).

BeoTool



The BeoTool App is designed to make an assessment of your Bang & Olufsen BeoLink Multiroom products. It will analyse and display the status of online services and offer reporting. The target group is certified installers of Bang & Olufsen products.

The BeoTool can be downloaded from App Store and following updates are offered when available.

The device with the app must be connected to the same network as the Bang & Olufsen products. The app is a simple tool with few screens for an easy overview.

Tap links at the bottom of the screen to switch between views.



The **Overview** view is seen to the right on this page as an example.

Activating **Help** will present a short introduction to the abilities of the tool:

The app will assist Bang & Olufsen installers both when setting up and also when troubleshooting installations.

The app will discover all Bang & Olufsen Network Link products on the network it is connected to and provide a detailed overview and status of fundamental service.

The tool will gradually have more functions that will assess the components already installed and provide assistance in pre-sales situations.

The tool supports all Network Link products and BeoLink Multiroom installations.



Troubleshooting HDMI networks

The following checks may be useful when troubleshooting an HDMI network.

- Check the LEDs of the room box (receiver boxes and transmitter boxes: Green LED must be lit - indicating it is power supplied. Yellow LED must remain constant - indicating the connection is synchronized. If blinking is seen there is a connection issue.
- Check that the correct HDMI In port is connected to the cable desired.
- If one product is unstable or fails, swap HDMI In cable to an HDMI In port that works. If problem is solved the cable may be connected to a wrong HDMI In port. If problem persists, check the cable from source to display.
- Check cables. It is important that all Cat cables in a connection for HDMI signals from source to destination are all Cat 7 cables; i.e. the shield must be connected all the way. If a Cat 5 cable is used e.g. in the patch panel/distribution frame, the shield is interrupted, and the signal and synchronization may be disturbed.
- Use e.g. an Atlona HDMI test kit: KIT-PROHD3; see [page 95](#). [To be ordered as usual for Atlona products].

The kit consists of:

- a 7" Portable Testing Monitor, AT-DIS7-PROHD, with resolution from 480p up to 1080p, 1920×1200 and 3D, and HDCP compliant with display indicator and built-in speakers.
- a signal generator, AT-HD800, supporting 13 test patterns which includes 5 × 3D and over 20+ resolutions, and also reads EDID that allows to view display capabilities (video and audio formats) HDMI in/HDMI for pass through EDID reading.
- an HDMI Recorder and Hot Plug Emulator, AT-HDSync, that read, copy or replicate almost any EDID.
- a rechargeable battery, AT-BAT-DIST7PRO, for the above two devices allowing up to 4 hours of use.
- a troubleshooting guide either included or that may be found on the home page: www.atlona.com.

The kit can test:

- HDMI cables.
- mixed cable installations where matrix', room box', HDMI cables and Cat cables are used.
- resolution.
- EDID.
- reveal synchronization issues.

Troubleshooting Master Link

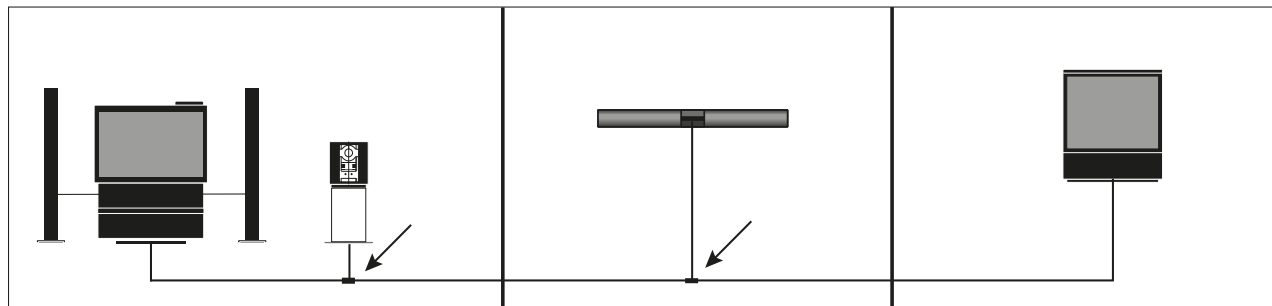

The isolation method is the first course of action when troubleshooting a Master Link installation. Start by disconnecting the link rooms in order to find out if the fault is in the main room or the link rooms. Then connect the link rooms one by one until the fault is discovered. This is a quick way of finding out if the problem is in the main room, or identifying the link room that is the cause of the problem.

If there are no junction boxes in the system, you can also disconnect the link rooms by disconnecting the Master Link plug from the products.

It is also possible to use the LED tester, which is a circuit tester used to locate poor connections and broken connections in an ML system. This tester allows you to localise faults very quickly in the individual wires of the ML cables. All products must be disconnected while these tests are done; see [page 96](#).

Short circuit ML-sense

In a system where two masters (e.g. BeoLink Converter configured as master) are connected and where the total length of the Master Link cable is over 20 m, you should make a short-circuit in the Master Link cable; see details below. This short circuit is incorporated into junction boxes, so if the system includes a junction box you do not need to create the short circuit.

The short circuit must be made between pin 3 (white/blue) and pin 12 (pink) and can be made in one of the products, in a wall socket, or by fitting a junction box. In

case of doubt the short circuit should be made on the ML cable regardless of the system setup.

Without the short circuit, the following faults can arise: All link audio functions work, but link video functions do not work.

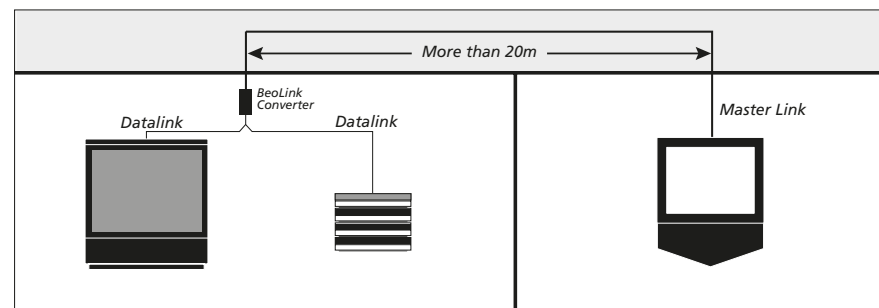

Do you experience any of the following with the Master Link system: The video jams (red bar on the shield), humming in the front loudspeakers, clicking in the rear loudspeakers when they are not in use, humming in all loudspeakers, or no communication between AV products?

If this is the case you should check whether the aerial is grounded. If not, we recommend creating a ground connection from here.

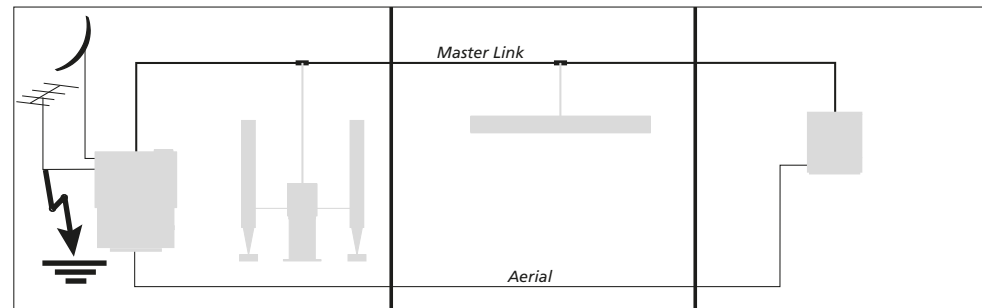

Simple Master Link measurements can be made either using a voltmeter or, preferably, an oscilloscope. All specifications are measured to ground using an oscilloscope. The Master Link cable specifications are seen [page 97](#).

Fault (a) No sound and no operation

Possible cause

The product is connected to mains and the stand-by LED is illuminated.

If this is OK, do the following:

- Measure data+ (pin 2) relative to ground.
- Measure data- (pin 1) relative to ground.
- When there is no transmission the reading should be between +/- 200 and 300 mV.
- When data is being transmitted it should read 0 V.

Reading using an oscilloscope. Measure the following:

No transmission

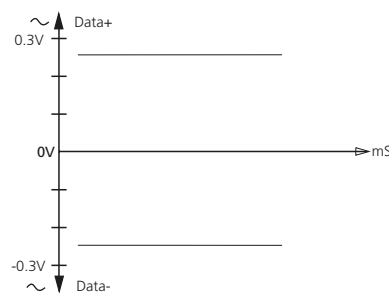

Transmission

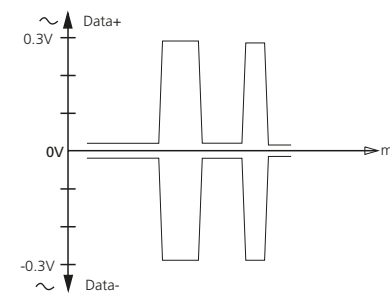

If data- and data+ are not as indicated in "No transmission" and are unable to transmit, there may be a fault in the main room BeoVision or BeoSound, as one of these supplies the voltage.

Note that with setups using the BeoLink Converter (ML/AAL converter) it is always the Master Link driver that supplies the voltage. If there are two Master Link drivers in the system, one will configure itself as supply master when connected.

The fault is found using the isolation method. If the fault is not in one of the Master Link drivers, there is another unit pulling data either low or high. There could also be a cable fault or connection fault. Data faults can also be read off in service mode, see section on service mode.

If the data is OK, proceed to reading the supply voltage, which must be as indicated under specifications. If the voltage is not OK, use the isolation method until you find the faulty equipment or faulty connection.

Fault (b) No sound but operation OK

Possible cause

Data and supply voltage are OK. Measure the signal level for pin 13 to 16 in relation to the specifications. If the signal level is OK, there is a fault with the link room product, possibly the converter box, cables or a connection fault.

Fault (c) Playing is at half volume

Possible cause

One of the balanced sound signals is missing.

Fault (d) No reaction when selecting a source from another product

Possible cause

No master Link 'sense' in a Master Link setup. Pin 3 does not send 8.5 to 15 V and the products are not 'sensed' by the Master in a Master Link Setup.

Solution: Mount a Maser link Junction Box, Part. No. 3232170 (black), 3132220 (white), 3375189 (large black) - as a built-in short circuit is made from Pin 3 ML sense (white/Blue) to Pin 12 (Pink).

Service mode

Products with a display have a service mode where Master Link faults can be read off. Note that the fault reading indicates that there is a system fault; this is not the same as saying there is a fault with the actual product where the fault message appears.

BeoLab 3500 and BeoVision Avant are examples of products with service mode. See service instructions for the individual product to find out how you can access service mode and the possibilities provided by service mode.

The example of service mode below is from BeoLab 3500.

ERROR 1: - Address configuration is impossible.

Fault with address configuration. No address was found, because there are too many units connected to the Master Link.

- Remove all products from the Master Link connection and reconnect them one by one other until the fault appears. Disconnect the product again.

ERROR 2: - Master Link data pulled low.

It is not possible to transmit on the Master Link because it is pulled low. This fault can arise if there is no Master Link driver circuit, or as a result of a physical short circuit in the Master Link or in the data receiver circuit.

- Remove the products from the Master Link connection one by one and see if it starts again.
- Reset the faulty product and check the connection (cable/plug) and signal path (data receiver circuit). See section on repair tips for a description of the data receiver circuit.

ERROR 3: - Master Link data pulled high.

It is not possible to transmit on the Master Link because it has been pulled high. This fault arises either because the pull-up resistance in the system has become too small, or as a result of a fault in the data receiver circuit.

- Remove the products from the Master Link connection one by one and see if it starts again.
- Reset the faulty product, check if the Master Link cable is too long, and check the signal path (the data receiver circuit). See section on repair tips for a description of the data receiver circuit.

ERROR 4: - Data collision on Master Link.

The data traffic on the Master Link has been unusually high, or a product is blocked and cannot receive data telegrams.

- Repeat the operating sequence.
- Remove the products from the Master Link connection one by one in order to find out which product is blocked. Reset the faulty product and check the Master Link connection (cable/plug) and signal paths (the amplifiers in the data receiver circuit).

See the service guide for individual products if you require further information.

Troubleshooting Power Link

Noise in speakers

- When long Power Link cables are used.
- When using BeoLab 4000, BeoLab 6000, BeoLab 8000 and older speakers in combination with BeoVision 11, BeoSystem 4, BeoVision Avant and newer TVs using VideoEngine A3.

Possible cause

Power Link cables pick up interference from other cables such as the mains cable.

BeoLab 4000 MK I, BeoLab 6000 and BeoLab 8000 have an unbalanced input in the Power Link connection, whereas newer speakers have a semi-balanced input making them more immune to picking up interference from other cables.

Solution

Decrease the interference by placing a Part No. 3376078 Semi-balanced PL Control Box in the setup. See [page 84](#).

The box must be placed as close to the speakers as possible!

The side with one Power Link sockets is the output.

The side with two Power Link sockets is the input (can be looped to next speaker inlet).

The small connector on the input side is for the power supply (EU adapter 12 Vac/230 mA).

Remember to use Power Link MK III cable or never Power Link Product Cables - Ø 5.0 mm /0.2" types. If it is a surround sound setup, you will need more than one box as the box only has one stereo Power Link input. (i.e.: one semi-balanced PL control box per speaker is needed).

Questions & Answers

Passive Infrastructure

- Question** Is it possible to crimp an RJ45 plug on existing Master Link or Power Link cables?
Answer No, it will give reliability problems over time.
- Question** Is it possible to crimp a RJ45 plug on Cat 7/Class F Network Link Installation Cable?
Answer No, RJ45 plugs can only be crimped on Network Link Product Cable. Network Link Installation Cable is intended for wall installation.
- Question** Do Bang & Olufsen accept use of other types than the preferred Cat 7/Class F cables and connectors in an installation?
Answer Bang & Olufsen cannot guarantee functionality with other types of cable/connector. An exception to this is LK LexCom Home/IHC net that also has been tested/approved to carry Master Link and Power Link connections. Cables and connectors from different manufactures must not be mixed in an installation.
- Question** Is it possible to see how much cable I have used in an installation?
Answer Yes, the installation cable is marked with forth going m (metre) indication. This way one can read the number when installation work starts, and then again when finished. The difference is the amount used for the installation.
- Question** Can I mount a connector on the Network Link Product Cable in the same way as I mount it on the Network Link Installation Cable?
Answer Yes. This way it is possible to make an extension cord. The parts needed are RJ45 socket for wall outlet (part number 7221710/7221711) with Network Link Installation Cable part number 6250027 (Ø 8 mm)), and RJ45 plug (part number 7221248) and Network Link Product Cable (part number 6250028 (Ø 6.0 mm / 0.24")).
- Question** Can I use Network Link Product Cable as installation cable?
Answer Yes. In situations where a thinner cable is required due to difficult installations (e.g. if two cables are to be pulled in one conduit), however used for Ethernet the max length to switch/router is 50 m (164 ft). For Master Link max 100 m (328 ft) can be Network Link Product Cable, the rest should be Network Link Installation Cable. See [page 79](#) and also [page 167](#) and [page 168](#).
- Question** Can Cat 7 cables be used for HDMI?
Answer The BeoLink installation concept can also be used to transfer HDMI. One or two Cat 7 cables must be reserved for each HDMI connections depending on technology used. Please note that additional active adapters are needed.
- Question** Can I connect two installation cables by soldering or using some sort of junction box?
Answer No, that is not possible. Cat cable must run unbroken between two plugs/sockets.
Two Network Link Installation cables may form an extension by the use of a Cable Distribution Frame. See also [page 79](#).
- Question** My customer want another design of wall plates than the one delivered from Bang & Olufsen. Can I use other designs?
Answer There is a number of 'Tyco Keystone' compatible wall plates available. Ask your local supplier of wall plates.
See also TIP in BeoWise: List of global wall outlets.
- Question** Can I use Cat 5e cables for installations?
Answer We recommend Cat 7 cables, as they are double shielded (immune to disturbance) and ensure high data transmission speed. This is especially important regarding video streaming. The recommendation is made to ensure a future-proof Bang & Olufsen solution, adapted to our future products. In most cases, if customers already have installations with Cat 5e or Cat 6 cables, there will probably be no problems in connecting Ethernet based products.
-

Active Infrastructure

- Question** What can I do if I lose contact with the web user interface on my NAS?
Answer After, for example, a power cut, the router might have given the NAS a new IP address. To avoid that IP addresses change over time, the router can be set to always assign the same IP address to a certain MAC address, see "Setting up the router connectivity" and "Subnetting", [page 56](#).
- Question** How can I check that the wireless connection is good enough to use?
Answer Set up a Bang & Olufsen recommended router *) and check with inSSIDer (on a laptop) on the spot where the product should be placed. When you measure the SNR (signal-to-noise ratio), the Signal must be 25 dBm higher than the noise. You also need to check with a frequency scanner (Wi-Spy) if there is interference from other sources, for example an alarm system. See "[Channel selection/planning](#)" on [page 61](#) for further information.
- Question** How can I make my customers aware that there is a risk that the wireless connection will change over time due to circumstances coming from outside?
Answer It is very important that you explain to customers that well-functioning wireless systems may develop problems at any given time for various reasons. If, for example, a neighbour installs an alarm system, this may influence the performance of the customer's wireless system. Especially if a non-Wi-Fi system or a wireless system which uses the same frequency as the customer's system is installed nearby, it will interfere with the performance of the customer's system. It is therefore only possible to guarantee the performance of the wireless system at the time of the installation.
- Question** I already use Wi-Fi for my MacBook with an Apple Airport, can I use this with my BeoSound 5 Encore for wireless connections?
Answer The Apple Airport is only working on 2.4 GHz and as the BeoSound 5 Encore work on 5 GHz, this will not work.
- Question** I already use Wi-Fi with an Apple Airport Extreme, can I use this with my BeoSound 5 or BeoSound 5 Encore for wireless connections?
Answer Bang & Olufsen recommend setting up a separate router when the router from the ISP is not sufficiently stable in securing the desired communication quality between the products in the setup*) to service the Bang & Olufsen products. However the Apple Airport Extreme is a dual band router and will work with BeoSound 5 and BeoSound 5 Encore in most situations. See also [page 52](#) and [page 53](#).
- Question** How can I access data on the NAS placed in the Bang & Olufsen Network Link subnet using my private PC.
Answer On some NAS there is 2 LAN connections. If the free LAN connector is connected to the router for the existing network, then a PC or MAC can access data on the NAS for music storage from the existing network.

*) See BeoWise, and open [3rd party products > Active Network Components > Cisco](#) to see recommended network products.

General Terms - definitions

Network Link

Network Link is the recent and structured wiring of video and audio products to a variety of sources and naturally also to the Internet by the help of Cat 7 cables (digital transmission). Cables and traffic are organised using a router or switch as the centre of a star topology. Bang & Olufsen recommend that all cable installations are made according to the Standards of Residential cabling. See also [page 168](#).

Master Link

Master Link is a link method used to link between former Bang & Olufsen products (video and audio) by the use of Master Link cables (analogue transmission).

Power Link

Power Link is a link method used to link between Bang & Olufsen products to convey audio signals to stand-alone loudspeakers using Power Link cables. (As some loudspeakers also have a link function in-built, that permits for remote controlling of the entire installation in the home.

Installation cable - horizontal cable

The in-wall cabling also named horizontal cabling between e.g. a technical room and other rooms in the building. The cables must be of the type Cat 7 to meet the requirements for conveying high quality video and audio data. The cables are typically connected in Patch Module and network Link Brackets in the Cable Distribution Frame/Cabinet/19" rack and lead to the wall plate in each room in the building.

Product Cable

The cable from the wall-plate to the product. The cables must be of the type Cat 7 to meet the requirements for conveying high quality video and audio data.

Patch cable

The - typically - short cable used in the Distribution Centre to connect between two units that can be routers/switches, source products and video and audio products. The cables must be of the type Cat 7 to meet the requirements for conveying high quality video and audio data.

Master Control Link

Obsolete link method used in older Bang & Olufsen products. See the Master Link Handbook that is found via BeoWise.

Cat

Cat standards are used in EU and many other countries worldwide whereas US and other countries use Class as denomination for the standards. The match between these are seen in the below table. As standards are continuously developed and improved especially due to improvements of modulation methods and consequently equipment and protocols, the stated bandwidth and capacities is continuously improved.

Important: In this handbook the TIA/EIA 568 B standard is used for colour coding of wires in the Cat connectors; see [page 169](#).



EU	US	Bandwidth freq.
Cat 5e	Class D	100 MHz
Cat 6	Class E	250 MHz
Cat 6a	Class EA	500 MHz

EU	US	Bandwidth freq.
Cat 7	* Class F	600 MHz
Cat 7a	* Class FA	1000 MHz

* Complying to Cat 7 requires special connectors

Cat 7/Class F installation concept

The Network Link concept is based on Cat 7/Class F double shielded Ethernet cable. This will eventually replace Master Link and Power Link cables. The Network Link concept ensures backward compatibility at the same time as preparing for the new digital world. Cat 7/Class F double shielded cable (S/FTP) has been selected because of its high bandwidth capability for future digital systems and for its resistance to noise when used to carry analogue audio signals instead of Power Link cables when used with, for example, BeoLab 5 and BeoLab 90 loudspeakers.

Note: In this BeoLink Handbook the term Cat 7/Class F will be used for such cables, as the actual cable complies to this standard and despite the applied connectors degrade the entire cable/connector solution to Cat 6a/Class EA. Cat 7 compliant connectors may later be added when desired.

In this handbook the **TIA/EIA 568 B** standard is used for colour coding of wire termination in the Cat connectors; see [page 169](#).

Connectors for wall plates are available in two versions. Choose a straight or angled Network Link connector depending on space behind the wall plate and placement of conduit.

The difference between these two connectors lies in the way the installation cable is mounted in the wall:

- Straight - where the cable goes directly into the back of the connector.
- Angled - where the cable goes into the side of the connector.

Face plates differ in every country. Please contact your local wall plate supplier for further information.

Recommendation on choice of installation cable

Bang & Olufsen recommend Network Link Installation Cable used for in-wall installation according to Standards for Residential cabling to avoid compromising the transferred signal due to the length of the cable run.

By using Network Link Product Cable as installation cable instead of Network Link Installation Cable it may be expected that the length of the cable run is reduced to 50 m / 164 ft. This is due to the Network Link Product Cable has lower signal strength (higher loss of signal) and a bigger transfer impedance (less noise immunity). The Network Link Product Cable has strained wires with less copper, and may differ in filler and distances between wire pairs, number of turns per unit length that all influence the cable performance. Also loss of potential on PoE will be influenced by long cables depending on quality. See also "Cable length" [page 79](#) and "Network Link cables" [page 99](#).

Cat cable - colour coding of wires

In this handbook the **TIA/EIA 568 B** standard is used for colour coding of wires in the Cat connectors.
Below the colour code of the wires are shown for both **TIA/EIA 568 B** and **TIA/EIA 568 A** are shown.

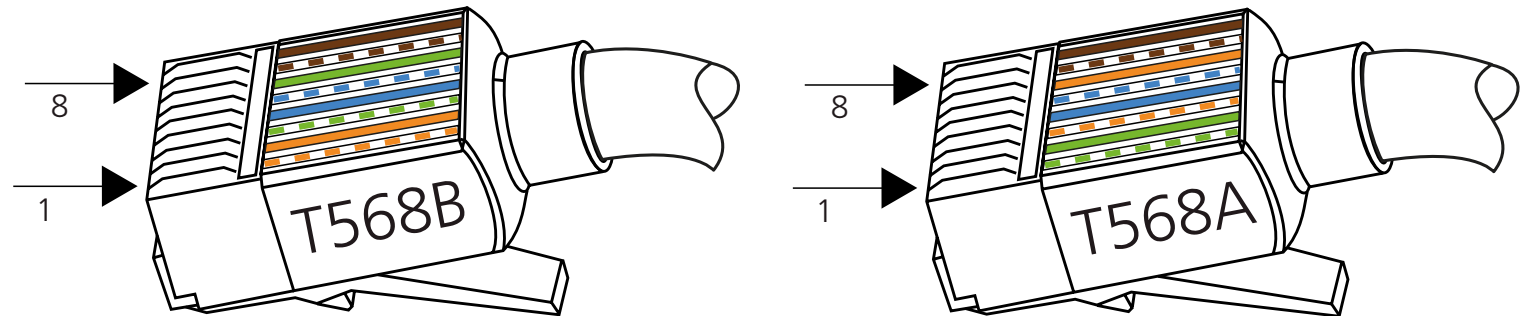

Option

Bang & Olufsen products are assigned an option setting to ensure the correct communication for the individual product with the remote control. See also [page 90](#).

Option	Function	Comment
Option 0	No IR reception	
Option 1	Two IR receivers in the same room	
Option 2	One IR receiver in the room	
Option 4 (Master Link products)	Is used in a (Main) room with two Audio or two TV products. One of the Master Link products must be in option 1/2 (a Master product) and the extra Master Link product must then be in Option 4; this is for ensuring the IR control, and the Master Link product must behave as a Link product.	Used with Master Link products
Option 4 (Network Link products)	Is used in a room with two Audio or two TV products. One of the Network Link products must be in option 1/2 and the extra Network Link product must then be in Option 4; this is for ensuring the IR control	Used with Network Link products
Option 5	Two IR receivers in the same link room (1 audio product and 1 video product)	Not used with Network Link
Option 6	One IR receiver in the link room	Not used with Network Link

In the Network Link setup the option setting is only relevant in relation to the IR addressing.

Glossary & Abbreviations

Term	Explanation
21-pin A/V cable/SCART	Standard cable for connecting a TV to different video sources, typically a video recorder. The cable is specified for RGB signal transmission.
3G	3 rd Generation technology for mobile communication
568 A & 568 B	See TIA/EIA 568 A & 568 B
802.11	See IEEE 802.11
AC	Short for Alternating Current
ADSL	Asymmetric Digital Subscriber Line
AP	Access point
Audio Aux Link	Audio Aux Link is the name of the 7-pin Datalink connection between the audio and video master in the main room. When this was launched it became possible to achieve a high degree of integration between audio and video systems and therefore A/V integration. In the latest generation of products, the Audio Aux Link connection has been replaced by Master Link.
AV	Audio/Video
A/V	Audio/Video
A/V setup	Setup using a connected audio and video system with two masters, which makes it possible to move the sound from one system to another.
A/V system	Audio/video system Integration of audio and video where there is only one master which manages all operations.
BeoLink	Sales description and overall description of Bang & Olufsen's method of distributing sound and images to other rooms in the home. BeoLink can be achieved in various ways depending on the products used in the setup: basically either using Network Link system or using the Master Link system.
BeoMaster	The control unit or audiomaster in component-based audio systems, e.g. BeoMaster 7000. For future products this designation will be replaced by BeoSound.
BeoSound	Common name for audio products, e.g. BeoSound Overture. Part of a new name structure for Bang & Olufsen products, in which all future audio products will be called BeoSound.
BeoVision	Common designation for TV and video systems, e.g. BeoVision MX 6000 and BeoVision Avant. Part of a new name structure for Bang & Olufsen products in which all future video products will be called BeoVision.
BV	Short for BeoVision
Cat 5e	Category 5e (enhanced). Cable type very common cable on non-Ethernet based installations
Cat 7	Category 7. Cable recommended for all future installations in a Network Link setup
Cat 6a	Category 6a (enhanced). Cable type very common cable on Ethernet based installations
Cat 7/Class F	Category 7. Cable recommended for all future installations in a Network Link setup. An Ethernet cable with braided shielding added for the individual wire pairs and the cable as a whole. Besides the foil shield, the twisting of the pairs and number of turns per inch causes RF shielding and protects from crosstalk. The Cat 7 cable standard allow 10 Gigabit Ethernet over 100 m of copper cabling. See page 79
CL2P	Class 2 Plenum cable - for in-wall installation in plenum, riser and general spacer
Compatibility	Ability to combine products from different seasons and with different interfaces.

Connect to	Value to state when setting up Network Link products: The value is the Serial Number of the product from which the sound can be distributed to the present product.
Control box	Box that controls data and signals, e.g. in BeoLink Active.
Datalink cable	7-pin datalink cable used for the Audio Aux Link connection between audio and video systems in the main room. In the latest generation of products the cable is replaced by the Master Link cable.
DFS	Dynamic Frequency Selection; name of channels in the 5 GHz U-NII frequency spectrum; the channels are not free but can be used with certain restrictions
DHCP	The Dynamic Host Configuration Protocol (DHCP) is a computer networking protocol used by hosts (DHCP clients) to retrieve IP address assignments and other configuration information
DNS	Domain Name System (name server on the Internet)
DSL	Digital Subscriber Line
Gbps	Gigabit per second (Gbit/s or Gb/s or Gbps)
HSDPA	High Speed Downlink Packet Access
IEEE 802.11	A family of networking standards (which are marketed under the brand name Wi-Fi), specifying carrier frequency and throughput in WLAN. See available channels, according to national regulations page 60 .
802.11a	Carrier frequency: 5 GHz, data rate up to 54 Mb/s, non overlapping channels: 24 (20 MHz ch.), 12 (40 MHz ch.) country dependant.
802.11b	Carrier frequency: 2.4 GHz, data rate up to 11 Mb/s, non overlapping channels: 3
802.11g	Carrier frequency: 2.4 GHz, data rate up to 54 Mb/s, non overlapping channels: 3
802.11n	Carrier frequency: 2.4 GHz non overlapping channels: 3 (20 MHz ch.), or 5 GHz, data rate up to 300 Mb/s, non overlapping channels: 24 (20 MHz ch.), 12 (40 MHz ch.) country dependant.
802.11ac	Carrier frequency: 5 GHz, data rate up to 1 Gb/s., non overlapping channels: non overlapping channels: 24 (20 MHz ch.), 12 (40 MHz ch.), 6 (80 MHz ch.), 3 (160 MHz ch.) country dependant.
IoT	Internet over Satellite
IP	Internet Protocol
IR receiver	IR receivers are built into video, audio and link products and receive infrared signals from a remote control. This enables the products to be operated using a BeoRemote One or Beo4.
ISP	Internet Service Provider
kbps	Kilobit per second (kbit/s or kb/s or kbps)
kBps	Kilobyte per second (kB/s or kBps)
LAN	Local Area Network Ethernet
Link room	Designation for the ML room(s) in the house where kits or products are installed that facilitate distribution from a main room system.
Link room kit	Kits designed specifically for link rooms, e.g. BeoLink Active and BeoLink Video.
Link room product	Products designed specifically for link rooms, e.g. BeoLab 3500.

MAC address	Media Access Control address is a unique identifier assigned to most network adapters or network interface cards (NICs) by the manufacturer for identification, and used in the Media Access Control protocol sub-layer.
Main room	Designation for the room(s) in the house where the central system is located, and from where any distribution to other rooms takes place. The main room can contain an audio, a video or an A/V system. There are basically two types of main room: - One room setups: audio and video systems positioned in the same room - Two room setups: audio and video systems in two different rooms.
Main room products	Product(s) that can be drivers in a BeoLink system, e.g. BeoVision and BeoSound.
Master Control Link (MCL)	Master Control Link is the name of the connection used up until today between the main room and link room. Gradually replaced from the 1994/95 season by the Master Link connection on launch of new products.
Master Link (ML)	Bang & Olufsen's new system connection. Master Link is the name of the connection between the audio and video system in the main room. See section "General Terms - definitions" page 167 .
Master Link driver	BeoSound and BeoVision with Master Link socket. A Master Link driver is always required in a Master Link setup.
Master Link product	All products with a Master Link socket.
ML	Short for Master Link
MoCA	Multimedia over Coax Alliance
NAS	Network Attached Storage
Network Link	Bang & Olufsen Network for Ethernet products
NL	Short for Network Link
One-way remote control	A remote control which operates the products by sending a command to them without requiring a response back (e.g. BeoRemote One and Beo4).
Option programming	Option programming is performed using a Bang & Olufsen remote control. The products that need to be option programmed must be on stand-by. Using the option programming you tell the products what type of setup they are part of so that they can be operated and function optimally.
PL	Short for Power Link
QoS	Quality of Service important for e.g. VoIP
Power Link (PL)	Bang & Olufsen connection between a master and active Bang & Olufsen loudspeakers, with signals at line level. There are two versions of the cable: one type with both line signals for display readout (8-pin) and a thinner type without data signals for display readout (4-pin) The latter cannot be used for loudspeakers with a display.
Product Configuration Guide (PCG)	A PC-based tool that makes it possible to compose the desired product setup and provides answers to questions regarding compatibility, setups, options, remote controls, special considerations etc., so that a system in the customer's home can be dimensioned optimally and be free from errors.
RJ45	A registered jack connector and wiring pattern used for connection of a high-speed modem to a telephone network using a keyed 8P8C modular connector

Share speakers	Value to state when setting up Network Link products: No means that the speakers will not be shared for listening to sound from other products. Yes means that the loudspeakers with the product will play sound from other products when they are On.
S/STP	Screen Shielded Twisted Pair normal for Cat 7
SSID	Service set identifier Name/ID on wireless access point
STP	Shielded Twisted Pair (Cat 5e, Cat 6, Cat 6A or Cat 7)
Subnet	Subnetwork
TCP	Transport Control Protocol (with acknowledge from receiver)
TIA/EIA 568 A & 568 B	Standard used for the wire colour code in Cat cables. In this handbook TIA/EIA 568 B is used.
T568A	Wiring pattern for 8 wire Ethernet cable The specification for Category 5 cable was defined in ANSI/TIA/EIA-568-A, with clarification in TSB-95. These documents specified performance characteristics and test requirements for frequencies of up to 100 MHz. Cable types, connector types and cabling topologies are defined by TIA/EIA-568-B. The cable is terminated in either the T568A scheme or the T568B scheme. Canada and Australia use the T568A standard, and the United States commonly uses T568B scheme. The two schemes work equally well and may be mixed in an installation so long as the same scheme is used on both ends of each cable. Nearly always, 8P8C modular connectors, often referred to as RJ45, are used for connecting category 5 cable.
T568B	See T568A above.
Tx/Rx	Transmit/Receive
UDP	User Datagram Protocol (without acknowledge from receiver)
UHD	Ultra High Definition
UPnP	Universal Plug and Play (protocol)
URL	Uniform Resource Locator
UTP	Un-shielded Twisted Pair (common on Cat 5)
WAN	Wide Area Network Internet
WEP	Wired Equivalent Privacy not recommended not strong encryption (64/128-bit)
Wi-Fi	Wireless Fidelity is a trademark of the Wi-Fi Alliance that manufacturers may use to brand certified products that belong to a class of wireless local area network (WLAN) devices based on the IEEE 802.11 standards
WiMAX	Worldwide Interoperability for Microwave Access
Wireless standards	See IEEE 802.11
WPA/WPA2	Wi-Fi Protected Access. This method is recommended instead of WEP.
WPS	Wi-Fi Protected Setup. Wi-Fi Protected Setup (WPS) is a standard for easy and secure establishment of a wireless home network, created by the Wi-Fi Alliance

Index

Symbols

2.4 GHz band	58
5 GHz band	58
5 GHz channel pattern	
- countrywise	60
19" rack - brackets	136
19" racks	82

A

Abbreviations & Glossary	171
Access Point	65
Access Point placement	69
Access Points	
- Additional	65
Active infrastructure	52
Active Infrastructure - Q & A	166
Adaptor	
- Adaptor cables - IR-blaster	124
- Mini Jack Stereo to 7 pin DIN	117
- Mini Jack Stereo to RJ45	115
- Mini Jack to 2 RCA female	116
- Power Link	110
- Power Link - DIN (female) to DIN	
(female)	113
- Power Link - RCA male to DIN	114
- Power Link - RCA male to RJ45	114
- Power Link - RJ45 to DIN (female)	113
- RCA female to DIN	115, 116
- RCA male to DIN	114
- SCART to AV	128
Additional Access Points	65
Advanced Ethernet cable tester	95

Always On	
- BeoLab Transmitter 1	32, 60
AP - Access Point	69
AP - channel planning	61
App	
- BeoLink	50
- BeoMusic	50
- BeoRemote	50
- BeoTool	158
Apps	50
Assembly of connectores - sockets (jack-	
ets) and plugs	141
Assembly of Master Link plug	147
Assembly of Power Link cables - Junction	
Box - 8, 6 or 5 wire	152
Assembly of RJ45 connector	97
Assembly of RJ45 connector (socket/jack-	
ect) - for wall outlet	141
Assembly of RJ45 plug	144, 150, 152
Assembly of RJ45 plug for Cat cable	144
Atlona	
- IR cables	125
- optocoupler IR cables	125
Audio Distribution	35
Auto channel	58
Auto Channel	57
AV to SCART adaptor	128
B	
Balanced to non balanced	
- converter box	140
- speakers	84
- troubleshooting	164
Bang & Olufsen Network setup	53
Base - Outdoor socket	131
Basic Network setup	52

Basic Network setup - Router settings	55
Bend radius	77
Beo4	
- constant Link mode	92
BeoLab 90	
- IR-eye without Autocontrast	123
BeoLab 3500	13
BeoLab Receiver 1	34
BeoLab Transmitter 1	32
- Always on	60
- Always On	32
BeoLink	4
BeoLink Active	14
BeoLink Active, BeoLink Passive - IR-	
receiver	120
BeoLink App	47, 50
BeoLink Converter (ML/AAL)	17
BeoLink Converter NL/ML	26
BeoLink Converter NL/ML - IR-receiver	119
BeoLink Gateway	28, 48
- advantages	49
- Connections	48
BeoLink Passive	15, 18, 19
BeoMusic App	39, 50
- in landscape view	40
- in portrait view	39
- Limitations	43
- Master Link - Delay / Echo	45
- Power for ML	45
- Precautions	41
BeoRemote App	50
BeoSystem 3 - IR-eye with Autocontrast ...	
121	
BeoSystem 3 - IR-eye without Autocon-	
trast	123

BeoSystem 4 - IR-eye with Autocontrast ...	
121	
BeoSystem 4 - IR-eye without Autocon-	
trast	122
BeoTool	158
B&O Recommended Router	52
- Setting up	55
- Wireless setup	57
Borrow	40
Brackets for 19" racks	136
Broadcast	
- Network Delay setting	41
Broadcast	
- Network Delay value	41
C	
Cabinets	82
Cable	
- Bend radius	77
- Fastening	76
- Length	79
- Noise reduction	78
- Numbering	77
- Outdoor installation	76
- Pulling	76
- Separation distance	76
- Shielding	77
- Tying	76
Cable Distribution Frame	83
Cable handling	76
Cable management	76
Cable Managers	139
Cables, Master Link	97
Cables, Power Link	101
Cable tester - ML/PL	96
Cat 5e	167

-
- Cat 6 167
 - Cat 6a 167
 - Cat 7/Class F installation concept - definition 168
 - Cat cable
 - cable length 79
 - colour coding of wires 169
 - Cat cable - RJ45 plug - assembly 144
 - Cat - definition 167
 - Channel change
 - Network Delay 41
 - Channel planning
 - Tools 61
 - Channel Planning 73
 - Channel planning - AP 61
 - Channel selection 58
 - Channel selection - AP 61
 - Circular - Flush-fit kit for
 - ML transceiver - in-wall 131
 - Class F/Cat 7 installation concept - definition 168
 - Coax plug 126
 - Colour coding of wires - Cat cable 169
 - Connecting Master Link cables 89
 - Connectors 126
 - Connectors - jacks - plugs - sockets ... 126
 - Constant Link mode 92
 - Content of the source
 - BeoMusic App 39
 - Coverage and connections 71
 - Crimp RJ45
 - on ML and PL cable 165
 - on Network Link Instalaltion
 - Cable 165
 - Crimp tool for RJ45 plug 93
 - Crimp tool for RJ45 socket 93
 - Crimp tool - Master Link 94
 - D**
 - Default Gateway 56
 - Delay
 - Sound stream 41
 - Video stream 41
 - Delay Box NL/ML 27
 - DHCP Server 57
 - DIN (2) to Mini Jack -
 - Power Link splitter - 2.5 m 112
 - DIN 8-pin - Wall socket 130
 - DIN (female) to DIN (female) -
 - Power Link Adaptor 113
 - DIN (female) to RJ45 -
 - Power Link Adaptor 113
 - DIN plug (male), 7-pin 126
 - DIN socket (female) 8-pin 126
 - DIN to RCA female - adaptor 115, 116
 - DIN to RCA male - adaptor 114
 - Distance
 - 5 GHz transmitters 59
 - Distribution Frame 83
 - Distributor 89
 - Distributor - Master Link 135
 - DNS 65
 - Drop outs 58
 - E**
 - Echo 41
 - Expand 40
 - Extending cables 76
 - Extension of LAN using Powerline 66
 - F**
 - Fault finding and troubleshooting on
 - Wi-Fi 73
 - F-connector insert 126, 127
 - Flush-fit kit for ML transceiver -
 - round - in-wall 131
 - FUGA - Network Link Wall Plate 137
 - Future-proof 38
 - G**
 - Galvanic isolator 140
 - General Terms - definitions 167
 - Glossary & Abbreviations 141
 - Grounding - rules 81
 - H**
 - Handling cables 76
 - Home Automation 38
 - experiences 47
 - suppliers 49
 - Horizontal cable - Installation cable - definition 167
 - I**
 - inSSIDer 61
 - Installation accessories 130
 - Installation cable - horizontal cable - definition 167
 - Installation Cable - Network Link -
 - in cable reels - for self mounting, Ø 8.0 mm, S/FTP, Cat 7/Class F, 8 wires + braided shield 99
 - Installation examples with bill of material 86
 - In-wall - Flush-fit kit for
 - ML transceiver - round 131
 - IR-blaster
 - Adaptor cables 124
 - PUC 51
 - IR-blaster cables 124
 - IR cables
 - Atlona 125
 - Atlona optocoupler 125
 - IR control cable
 - PUC 51
 - IR-eye with Autocontrast 121
 - BeoSystem 3 121
 - BeoSystem 4 121
 - IR-eye without Autocontrast 122
 - BeoLab 90 123
 - BeoSystem 3 123
 - BeoSystem 4 122
 - IR-receiver
 - BeoLink Active, BeoLink Passive .. 120
 - BeoLink Converter NL/ML 119
 - IR-receiver cable - Low-capacity 120
 - IR-receiver installation 87
 - IR-receiver - placement 88
 - IR-receiver with control buttons 119
 - ISP - interfaces 74
 - ISP router 52
 - ISP Router - settings 54
 - J**
 - Jacks 126
 - Join 40
 - Junction Box 89
 - Junction Box - assembly of Power Link
 - cables - 8, 6 or 5 wire 152
 - Junction boxes 132
 - Junction Box - Master Link 133
 - Junction Box - Power Link 132
 - L**
 - LAN 172
 - LAN extension using Powerline 66
-

- Length of cable 79
- Link, Network 20
- Link, Power 30
- Link room 172
- Lip-synch 41
- Low-capacity IR-receiver cable 120
- M**
- Master 97
- Master Control Link - definition 167
- Master Link
- cable connections 89
 - Crimp tool 94
 - definition 167
 - Distributor 89, 135
 - Junction Box 89, 133
 - Patch Modules 136
 - plug 126
 - socket - wall outlet 132
 - Wall socket 130
- Master Link Cable
- cable tester 96
 - in cable reels 98
 - ML to ML 97
 - ML to RJ45 98
 - Troubleshooting 160
 - wiring 97
- Master Link Cable - wiring
- obsolet 98
- Master Link Delay box 19
- Master Link - Delay / Echo 45
- Master Link Gateway 18
- Meeter marking on cable 165
- Mini Jack Stereo to 7 pin DIN - adaptor
- source in to AUX 117
- Mini Jack Stereo to RJ45 - adaptor
- source-in to BeoPlay S8, BL14 115
- Mini Jack to 2 DIN - Ø 3.5 mm;
- 2.5 m - Power Link Splitter 112
- Mini Jack to 2 RCA female adaptor ... 116
- ML/MCL Converter 16
- ML/PL cable tester 96
- Multiroom 38
- BeoMusic App 39
- Multiroom Scenarios 45
- N**
- Nanoperm coil 140
- Network Delay
- channel change 41
 - LAN 41
 - WLAN 41
- Network Link 20
- cable length 79
 - definition 167
 - Installation Cable in cable reels;
 - Ø 8.0 mm 99
 - Plenum Cable in cable reels;
 - Ø 6.55 mm 100
 - Product Cable in cable reels;
 - Ø 6.0 mm 100
 - Product Cable - RJ45 to RJ45 99
 - Product Cable with plugs,
 - Ø 6.0 mm 99
 - product configuration 41
 - Wall Mount 138
 - Wall Plate 138
 - Wall Plate, FUGA 137
 - Wall Plate - UK 138
- NL/ML Delay Box 27
- Noise reduction - Power Link 78
- Non balanced to balanced
- converter box 140
 - speakers 84
 - troubleshooting 164
- Numbering of cables and connectors .. 77
- O**
- Obsolete Power Link cables 101
- Obsolete Power Link Product Cable
- with plugs, Ø 2.5 mm 109
- Obsolete Power Link Product Cable
- with plugs, Ø 3.5 mm 107
- Obsolete Power Link Product Cable
- with plugs, Ø 5.5 mm 108
- One remote 38
- One-remote 50
- One-touch operation 38
- Option
- definition 170
 - programming 90
 - setting 90
 - Special setups 91
- Original cables and connectors 78
- Other cables 110
- Outdoor installation - cables 76
- Outdoor socket - base 131
- P**
- Passive Infrastructure 76
- Passive Infrastructure - Q & A 165
- Password 68
- Patch cable - definition 167
- Patch Module - Master Link 7, 83
- Patch Module - Power Link 83
- Patch Modules 136
- Peripheral Unit Control 51
- Placement of Access Point 69
- Placing the IR-receiver 88
- PL cable types and length 84
- Plenum Cable - Network Link - in cable
- reels - for self mounting, Ø 6.55 mm,
 - S/FTP, Cat 6/Class E, 8 wires + braided
 - shield 100
- Plug - Coax plug 126
- Plug - DIN plug, 7-pin, male 126
- Plug - ML plug 126
- Plugs 126
- Port forwarding 64
- Positioning of IR-receiver 88
- Power for ML 45
- Powerline 66
- Power Link 30
- Adaptor DIN (female) to
 - DIN (female) 113
 - Adaptor RJ45 to DIN (female) 113
 - adaptors 110
 - Assembly of RJ45 plug for
 - Ø 2.5 mm cable -
 - finger mounting 150
 - cable - general information 101
 - cables 101
 - cable tester 96
 - definition 167
 - finger mounting of RJ45 plug for
 - Ø 2.5 mm cable 150
 - Installation Cable in cable reels -
 - for self mounting, Ø 5.0 mm 103
 - Junction Box 132
 - Junction Box for assembly of
 - cables with 8, 6 or 5 wires 152
 - Obsolete cables 101
 - Patch Modules 136

- Product Cable in cable reels - for self mounting, Ø 2.5 mm 106
- Product Cable Ø 2.5 mm - DIN to DIN 105
- Product Cable Ø 2.5 mm - DIN to RJ45 105
- Product Cable Ø 2.5 mm - RJ45 to RJ45 106
- Product Cable Ø 3.5 mm - DIN to DIN 104
- Product Cable Ø 3.5 mm - DIN to RJ45 104
- Product Cable Ø 5.0 mm - DIN to DIN 102
- Product Cable Ø 5.0 mm - DIN to RJ45 102
- Product Cable Ø 5.0 mm - RJ45 to RJ45 103
- Product Cable with plugs, Ø 2.5 mm, FTP, 4 wires + braided shield 105
- Product Cable with plugs, Ø 3.5 mm, STP/UTP, 6 wires + braided shield 104
- Product Cable with plugs, Ø 3.5 mm, STP/UTP, 6 wires + braided shield; pin 3 and pin 7 are short circuit 104
- Product Cable with plugs, Ø 5.0 mm, S/FTP, 6 wires + braided shield 102
- Splitter Cable 110, 111
- Splitter - Mini Jack to 2 DIN - Ø 3.5 mm; 2.5 m 112
- Wireless (WPL) 31
- Power Link Adaptor
 - DIN (female) to DIN (female) 113
 - Mini Jack Stereo to RJ45 115
 - RCA female to DIN 115
 - RCA male to DIN 114
 - RCA male to RJ45 114
 - RJ45 to DIN (female) 113
- Power Link Splitter
 - Box 3 x RJ45 female 112
 - Mini Jack to 2 DIN 112
- Power Link Splitter Cable
 - for subwoofers 111
- Product Cable
 - definition 167
 - Network Link - in cable reels - for self mounting, Ø 6.0 mm, S/FTP, Cat 7/Class F, 8 wires + braided shield 100
 - Network Link - with plugs, Ø 6.0 mm, S/FTP, Cat 7/Class F, 8 wires + braided shield 99
 - Power Link - with plugs, Ø 2.5 mm, FTP, 4 wires + braided shield 105
 - Power Link - with plugs, Ø 5.0 mm, S/FTP, 6 wires + braided shield 102
 - SCART to SCART 127
- Product cable - SCART to SCART 127
- Product configuration
 - Network Link products 41
- Product menu
 - BeoMusic App 39
- PUC 51
- Pulling cables 76
- Q
 - Q & A 165
 - Q & A - Active Infrastructure 166
 - Q & A - Passive Infrastructure 166
 - Q & A - Passive Infrastructure 165
 - Q&A Passive Infrastructure 90
 - QoS 42
 - Quality of Services 42
 - Questions & Answers 165
- R
 - RCA female to 5 pin DIN - adaptor 117
 - RCA female to DIN - adaptor 115, 116
 - RCA male to DIN - adaptor 114
 - RCA male to RJ45
 - Power Link adaptor 114
 - Power Link Adaptor 114
 - Receiver
 - BeoLab Receiver 1 34
 - Remote control 47
 - One-remote 50
 - RJ45 connector (socket/jackect) - for wall outlet - assembly 141
 - RJ45 jacks/socket
 - for wall outlet and brackets 129
 - RJ45 plug - Crimp tool 93
 - RJ45 plug for Cat cable - assembly 144
 - RJ45 plug for Ø 2.5 mm PL cable 129
 - RJ45 plug w. screen for Cat cable 129
 - RJ45 socket
 - for wall outlet and brackets 129
 - RJ45 socket - Crimp tool 93
 - RJ45 to DIN (female) - Power Link Adaptor 113
 - Round - Flush-fit kit for ML transceiver - in-wall 131
- Rules for Grounding 81
- S
 - SCART
 - 21-pin-out 127
 - SCART to AV adaptor 128
 - SCART to SCART product cable .. 127
 - Separation distance 76
 - Settings in the ISP Router 54
 - Setting up the Router - Basic Network setup 55
 - Setting up Wi-Spy 63
 - Set up a subnet 57
 - Shielding 77
 - Signal noise 69
 - signal/noise ratio 69
 - Signal strength 70
 - Simple Ethernet cable tester 95
 - Site Survey 69
 - Site survey (Wi-Spy) 63
 - SNR 42, 69, 73, 166
 - Sockets 126
 - Sound distribution 38
 - Sound drop-outs 41
 - Sound stream
 - delay 41
 - Sources
 - BeoMusic App 39
 - S/P-DIF cables 118
 - Splitter 85
 - Splitter Cable
 - Power Link for subwoofers 111
 - Power Link - Mini Jack to 2 DIN - Ø 3.5 mm; 2.5 m 112
 - Splitter Cable - Power Link
 - subwoofers 111

Subnetting	56	Wired connection	
T		- Network Link Delay	41
Technical room	82	Wireless	
Test tools	95	- 2.4 GHz band	58
Tools	166	- 5 GHz band	58
- channel planning	61	- Power Link	31
Transmitter		Wireless connection	
- BeoLab Transmitter 1	32	- Network Link Delay	41
Troubleshooting	154	Wireless Limitations	68
- HDMI networks	159	Wireless network	
- LAN networks	154	- reasons to weakness	41
- Master Link network	160	Wireless setup	57
- Network Link networks	154	Wireless survey, planning & installation	72
Troubleshooting Master Link	160	Wi-Spy	
U		- DBx	62
Unoriginal cables and connectors	78	- setting up	63
V		- site survey	63
Various	140		
Video Distribution	35		
- coax cable	35		
- HDMI matrix	36, 37		
Video stream			
- delay	41		
W			
Wall Mount - Network Link	138		
Wall outlet - Master Link socket	132		
Wall Plate	137		
Network Link	138		
- Network Link, FUGA	137		
- Network Link - UK	138		
Wall socket, DIN 8-pin	130		
Wall socket, Master Link socket	130		
WiFi Analyzer	61		

Table of Contents	
Navigation in this handbook	2
Navigation TIP.....	2
How to use this handbook	3
Main sections	3
Active Infrastructure.....	3
Passive Infrastructure	3
Supporting handbook sections.....	3
Index	3
Omissions / Master Link Handbook	3
BeoLink - an overall introduction	4
Provided advantages.....	5
Control of products	5
One-remote - all at the hand.....	5
Magic, surprise, tranquillity, believable	6
Apps.....	6
Master Link - an overall description	7
Principles of a Master Link setup:.....	7
Master Link Scenarios	8
<i>ML scenario 1</i>	
- <i>Audio only</i>	8
<i>ML scenario 2</i>	
- <i>Video only</i>	9
<i>ML scenario 3</i>	
- <i>Video and Audio in main room</i>	10
<i>ML scenario 4</i>	
- <i>Video and Audio in main room and link rooms</i>	11
<i>ML scenario 5</i>	
- <i>Audio in main room (living room) and video in main room (bedroom)</i>	12
Master Link - link products.....	13
<i>BeoLab 3500</i>	13
<i>BeoLink Active</i>	14
<i>BeoLink Passive</i>	15
<i>ML/ML Converter</i>	16
<i>BeoLink Converter (ML/AAL)</i>	17
<i>Master Link Gateway</i>	18
<i>Master Link Delay Box</i>	19
Network Link - an overall description	20
Network Link Scenarios.....	21
<i>NL scenario 1</i>	
- <i>Network Link products only</i>	21
<i>NL scenario 2</i>	
- <i>Network Link TV and Master Link audio</i>	22
<i>NL scenario 3</i>	
- <i>Echo free distribution of audio</i>	23
<i>NL scenario 4</i>	
- <i>BeoLink Converter connected to loudspeakers - in living room. Echo free distribution of audio</i>	24
<i>NL scenario 5</i>	
- <i>Master Link TV in main room and mix of NL and ML products</i>	25
Network Link - link products	26
<i>BeoLink Converter NL/ML</i>	26
<i>NL/ML Delay Box</i>	27
<i>BeoLink Gateway</i>	28
<i>ML Power Box</i>	29
Power Link - an overall description	30
Power Link - products	30
Setup.....	30

Wireless Power Link	31	PUC.....	51
Wireless Power Link - link products	32	IR-blaster/IR control cable.....	51
<i>BeoLab Transmitter 1</i>	32	Active Infrastructure - an overall description.....	52
<i>BeoLab Receiver 1</i>	34	Basic Network setup	52
Audio Distribution	35	Bang & Olufsen Network setup	53
Video Distribution.....	35	ISP Router settings.....	54
<i>Video distribution - distribution products</i>	37	<i>Bridge mode</i>	54
BeoLink Multiroom	38	<i>Non-bridge mode</i>	54
More than just Multiroom.....	38	Setting up the B&O Recommended Router	55
BeoMusic App for BeoLink Multiroom.....	39	<i>Accessing the Web interface</i>	55
<i>App in portrait mode</i>	39	<i>Setting up the router connectivity</i>	56
<i>App in landscape mode</i>	40	<i>Wireless setup</i>	57
Product understanding.....	41	<i>Channel selection</i>	58
<i>Precautions</i>	41	<i>Wireless setting up conditions</i>	59
<i>Good installation practice</i>	42	<i>Automatic or manual channel selection</i>	61
<i>Limitations</i>	43	<i>Channel selection/planning</i>	61
<i>Master Link - Delay / Echo</i>	45	<i>Tools</i>	61
<i>Power for ML</i>	45	<i>How to use Wi-Spy</i>	63
<i>Home Automation</i>	45	Port forwarding	64
BeoLink Multiroom Scenarios.....	45	<i>Reach devices from outside the network</i>	64
BeoLink Multiroom scenario 2-2-0	46	Additional Access Points	65
<i>Settings in products</i>	46	<i>Setup the router as an access point</i>	65
<i>Note</i>	46	Extension of LAN using Powerline	66
BeoLink SmartHome - an overall description	47	<i>dLAN® 500 duo, Starter kit</i>	66
Remote control and operation panels.....	47	<i>dLAN® 650 triple+, Starter kit</i>	66
The BeoLink Gateway	48	<i>dLAN® 500 WiFi, Starter kit</i>	67
<i>Connections</i>	48	<i>dLAN® 500 WiFi, Single unit</i>	67
New advantages of the BeoLink Gateway	49	<i>dLAN® 500 AV Wireless+, Starter kit</i>	67
<i>Home Automation - suppliers</i>	49	Nice to know - about wireless.....	68
One-remote	50	<i>Router login password</i>	68
		<i>Wireless Limitations</i>	68
		<i>Wireless access point/router placement</i>	69
		Coverage and connections in local access network	71

Wireless survey, planning & installation	72	<i>PL cable types and cable length</i>	85
<i>Questionnaire to the customer</i>	72	<i>Non balanced speakers</i>	85
<i>Measurement in the customer's home</i>	72	<i>Splitter</i>	86
<i>Configuration and installation of Wireless infrastructure units</i>	72	<i>Installation examples with bill of material</i>	87
<i>Fault finding and troubleshooting on Wi-Fi</i>	73	<i>IR-receiver installation</i>	88
ISP - interfaces	74	<i>Positioning of IR-receiver</i>	89
<i>Dial-up modem</i>	74	<i>Master Link cable connections</i>	90
<i>MoCA/Cable Internet</i>	74	Option programming	91
<i>WiMAX</i>	74	<i>Setups</i>	91
<i>Cellular Broadband (3G/HSDPA/4G)</i>	75	<i>Special setups</i>	92
<i>Fibre</i>	75	Beo4 in constant Link mode	93
<i>DSL</i>	75	Tools	94
<i>Satellite</i>	75	<i>Crimp tool for RJ45 plug (Cat cable)</i>	94
Passive Infrastructure	76	<i>Crimp tool for RJ45 socket (jacket) - wall outlet</i>	94
Cable management/handling	76	<i>Master Link Cable fitting tools</i>	94
<i>Cable - tying</i>	76	<i>Master Link Crimp tool</i>	95
<i>Cable - fastening</i>	76	Test tools	96
<i>Separation distance</i>	76	<i>Simple Ethernet cable tester</i>	96
<i>Pulling cables</i>	76	<i>Advanced Ethernet cable tester</i>	96
<i>Outdoor installation</i>	76	<i>HDMI tester</i>	96
<i>Extending cables</i>	76	<i>ML/PL cable tester</i>	97
<i>Numbering of cables and connectors</i>	77	Master Link cables	98
<i>Bend radius</i>	77	<i>Master Link Cable - wiring</i>	98
<i>Shielding</i>	77	<i>Master Link Cable - ML to ML</i>	98
<i>Noise reduction - Power Link</i>	78	<i>Master Link Cable - ML to RJ45</i>	99
<i>Original cables and connectors</i>	78	<i>Master Link Cable in cable reels - for installation and self mounting</i>	99
<i>Cable length</i>	79	Network Link cables	100
Installation principles	81	<i>Network Link Product Cable with plugs, Ø 6.0 mm / 0.24", S/FTP, Cat 7/</i>	
<i>Grounding - rules for Grounding</i>	81	<i>Class F, 8 wires + braided shield</i>	100
<i>Technical room</i>	83	<i>Network Link Installation Cable in cable reels - for self mounting, Ø 8.0</i>	
<i>Cabinets/19" racks</i>	83	<i>mm / 0.31", S/FTP, Cat 7/Class F, 8 wires + braided shield - solid wires</i>	
<i>Patch Modules</i>	84	<i>AWG23</i>	100
<i>Cable Distribution Frame</i>	84		

Network Link Product Cable in cable reels - for self mounting, Ø 6.0 mm / 0.24", S/FTP, Cat 7/Class F, 8 wires + braided shield - strained wires AWG26 101	Power Link Adaptor - RCA male to DIN..... 115
Network Link Plenum Cable in cable reels - for self mounting, Ø 6.55 mm / 0.26", S/FTP, Cat 6/Class E, 8 wires + braided shield 101	Power Link Adaptor - RCA male to RJ45 115
Power Link cables 102	Power Link Adaptor - RCA female to DIN..... 116
Power Link cable - general information 102	Power Link Adaptor - Mini Jack Stereo to RJ45 116
Obsolete Power Link cables..... 102	Various Adaptors 117
Power Link Product Cable with plugs, Ø 5.0 mm / 0.2", S/FTP, 6 wires + braided shield..... 103	Mini Jack to 2 RCA female -adaptor - Ø 3.5 mm / 0.14"; 3.0 m / 10 ft.. 117
Power Link Installation Cable in cable reels - for self mounting, Ø 5.0 mm / 0.2", S/FTP/UTP, 6 wires + braided shield..... 104	RCA female to 7 pin DIN - adaptor..... 117
Power Link Product Cable with plugs, Ø 3.5 mm / 0.14", STP/UTP, 6 wires + braided shield; (GND/shields on pin 3 and pin 7 are short-circuited when an RJ 45 is part of the cable)..... 105	Mini Jack Stereo to 7 pin DIN - adaptor..... 118
Power Link Product Cable with plugs, Ø 2.5 mm / 0.1", FTP, 4 wires + braided shield..... 106	RCA female to 5 pin DIN - adaptor..... 118
Power Link Product Cable in cable reels - for self mounting, Ø 2.5 mm / 0.1", S/FTP/UTP, 4 wires + braided shield..... 107	S/P-DIF / RCA / Line cables 119
Obsolete Power Link Product Cable with plugs, Ø 3.5 mm / 0.14", STP/UTP, 6 wires + braided shield; pin 3 and pin 7 are short circuit..... 108	IR solutions 120
Obsolete Power Link Product Cable with plugs, Ø 5.5 mm / 0.24", S/FTP/UTP, 6 wires + braided shield 109	IR-receiver with control buttons 120
Obsolete Power Link Product Cable with plugs, Ø 2.5 mm / 0.1", FTP/UTP, 3 wires + braided shield..... 110	Low-capacity IR-receiver cable..... 121
Power Link Splitters 111	IR-eye with Autocontrast 122
Power Link Splitter Cable 111	IR-eye without Autocontrast 123
Power Link Splitter Cable - subwoofers 112	IR-blaster cables..... 125
Power Link Splitter - Mini Jack to 2 DIN - Ø 3.5 mm; 2.5 m / 8 ft 113	Adaptor cables - IR-blaster..... 125
Power Link Splitter Box 3 x RJ45 female 113	Atlona optocoupler IR cables 126
Power Link Adaptors..... 114	Atlona IR cables..... 126
Power Link Adaptor DIN (female) to DIN (female)..... 114	Connectors - jacks - plugs - sockets 127
Power Link Adaptor RJ45 to DIN (female) 114	DIN plug, male..... 127
	DIN socket, female..... 127
	Coax plug..... 127
	Master Link plug..... 127
	F-connector insert 128
	SCART 21-pin-out..... 128
	SCART to SCART product cable..... 128
	SCART to A/V adaptor 129
	RJ45 jacks/socket - for wall outlet and brackets 130
	RJ45 plug w. screen for Cat cable 130
	RJ45 plug for Ø 2.5 mm PL cable 130

Conduits and cable trays.....	131	Assembly of connectors - sockets (jackets) and plugs	144
<i>Cable tray, narrow</i>	131	<i>Assembly of RJ45 connector (socket/jacket) - for wall outlet - Network Link</i>	
<i>Cable tray, semi-circular</i>	131	<i>Installation Cable</i>	144
Installation accessories	132	<i>Assembly of RJ45 plug for Cat 7 Network Link Product Cable</i>	147
<i>Wall socket, Master Link socket</i>	132	<i>Assembly of Master Link plug for Master Link Cable</i>	150
<i>Wall socket, DIN 8-pin</i>	132	<i>Assembly of RJ45 plug for Ø 2.5 mm Power Link cable - no-tool-mounting;</i>	
<i>In-wall base - DK FUGA</i>	132	<i>see page 130</i>	153
<i>On-wall base</i>	133	<i>Assembly of Power Link cables - Junction Box - 8, 6 or 5 wire; see page</i>	
<i>Flush-fit socket - round</i>	133	<i>135</i>	155
<i>Cover plate</i>	133	Troubleshooting	157
<i>Outdoor socket - base</i>	134	Troubleshooting LAN networks and Network Link networks.....	157
<i>Flush-fit kit for ML transceiver - round - in-wall</i>	134	<i>Initial checks regarding connection</i>	157
Junction boxes.....	135	<i>BonJour Browser</i>	157
<i>Power Link Junction Box</i>	135	<i>Drop out</i>	158
<i>Master Link socket - wall outlet</i>	135	<i>Fing - network scanner</i>	158
<i>Master Link Junction Box - small</i>	136	Connectivity information	158
<i>Master Link Junction Box - large</i>	137 <i>External communication (WAN)</i>	
<i>Master Link Distributor</i>	138	158	
Cabinets	139	<i>Connectivity - BeoLink Network</i>	159
Patch Modules.....	140	<i>Connectivity - Fast Precision Streaming (FPS)</i>	160
Brackets for cabinets.....	140	BeoTool	161
Brackets for 19" racks	140	Troubleshooting HDMI networks.....	162
Wall Plates.....	141	Troubleshooting Master Link	163
<i>Network Link Wall Plate, FUGA</i>	141	<i>Short circuit ML-sense</i>	163
<i>Network Link Wall Plate, Opus</i>	141	<i>Fault (a) No sound and no operation</i>	164
<i>Network Link Wall Plate - US</i>	141	<i>Fault (b) No sound but operation OK</i>	165
<i>Network Link Wall Plate - UK</i>	142	<i>Fault (c) Playing is at half volume</i>	165
<i>Network Link Wall Mount</i>	142	<i>Fault (d) No reaction when selecting a source from another product</i>	165
<i>Network Link Wall Plate</i>	142	<i>Service mode</i>	165
Various	143	Troubleshooting Power Link	167
<i>Galvanic isolator</i>	143	<i>Noise in speakers</i>	167
<i>Nanoperm coil</i>	143		
<i>Balanced to non balanced converter box</i>	143		

Questions & Answers	168
Passive Infrastructure	168
Active Infrastructure.....	169
General Terms - definitions	170
Network Link	170
Master Link.....	170
Power Link.....	170
Installation cable - horizontal cable	170
Product Cable.....	170
Patch cable	170
Master Control Link	170
Cat	170
Cat 7/Class F installation concept.....	171
<i>Recommendation on choice of installation cable.....</i>	<i>171</i>
Cat cable - colour coding of wires.....	172
Option.....	173
Glossary & Abbreviations	174
Index	178
Table of Contents.....	183