

Sunny Boy 2500

Technical Description

Issue 1.1

String Inverters for Photovoltaic Plants

Explanation of Symbols used in this Document

To enable optimal usage of this manual and safe operation of the device during installation, operation and maintenance routines, please note the following description of symbols:



This indicates a feature that is important either for optimal and comfortable usage or optimal operation of the system.

Example: "To keep string voltage low we recommend the following procedure."



This indicates a fact or feature which is very important for the safety of the user and / or which can cause a serious defect if not applied appropriately.

Example: "Disconnect the mains plug before opening the case!"



This indicates an example.

Table of Contents

1	Introduction.....	6
2	System Description.....	7
2.1	String Technology	8
2.2	Diagnosis and Communication	10
2.3	Technical design of the Sunny Boy 2500.....	11
3	Installation	16
3.1	What must be done in case of transport damages?	16
3.2	Placement of the Sunny Boy.....	17
3.3	Electric Connection	22
3.3.1	Connection to the Electricity Grid	23
3.3.2	Connection of the PV-panels.....	25
4	Commissioning.....	27
5	Operation and Failure Indication LEDs.....	29
5.1	Opening and closing of the Sunny Boy	43
6	System Monitoring and Diagnosis	47
6.1	Data Transmission via Powerline.....	47
6.2	Data Transmission with a Separate Data Cable	49
6.3	Upgrading or modification of the Sunny Boy interface	57
6.4	Graphic User Interface under Windows	60
6.5	Measuring Channels and Messages of the Sunny Boy	62
6.6	Measurement Precision	65
7	Troubleshooting.....	66
8	Warranty Regulations and Liability	68
9	Technical Data	70
10	Appendix	78

Important Safety Notice:



The Sunny Boy String Inverter may only be opened by qualified personnel for both maintenance and modification.

The device can still be charged with very high hazardous voltages even when disconnected.

For optimal safety closely follow all steps as described in the chapters 3, “Installation” and 5.1, “Opening and closing of the Sunny Boy”.

1 Introduction

By purchasing a Sunny Boy^{® 1} String Inverter you have decided to use one of the most advanced devices for modular PV system technology. The Sunny Boy inverters are the first systems that utilize the String Technology from SMA and convince with their outstanding qualities concerning efficiency and reliability.

The Sunny Boys comply with all regulations from the VDEW (Association of German Electricity Producers) for supplementary grid feeding to the low voltage electricity grid of the utility. This includes the regulations of the employee association (Berufsgenossenschaft für Feinmechanik und Elektrotechnik) concerning the “Independent Disconnection Device“ known as MSD (Mains monitoring device with allocated Switching Devices) and the regulations of the DIN VDE 0126. Furthermore the Sunny Boy complies with the according harmonised standards and the low voltage regulations as certified in the CE declaration (see appendix).

In the following you will find the technical description of the Sunny Boy 2500. Don't worry about its size, it is not necessary to read everything. This technical description is both installer's guide and user manual, so it is used as reference for the commissioning and as guideline on how to use all functions of the inverter optimally and how you can extend your existing PV-plant.

¹ *Sunny Boy* is a registered Trademark of SMA Regelsysteme GmbH

2 System Description

The need to reduce the CO₂ emission and other pollutants resulting from energy conversions is becoming more and more apparent. Renewable energy sources can make an important contribution to solve this problem. The direct conversion of solar radiation to electric energy (photovoltaics) will play a substantial role in this essential matter world-wide.

Supplementary grid feeding includes the conversion of the DC voltage from the PV-panel to grid compatible AC voltage with so-called “inverters“ and the subsequent connection to the electricity grid in the house distribution.

Here the electricity from the PV-modules provides all consumers with electric power (household devices, lights etc.). In case that not enough energy is produced the additionally necessary energy is obtained from the grid. In case that there is a surplus of energy, this surplus is fed into the local grid and is therefore available for other consumers. This way every single kilowatt-hour is utilized and the electricity company’s power plants are relieved. In the most simple case a PV-plant therefore consists of two basic components: the PV-panel and the inverter.

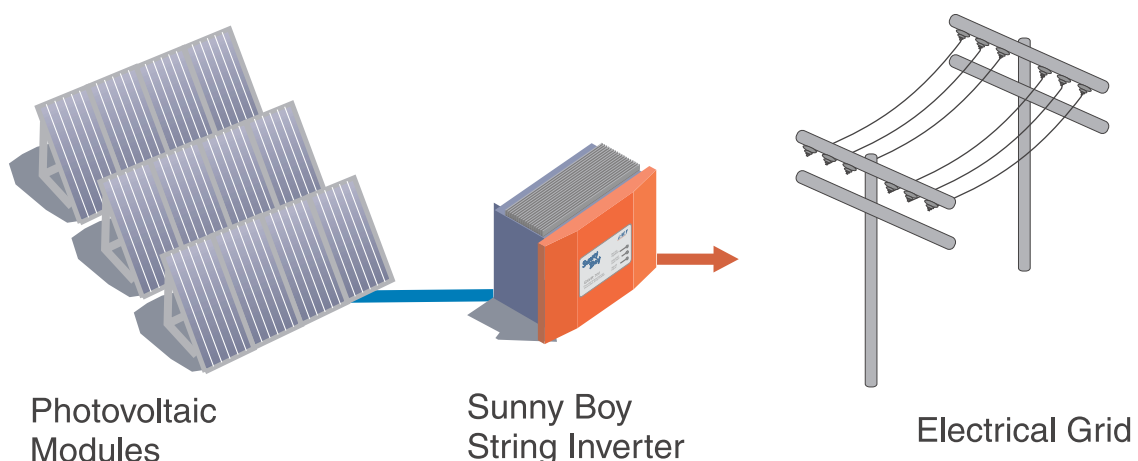

Fig. 2.1: Grid-tied PV plant

2.1 String Technology

The experience with several thousand grid-connected PV-systems in Europe with an output range from one to several hundred kilowatts has shown that the costs for grid connecting and monitoring the PV-system add up to almost 50 % of the costs for the entire system. To reduce these costs, especially the costs for the cabling on the DC side and the subsequent distribution on the AC side, and drastically simplify the design of PV-systems the string-technology was developed by SMA. The Sunny Boy finally enabled this new, considerably simpler and better affordable String Technology to be the standard system design for PV-plants.

String Technology means that a small number of PV-modules are connected in series to a "string", each string is then connected to a separate inverter which feeds the electricity of one string to the grid. Large PV-plants consist of a large number of single strings. The energy produced is collected directly on the AC side, making the system design very simple. No extra DC cabling is necessary anymore.

The most various system concepts can be constructed with modules of the **Sunny Boy family**.

- **Sunny Boy 700:**
The small inverter for little PV-plants and simple extension possibilities (3 input voltage and power ranges).
- **Sunny Boy 850:**
The output optimized inverter for PV-plants with at least 1 kWp.
- **Sunny Boy 1100E:**
For PV-plants with up to 1.5 kWp and equipped with a wider input voltage range.
- **Sunny Boy 1700E:**
For PV-plants around 2.2 kWp with a wide input voltage range.

- **Sunny Boy 2000:**
The transformerless string inverter with extended input voltage range and increased efficiency.
- **Sunny Boy 2500:**
The string inverter with electric separation and a broad input voltage range (250 ~ 600 V).
- **Sunny Boy 3000:**
The powerful string inverter with electric separation and optimum efficiency, ideal for large-scale plants.
- **Sunny Display:**
The optional integrated LCD display for direct data acquisition.
- **Sunny Data:**
The PC-program for communication with your Sunny Boy inverters.
- **Sunny Boy Control Family:**
The intelligent control terminals for your PV-plant for data acquisition, visualisation and saving.
- **Sunny Data Control:**
The PC-program for visualization of data from your Sunny Boy Control.

SMA is the European market leader for inverters for photovoltaic applications with over 100 MW of installed inverter power in over 60,000 single units with powers from 700 W up to 500 kW (11/01). The Sunny Boy is the result of a dedicated development resulting from the substantial experience with utility interactive inverters for photovoltaics.

2.2 Diagnosis and Communication

The modular PV system technology leads to a spread out distribution of the Sunny Boy String inverters. A simple and fast function monitoring of the status and measured values for each single Sunny Boy can be achieved with only a few system components. The data collected is either displayed on the LCD of the Sunny Boy Control or is shown on the screen of a PC running the according SMA software. Two programs "Sunny Data" and "Sunny Data Control" are based on a comfortable Windows GUI and allow the user to process the data with other programs such as MS Excel.

The signal transmission between the PC and the single inverters is normally done via Powerline communication (see chapter 6.1). The Sunny Boy String Inverters support the following monitoring concepts developed by SMA:

- PC with Sunny Data for Windows for small and medium size PV-plants, also with Sunny Boy Control.
- Sunny Boy Control as stand-alone controller for any PV-plant size.
- PC with Sunny Data Control for Windows together with a Sunny Boy Control.

Communication based on one of the above concepts supports the following functions:

- Continuous acquisition of operation data of all connected Sunny Boys.
- Supervision of operating states and failure indication.
- Spot value transmission from one or several selected Sunny Boys.
- Identification of failures in the single strings.
- Graphical representation of the data from single Sunny Boys or comparison of the data of several ones.
- Modification of operation parameters to optimise the entire plant.

2.3 Technical design of the Sunny Boy 2500

The Sunny Boy inverter is based on a power unit that operates with a very high efficiency and optimal reliability. A IGBT bridge converts the direct voltage coming from the PV modules to a high frequency AC secondary circuit with 16 kHz. The voltage is then fed to the grid after being processed by a low-loss toroidal-core current transformer.

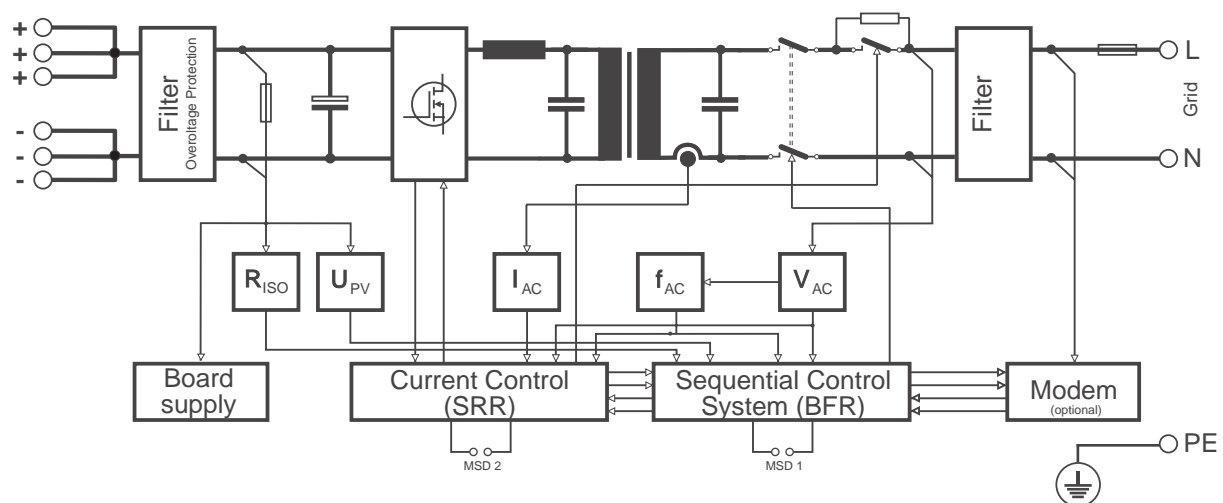

Fig. 2.2: Block circuit diagram of the Sunny Boy 2500

The PV input voltage range of the Sunny Boy 2500 is designed for up to 24 standard PV modules.

The current fed to the grid is perfectly sinus shaped and has a very low harmonic distortion due to the fact that a one-chip computer manages the control. The sequential control system takes care of fully automatic operation and handles the MPP-tracking (MPP = **M**aximum **P**ower **P**oint; fully automatic search for the PV output voltage with highest output power). The sequential control system minimizes unnecessary losses in standby and in grid feeding mode.

The heat sink is necessary in order to let the energy resulting from the power semiconductor devices dissipate. The Sunny Boy 2500 is equipped with a temperature monitoring system that detects too high a heat sink temperature (e. g. resulting from

high ambient temperature), reduces the power fed to grid and nevertheless keeps feeding electricity to the grid.

The sequential control system also manages the communication with the corresponding SMA data analysis tools Sunny Display, Sunny Data and Sunny Data Control. The Sunny Boy therefore is not only a simple standalone device as it can be part of one big PV-plant that has one central control and monitoring facility.

Two independent one-chip computers monitor the grid. This fully complies with the according regulations of the VDEW and the employee associations. The grid monitoring is done by determining the grid impedance with a so-called MSD (Mains monitoring with allocated Switching Devices, German = ENS). This means the Sunny Boy can be connected to the in-house network at practically every spot which substantially simplifies its installation. The relevant regulations and standards of course must be kept to.

The case is made of stainless steel which protects the inverter from dust and water up to IP 65. The Sunny Boy can therefore be mounted nearly anywhere inside or outside the house with an ambient temperature range of -25 °C to $+60\text{ °C}$.

Personnel protection is a very important issue even with small PV-plants. The grid and the PV-panels are electrically separated while the insulation is constantly monitored. All applicable standards and regulations for personnel safety and EMC are complied with.

Disconnection from Grid (MSD)

This section covers the safe disconnection and shutdown of the inverters in case the public electricity grid goes down. If the electricity supplier disconnects part of his electricity grid e. g. to make repairs one has to make sure that nobody working on the grid is harmed. In August 1994 a new safety concept was included into the VDEW regulation initiated by the “Berufsgenossenschaft für Feinmechanik und Elektrotechnik“ (German Employee Association of Precision Mechanics and Electronics Engineering).

The Sunny Boy string inverter is designed only for utility interactive operation. To ensure safe shut-down in case of grid disconnection etc. and to avoid an “islanding condition” the inverter is equipped with an independent disconnection device that has been certified by the “Berufsgenossenschaft für Feinmechanik und Elektrotechnik“.

The regulation is called **“Automatic disconnecting facility for photovoltaic installations with a nominal output ≤ 4.6 kVA and a single phase parallel feed by means of an inverter into the public low-voltage mains“**.

For maximum safety this independent disconnection device consists of two separate MSD (Mains monitoring with allocated Switching Devices) that are connected in series. Each of these MSD constantly monitors the grid quality by checking the frequency, voltage and impedance. The redundant circuit and an automatic self test on each system startup ensure a reliable function of the disconnection.

Older islanding detection systems only evaluated the voltage of the 3 phase electricity grid. The new detection system additionally evaluates the grid impedance of the feeding phase as well as the voltage and the frequency of the connected phase.

Conditions that cause the Sunny Boy to be disconnected from the grid:**• Grid Impedance**

- The Sunny Boy does not start to feed to the grid if the grid impedance Z_{AC} is higher than 1.25Ω .
- The Sunny Boy is disconnected from the grid within 5 seconds once the grid impedance increases drastically within a short time ($\Delta Z_{AC} \geq 0.5 \Omega$) or the impedance gets too high ($Z_{AC} \geq 1.75 \Omega$).

• Grid Voltage

- The grid voltage may be within a range of -15 % and +10 % of the nominal grid voltage U_N . Once the grid voltage exceeds this range the Sunny Boy is disconnected from the grid within 0.2 s.

• Grid Frequency

- The grid frequency may be within a range of ± 0.2 Hz of the nominal grid frequency f_N while the voltage is within a range of -30 % and +15% of the nominal grid voltage U_n - once the frequency goes beyond this range the Sunny Boy is disconnected from the grid within 0.2 s.
- Furthermore the Sunny Boy disconnects from the grid within 0.2 seconds once the grid frequency changes drastically exceeding a certain range.

This new Sunny Boy disconnection concept provides maximum safety with minimum installation effort due to the fact that the connection of the MSD must only be done to one single phase.

The value of the grid impedance measured at the Sunny Boy is the total of the impedance of the public grid and the cabling impedance in the house (from house distribution to the Sunny Boy). Excessive increase of grid impedance through the connection cable to the inverter therefore has to be avoided.



Keep in mind that the cable between the Sunny Boy and the house distribution increases the impedance (see chapter 3.3.1, "Connection to the Electricity Grid").

The MSD regulations require a type verification and test by an independent certified testing association. It is also required that the supplier of the inverter tests every single MSD before delivering the inverter to the customer. For the user this means:

- The intensive testing of the disconnection device by the electricity company and the installer and
- periodic checking of the disconnection device, legally required previously, are not necessary anymore.

The redundant design of the MSD and the regular self test on startup allow the user to get along without periodic tests. Each startup includes a function test in order to make sure that the allocated switching devices (transistor bridge and relay) are operating. The self test is repeated in case the test result was negative - if the failure persists the device must be checked by a qualified technician. The failure is indicated by a warning LED meaning that the inverter is not feeding electricity to the grid. The system shutdown because of MSD malfunction cannot be reset with external signals in order to ensure that the device is checked and set up for grid feeding only by qualified personnel.

3 Installation



The installation of the Sunny Boy string inverter must be done by qualified personnel that is approved by the local electricity company.

Make sure that all instructions in this chapter are followed.

Follow all safety regulations and regulations of the local electricity company.

3.1 What must be done in case of transport damages?

The inverters are thoroughly checked before they are shipped. Even though they are delivered in a sturdy packaging (which can be recycled) the inverters can be damaged in transit, which is usually the forwarder's fault.

Please inspect your inverter thoroughly after it is delivered. If any damages can be detected on the packaging that could make you conclude the contents is damaged or if you detect that the inverter is damaged please immediately notify the forwarding company.

SMA or your local supplier can help you in this matter. In any case a declaration of transport damage must be made within 6 days upon receipt of the product and must be stated in writing directly to the forwarding agent. If it is necessary to return the inverter to the manufacturer please use the packaging the inverter was sent in.

3.2 Placement of the Sunny Boy

The Sunny Boy is a complicated electronic device and is therefore sensitive to humidity within the case.



If the Sunny Boy is placed outside, the humidity during the installation should be as low as possible - pay special attention that it does not rain. If moisture is enclosed in the case it will eventually condense within the device which could damage the electronics.

A suitable position must be found for the inverter/s while the PV-plant is designed. To find the optimum location please consider the following most important criteria.

Criteria for device mounting:

- Due to the high protection class IP65 the installation is possible indoors and outdoors.
- If possible, do not expose the inverter to direct moisture despite IP65.
- Keep the DC cabling from the solar generator to the inverter as short as possible.
- Avoid installation in the living area because a slight noise emission is possible.
- Avoid mounting on resonant parts (e. g. thin wooden panels, plaster panels, etc.)
- Provide accessibility for installation and later service.
- Installation at level height makes it possible to easily view the operating LEDs.

Please note the following points in any case:



- The mounting background must be firm.
- The ambient temperature must lie between -25 °C and $+60\text{ °C}$.
- Keep an eye on the grid impedance at the connection point (see “Disconnection from grid (MSD)” and chapter 3.3.1, “Connection to the Electricity Grid”).
- Do not expose the string inverter to direct sunlight - this could reduce the energy yield (if necessary install a sun shield).
- A minimum distance of 200 mm must be clear above the inverter for ventilation, i.e. no cupboards, ceiling, etc.
- The free air circulation around the case must not be obstructed to ensure sufficient cooling.
- If you install the Sunny Boy in a cabinet or closet etc., the air circulation must be sufficient for heat dissipation - provide external ventilation.
- The heat sink can reach a temperature of more than 80 °C .
- Provide a correct position of the inverter see below:

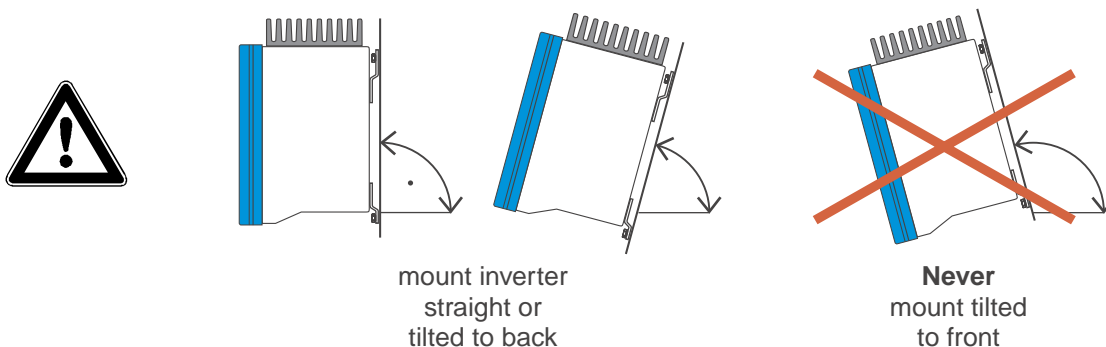

Fig. 3.1: How to mount the inverter

Packing list for mounting and installation

The following components provide for safe and simple installation of the Sunny Boy and are included in the packing list:

	Sunny Boy 2500
Drilling template in appendix	1 pc.
AC-connection socket set	1 pc.
Seal for AC connection socket	1 pc.
Seal for MC plug	2 pc.
Seal for MC socket	2 pc.
Cable gland PG16	1 pc.

Tabelle 3.1: Packing list for mounting and installation

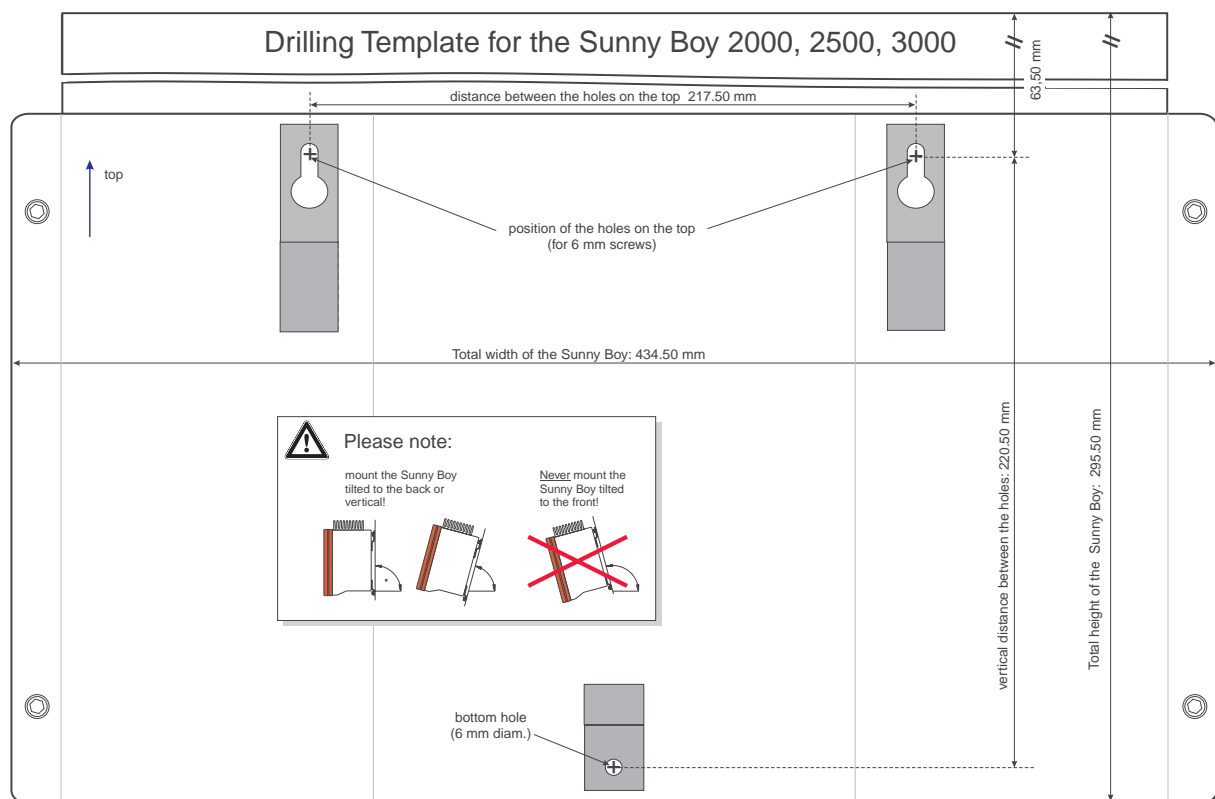

Fig. 3.2: Picture of drilling template - original template in appendix

Preparing the Mounting

The Sunny Boy is mounted on its back with 3 metal straps on a firm surface. 3 screws and the corresponding dowels are necessary. The screws and dowels are not included and have to have a sufficient size. We recommend 6 mm screws and 8 mm dowels.



For outside mounting use stainless steel screws. If necessary plastic washers should be inserted between the screw and metal strap in order to avoid scratching the paint when screwing.

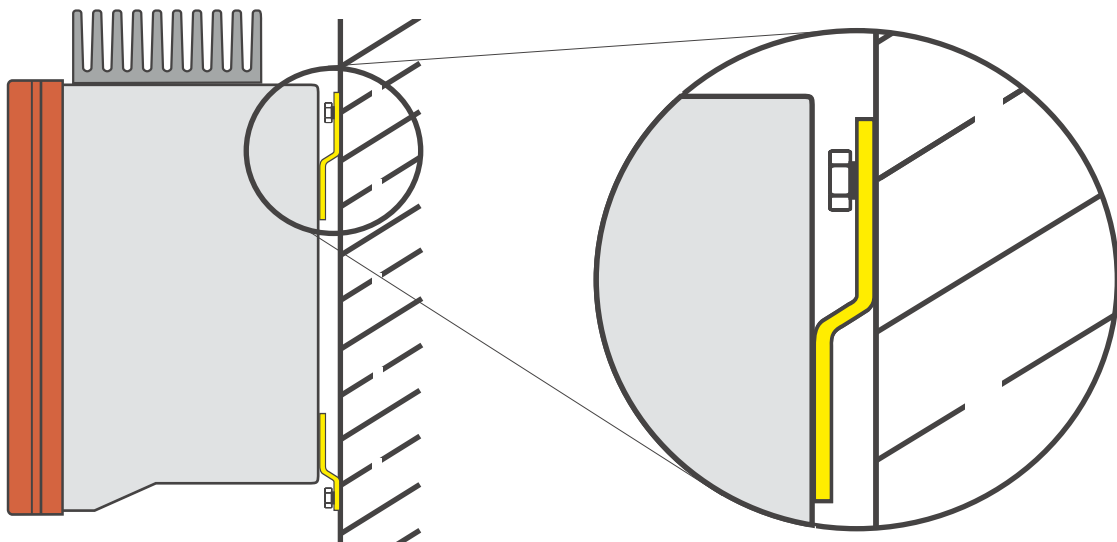

Fig. 3.3: Side view of mounting to wall

Metal straps for mounting:

The top straps take the load, the bottom is screwed down in order to prevent tilting off the wall.

Securing the Sunny Boy against lifting up:

After the Sunny Boy has been hanged into the top screws fasten the bottom screw to secure against lifting up.

Mounting to wall

- Mark the holes with the drilling template.
- Drill the holes (and put in the dowels), put in the screws of both top holes and screw them in until ca. 4 mm are sticking out.
- Hang the inverter into the two top screws.
- Fasten the bottom screw in order to prevent lifting up.
- Check the mounting of the inverter.

3.3 Electric Connection

The electric connection of the Sunny Boy can be done once the device is correctly mounted in its position.

The grid and the input from the PV-modules are connected to the inverter in the bottom of the case. The connection is done with special plug connectors (see Fig. 5.3).



The connection of the Sunny Boy to the DC voltage from the PV string and the AC voltage of the utility must be done in the order described here. This ensures that the disconnecting of contacts as well as hazardous voltages during the installation are avoided.

1. Connect to the electricity grid (see chapter 3.3.1)
2. Connect the PV string (see chapter 3.3.2)
3. Connect the PV string to the Sunny Boy
4. Connect the utility by putting the fuse on

Disconnecting the Sunny Boy must be done in the opposite order:

1. Disconnect the inverter from the grid (automatic circuit breaker "OFF")
2. Disconnect the PV panel from the Sunny Boy (pull the MC plugs)
3. Remove the AC connector from the Sunny Boy

3.3.1 Connection to the Electricity Grid

The Sunny Boy must be connected to the grid with three cables - one phase, one neutral and one protective earth (PE).



We recommend a 16 A automatic circuit breaker. No consumers are allowed on this circuit or they have to be fused separately.

The grid impedance value at the connection point must be lower than 1.0Ω in any case in order to fulfill the necessary conditions for the MSD (see chapter “Mains monitoring with allocated switching devices”).



The impedance is the sum of the electricity grid impedance at house distribution and all impedance values of cables and clamping points.

NB: Impedance values are

- ca. 0.48Ω for a 20 m cable with a cross section of 1.5 mm^2
- ca. 0.50Ω for a 35 m cable with a cross section of 2.5 mm^2

The AC connector socket for utility connection can take a cross section of up to 2.5 mm^2 .



Make sure the grid is disconnected in the fusebox before you connect the AC connection socket.

The AC connector is a round socket that is suitable to take different cable diameters. A PG13.5 and a PG16 cable seal are included with the AC connection socket. Check which size is suitable for your AC connection cable.

Strip the insulation off the ends of the cable and connect the cable to the AC socket as shown in Fig. 3.4 “AC connection socket”.

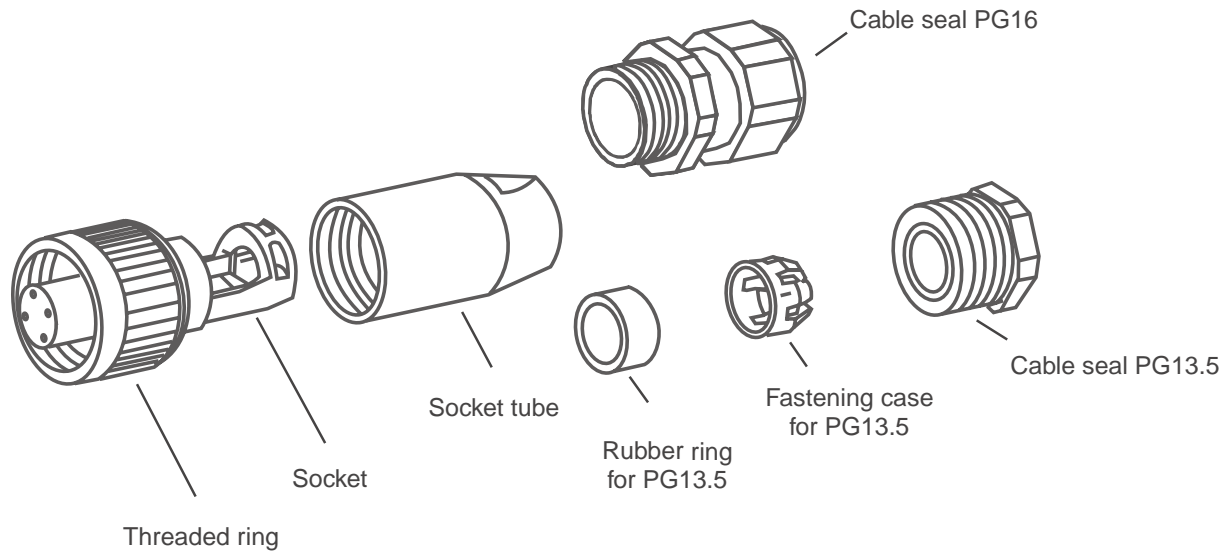

Fig. 3.4: AC connection socket

- Push the rubber ring into the fastening case.
- Put the cable through the PG 13.5 or 16 cable seal. Put the cable through the fastening case with the rubber ring and through the socket tube.
- Connect the wires of the AC cable as follows:
 - Protective Earth (PE) to the terminal with the “ground” symbol
 - Neutral wire to the terminal marked with “1”
 - Phase L to the terminal marked with “2”
 - The terminal marked with “3” is not used.
- Make sure that all wires are firmly connected.
- Push the socket tube firmly onto the socket.
- Screw the cable seal firmly onto the socket tube.
- For cables that require the PG16 gland: Tighten the bolt of the PG16 gland.
- The AC connector socket is now ready to use.
- Seal the AC connector socket in case you do not insert it into the Sunny Boy.

- The AC connector socket can be inserted into the Sunny Boy in case the Sunny Boy is already mounted in the correct position. Remove the transparent seal from the AC connector on the Sunny Boy, insert the AC connector plug and tighten the seal.

3.3.2 Connection of the PV-panels

Safety Notice

The inverter system is electrically separated in order to provide maximum protection against dangerous touch voltage in the PV-plant. This means that neither the + nor the – cable are electrically connected to the PE, i.e. there is normally no dangerous voltage between the PE and the + or - pole.

The Sunny Boy constantly monitors the electrical resistance of the + and - poles to PE. The red LED is switched on whenever resistance is below 1 M Ω (see chapter 5, “Operation and Failure Indication LEDs“).



The voltage between the + and - pole of the PV-modules (string voltage) can be lethal!

The circuit that monitors the insulation results in a slight electric connection to the PE. The very high resistance of the circuit normally prevents a dangerous current from flowing through the human body. However, high resistance voltage meters will indicate voltage between the case of the string inverter and the plus and/or minus poles.



Never disconnect the PV-modules from the Sunny Boy (by pulling the Multicontact snap cable connectors) before disconnecting the grid, i. e. never during feeding operation of the Sunny Boy! Always disconnect the Sunny Boy from the grid first - the Sunny Boy will then stop feeding to the grid and the Multicontact connectors are not under load anymore.

Connection to the PV-modules

In order to simplify safe mounting and servicing the Sunny Boy is connected to the PV-modules with safe to touch snap cable connectors type Multi-Contact which were especially designed for PV applications.



Make sure that the + and – snap cable connectors of the PV-modules are connected to the right poles of the PV module voltage.

Depending on the type of PV-module used it is possible to connect one single string or two or three parallel strings. Therefore there are three connections for both the + and the – pole. Within the device these connections are connected in parallel each.



Should you be working with one single string connection please close the snap cable connectors on the Sunny Boy that are not used by the seals provided with the delivery.



Before connecting the snap cable connectors of the PV-panel to the Sunny Boy check the correct polarity and admissible PV-panel voltage between the + and the – snap cable connector of the PV-panel.

The PV-panel voltage must be below or at most equal 600 V DC ($U_{PV} \leq 600 \text{ V DC}$).

The PV-panel is connected to the Sunny Boy with the MultiContact connectors on the left-hand side at the bottom of the case.

4 Commissioning

Safety notice



Check that no tools, wires or similar equipment are placed on the case of the Sunny Boy 2500 during operation.



On top of the device you can find the heat sink of the Sunny Boy with potential temperatures of over 80 °C. **Danger of burning.**

First switching on

If the correct polarity and an admissible level of PV-panel voltage have been confirmed in the measurement (see chapter 3.3.2) remove the seals from the snap cable connectors at each end of the PV-panel cable.

- Mount these to the Sunny Boy until they have full contact. As soon as the PV-panel has been connected via the Multi-Contact[®] plug connectors, internal PV-panel voltage is on.
- Connect the grid voltage by closing the circuit breaker of the supply lead.

If the input voltage is high enough the Sunny Boy should start to feed inverted PV power fully automatically to the grid, once enough power is coming from the PV-modules.

The design of the Sunny Boy makes sure that its internal consumption is as low as possible. The Sunny Boy requires a maximum 7 W internal consumption which it takes from the PV-panel.

If you measure the voltage coming from the PV-modules you must keep in mind the inverter's internal consumption that will have an effect on your measurement with lower solar radiation. The open circuit voltage of the PV-panel will therefore not be

displayed. The internal consumption is negligible for the voltage measurement with higher solar radiation.

The operating state of the Sunny Boy will be indicated with three LEDs integrated into the lid. The meaning of the LEDs will be explained in chapter 5, "Operation and Failure Indication LEDs".

5 Operation and Failure Indication LEDs

General

The inverter normally operates automatically, without user interaction and without any maintenance. The inverter automatically turns itself off when a grid feeding is not possible (e. g. at night).

The Sunny Boy automatically starts its grid feeding the next day once the solar radiation is high enough. The inverter goes to standby mode if the radiation and the resulting electric input energy is too low and is therefore always ready for operation.

Each time the Sunny Boy starts up it runs a number of self tests and safety procedures.

The green LED "Operation" indicates the current operation.

The red LED warns the user that an "Earth Fault" has occurred. A description of this situation and what has to be done in that case is given in the section "Earth Fault Indicator".

The yellow LED "Failure" indicates an internal or external failure that keeps the inverter from feeding the grid. The specific causes for this and how to avoid them are described in detail in section "Failure Indication".



Fig. 5.1: Front view of part of the Sunny Boy

Description of the symbols used in the following section:

- ⊗ LED off
- ◐ LED blinks once per second
- ⊗ LED blinks fast (ca. three times per second)
- ◑ LED on with short interruptions (75 % on, 25 % off)
- LED is constantly on
- not relevant



























LED indicator		Operating Condition	Description
green:		standby (night)	input voltage < 85 V
red:			
yellow:			
green:		initialization	input voltage 85 V – 225 V
red:			
yellow:			
green:		stop	changing operating condition or manually initiated condition
red:			
yellow:			
green:		waiting, checking grid	starting conditions are being checked
red:			
yellow:			
green:		feeding grid MPP or constant voltage mode	normal operation
red:			
yellow:			
green:		derating	Reduction of power fed to the grid due to increased heat sink temperature
red:			
yellow:			
green:		isolation failure	earth fault of the PV-panels or failure of surge voltage protection
red:			
yellow:			
green:		failure	internal or external failure, exact description depending on blink code
red:			
yellow:			
green:		permanent device disable	failure of MSD
red:			
yellow:			

Table 5.1: Sunny Boy operation indication overview

Operation Indicator

Standby (night)

Operation ——— ⊗ All LEDs are off.
Earth Fault ——— ⊗
Failure ——— ⊗

The Sunny Boy is in “standby (night)” mode. The input voltage is too low ($U_{PV} < \text{approx. } 85 \text{ V}$) to supply the Sunny Boy control system with enough power.



Initialization

Operation ——— ● All LEDs are on.
Earth Fault ——— ●
Failure ——— ●

The Sunny Boy control system is initializing.

The string voltage to the inverter is between approx. 85 V and 225 V. The supply is sufficient for the system control and not quite sufficient for feeding to the grid. Data transmission is not possible yet.

Stop

Operation	— 	Green LED blinking (approx. three times per second)
Earth Fault	— 	Red LED off
Failure	— 	Yellow LED off

The inverter has stopped operation, among other things the measurement electronics is calibrated. Subsequent condition is “Waiting”.

“Stop” condition can be initiated by the user with the Sunny Boy Control or the program Sunny Data. The Sunny Boy remains in this condition until set to “MPP-Operation” or “Constant Voltage Operation” or until reinitialized (e. g. after system shutdown).

Waiting, Grid Monitoring

Operation	— 	Green LED blinking once per second
Earth Fault	— 	Red LED off
Failure	— 	Yellow LED off

The Sunny Boy is checking the grid concerning its suitability for feeding electricity (starting voltage, starting time) and begins to monitor the grid.

Operation

Operation	—●	Green LED on
Earth Fault	—⊗	Red LED off
Failure	—⊗	Yellow LED off

The Sunny Boy has successfully completed self-testing electronics and the MSD and starts feeding to the grid.

- **“MPP“-mode (default setting):**

The Sunny Boy independently acquires the MPP voltage of the PV panel which is internally defined as PV setpoint voltage. In MPP mode the maximum power point P_{AC} is set by changing the required PV voltage at the PV-panel.

- **“Constant Voltage“-mode**

The voltage from the PV-modules can be set to a fixed value. This value (“U-Konst”) can be manually defined by the operator and transmitted to the Sunny Boy via the Sunny Boy Control or with the Sunny Data software. In the constant voltage mode the Sunny Boy uses a strictly defined PV voltage setpoint.

Earth Fault Indicator

Insulation failure, defective varistor

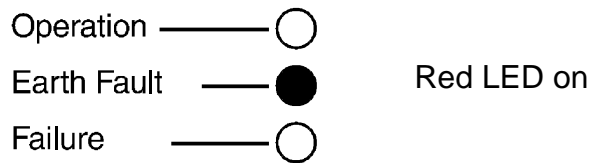

The Sunny Boy indicates an earth failure with the red LED. This condition can occur together with other indications.

The indication of “Earth Fault“ can result from two different reasons: Either the PV-panels connection has an isolation failure or one of the two or both thermally monitored varistors on the DC side have developed a high resistance and therefore do not let any current pass.

The possible failures are described in the following together with the methods to find out how to distinguish the reasons for the failure.

- **Insulation failure**

Failure at the PV-panel or PV connection. The plus or minus pole from the PV-panel or one of the PV-modules has a connection ($< 1 \text{ M}\Omega$) to the grounding earth, PE.



The repair of an insulation failure must be conducted by qualified personnel.

A low resistance connection between the plus or minus pole and the grounding, displayed as an isolation failure, results in the possibility of highly dangerous electric shocks while only touching one pole. That means that the user is in danger when touching one pole since the user himself normally is connected with the ground.

- **Failure of the thermally monitored varistors**

On its DC input side the Sunny Boy is equipped with thermally monitored varistors (plus and minus pole to protective earth each). They are installed in order to prevent the inverter from being destroyed by atmospheric surge voltages (electric fields from thunderstorms etc.). A thermally monitored varistor is the serial circuit of a varistor and a thermal fuse. If the thermally monitored varistors have triggered for several times they can lose their effect by not letting any current pass anymore and therefore not provide the intended safety anymore. This condition is indicated with the “Erdschluß / Earth Fault“ LED.



The replacement of a thermally monitored varistor should be conducted by qualified personnel.

- Determining the Failure

The red LED indicates one of the above mentioned failures. A short description on how qualified personnel can distinguish between these and conduct the appropriate countermeasures is given in the following.

Please take note of all relevant information in chapter 3.3, “Electric Connection” and 5.1, “Opening and closing of the Sunny Boy”.

- Open the Sunny Boy according to the description in chapter 5.1.
 - Remove the two internal thermally monitored varistors (see Fig. 5.3 “Interior of the Sunny Boy 2500”) with a screwdriver.
 - Connect the connectors 2 and 3 of the terminal strip on the main board.
 - Connect the PV-panel by the MC plug connector
 - Connect the grid voltage
- If the red LED is off see “A“ - if the LED is on see “B“.

- A The red LED is off. At least one of the thermally monitored varistors is defective. Replace both varistors - they are only available from the manufacturer because they are designed especially for the Sunny Boy.



The thermally monitored varistors are not available on the market but are especially designed for use in the Sunny Boy.

- B The red LED is still on. The following must be done:

- Disconnect the inverter from the grid.
- Disconnect all poles of the inverter from the PV-panels by pulling the Multi-Contact plug connectors.
- Wait 5 minutes until the internal voltage has discharged.
- Remove the bridges from 2 to 3 in the two connector blocks. Mount a bridge from connector 2 in one connector block to connector 2 in the other connector block.
- Re-connect the PV-panels and the grid to the Sunny Boy.



If the red LED is still on, the Sunny Boy is damaged and must be repaired by the manufacturer.

If the red LED is off the isolation of the Sunny Boy or the connection cabling is defective.

- Disconnect the Sunny Boy from the grid.
- Disconnect the PV-panel from the inverter by MC plug connectors.
- Now the isolation fault should be found and removed by taking appropriate measurements.
- Close the Sunny Boy as described in chapter 5.1.

Failure Indication

Consistent Failure

Operation — 
Earth Fault — 
Failure — 

The yellow failure LED is permanently on.

This is a failure of the grid monitoring or the autonomous disconnection device MSD. The Sunny Boy has detected a failure in the autonomous disconnection facilities and has suppressed the grid feeding. Further proceedings are described in chapter 7.

Blinking code 2: Grid Failure

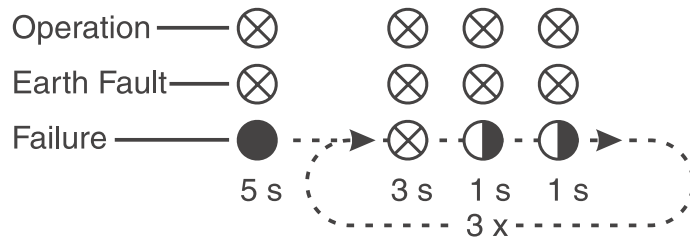

The yellow failure indication LED is activated for 5 seconds, is out for 3 seconds and then blinks twice. The code is sent three times.

If the failure consists the indication blinking code is repeated.

The Sunny Boy is indicating a failure which has one of the following reasons:

- Low grid voltage ($< V_{AC\ min}$ see Table 9.1)
- High grid voltage ($> V_{AC\ max}$ see Table 9.1)
- Low grid frequency ($< f_{AC\ min}$ see Table 9.1)
- High grid frequency ($> f_{AC\ max}$ see Table 9.1)
- Drastic change of frequency ($> |dF_{AC}|$ see Table 9.1)

Check the electric grid supply (check the function of other electric consumers) and check the fuse of the mains connector to the Sunny Boy.



If you do not find any failure have the grid connection to the Sunny Boy checked by a qualified electrician. Check the correct connection and the fuse in the Sunny Boy (see Fig. 5.3: Interior of the).



Do not forget to disconnect the Sunny Boy before opening the device. Follow the instructions for opening and closing of the Sunny Boy given in chapter 5.1.

Blinking Code 3: Grid impedance too high

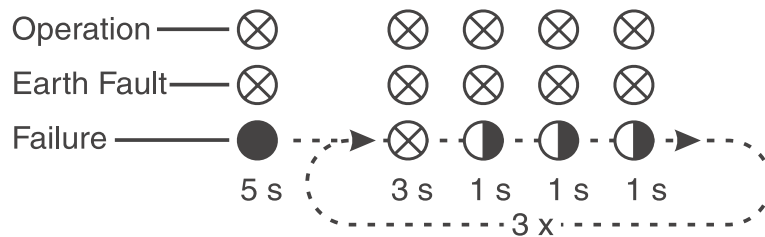

The yellow failure LED is activated for 5 seconds, remains dark for 3 seconds and then blinks three times. The code is sent three times.

If the failure consists the indication begins once again.

The Sunny Boy has detected a failure based on non-permissible grid impedance values. The criteria for the grid impedance are described in the section “MSD”.

A too high grid impedance can be the reason in case this failure occurs very often, forcing the inverter to switch off. The impedance can be checked with the Sunny Boy Control or Sunny Data. Should the impedance be $Z_{AC} \geq 1,25 \Omega$ the Sunny Boy may not connect to the grid. This failure can normally be avoided by increasing the cross section of the AC cable connected to the inverter.

Blinking code 4: Input voltage (PV-panel) too high

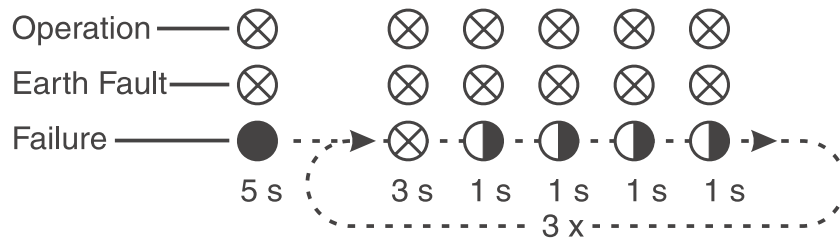

The yellow failure indication LED is activated for 5 seconds, is out for 3 seconds and then blinks four times. The code is sent three times.

If the failure consists the indication is repeated.

The input voltage is too high. The PV-panels are generating a voltage higher than the permissible specified voltage!



Disconnect the grid and then the PV-panels from the Sunny Boy immediately. Too high input voltages can cause a non-repairable damage.

Have the circuits of your PV-panels checked by your electrician. The permissible PV input voltage of the Sunny Boy is listed in the technical data in chapter 9.

5.1 Opening and closing of the Sunny Boy

Normally the Sunny Boy operates fully automatically and maintenance-free. Should the device nonetheless be opened e.g. for

- upgrading or modification of the Sunny Boy interface
- control of internal fuse
- analysis of earth fault indication

follow the instructions given below.

Opening of the Sunny Boy



The Sunny Boy must only be opened by a qualified electrician.

When working on the Sunny Boy follow the instructions below:

1. Separate the Sunny Boy from the grid by opening the circuit breaker.
2. Separate all poles of the Sunny Boy from the PV-panel by pulling the MC plug connectors.



Wait for approx. 5 minutes until internal voltage has discharged.

3. Open the Sunny Boy in the following order.
4. Take off the lid by removing screws 1-4 (see Fig. 5.2 on page 44) on the lid (M5).



Fig. 5.2: Front view of the Sunny Boy 2500



On the inside of the lid there is a tab connector contact with a green-yellow grounding cable (PE connection). Carefully separate this cable.

You now have the opened Sunny Boy in front of you and can see the position of components and clamps relevant for you. You will find:

- The internal fuse
- The thermally monitored varistors
- The control system board with the socket for the piggy back board for the communication

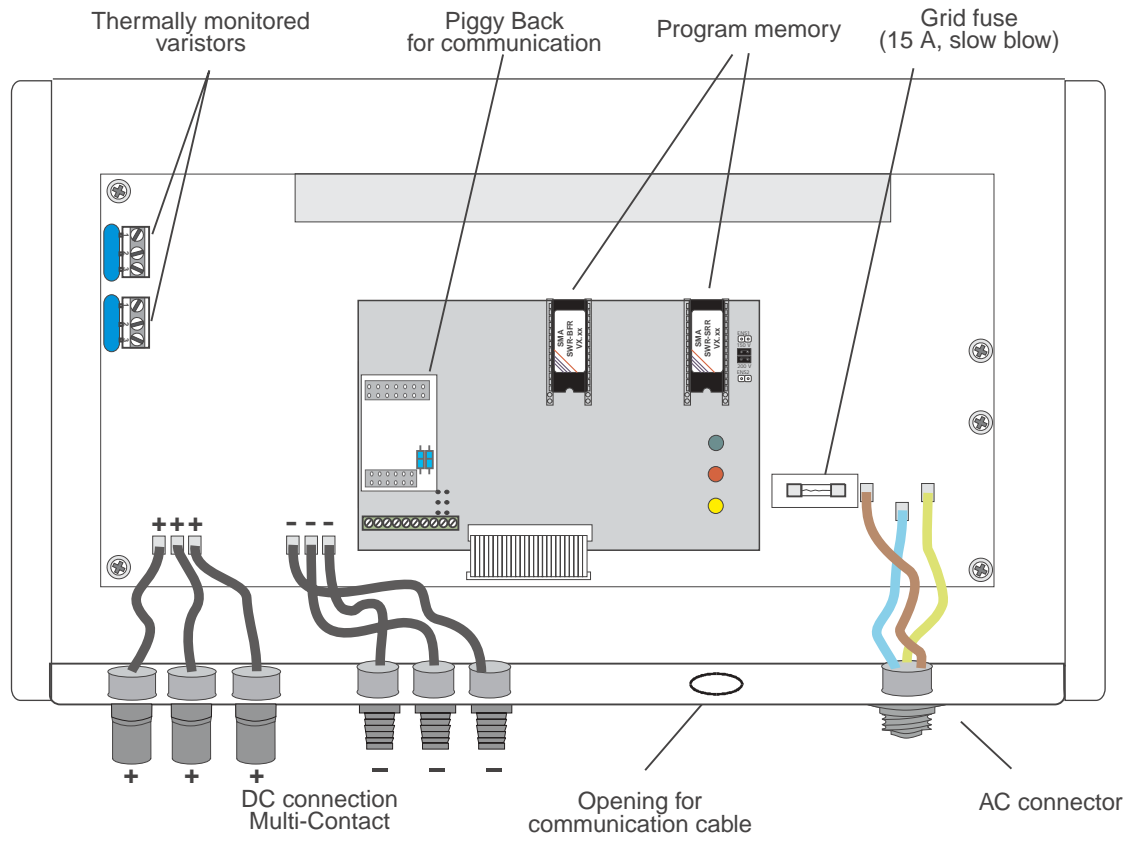

Fig. 5.3: Interior of the Sunny Boy 2500

Closing of the Sunny Boy

1. Restore the PE connection of the lid with the tab connector of the green-yellow PE conductor. When putting the lid on make sure the seal in the inner side of the lid is placed correctly. When screwing the inner screws make sure that the thread in the Sunny Boy case is not damaged by tilted screws. Under certain conditions the protection class IP65 cannot be guaranteed any more. When mounting the Sunny Boy outside moisture can get into the device and damage the electronics.
2. Connect the PV-panel by plugging on the MC plug connectors (see also chapter 3.3.2).
3. Connect the grid.

With sufficient power from the PV-panel the Sunny Boy should now start automatically feeding the grid.

6 System Monitoring and Diagnosis

6.1 Data Transmission via Powerline

Signal transmission between the Sunny Boy and the Sunny Boy Control or the PC is done with the grid connection via Powerline. This requires a minimum of installation (see below). The Sunny Boy must be equipped with a Powerline modem for data transmission. The PC must be equipped with the socket modem (SWR-COM). This is already integrated in the Sunny Boy Control, the specific controller for PV-plants. The PC or the Sunny Boy Control can be positioned anywhere within the in-house network as they acquire data directly from the AC circuit.

For trouble-free operation the Sunny Boys and the PC socket modem or the Sunny Boy Control must be connected to the same phase of the in-house network. If the communicating partners are connected to different phases the communication must be established with a so-called phase coupling device. The phase coupling device is available from SMA and must be installed by qualified personnel. It will make communication within the entire in-house network possible.

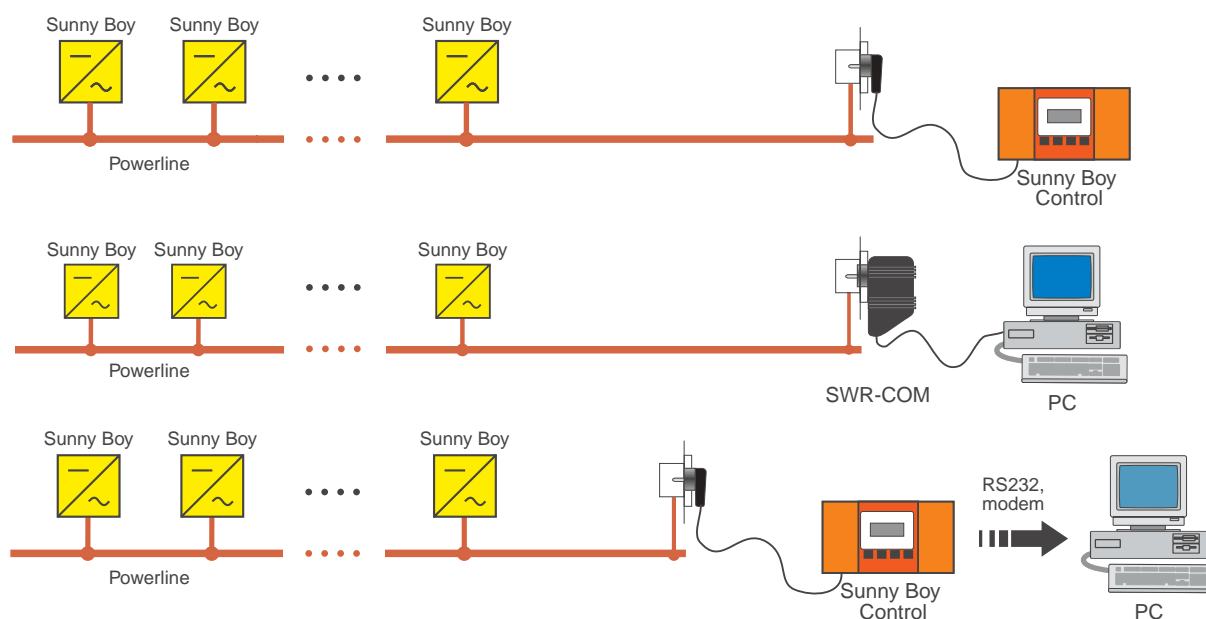

Fig. 6.1: Example of data transmission via Powerline

What do you need for Powerline communication?

- The Sunny Boy must be suitable for Powerline communication (order no.: SWRxxxx-NE:1x0). I. e.:
 - The Powerline piggy back modem is installed (see Fig. 6.3: System control board Sunny Boy with RS232 cabling).
 - The blue resistors under the piggy back have to be installed for Powerline communication (see Fig. 6.3).
- For communication with the PC
 - A socket modem SWR-COM is available.
 - Some PCs are equipped with a 25-pole COM interface. Then a small adapter is necessary (order no. 39-5010).
 - The visualisation software Sunny Data must be installed.

How to install Powerline Communication

- Powerline Communication with a PC

The RS232 connector from the SWR-COM is plugged into a free COM port of the PC. The SWR-COM is plugged into the electricity socket. For details on the visualisation software Sunny Data please see the Sunny Data manual.
- Powerline Communication with a Sunny Boy Control

Plug the 230V power cable of the Sunny Boy Control into the electricity socket. For operation of the Sunny Boy Control and the usage of Sunny Data Control for Sunny Boy Control refer to the according manuals.

6.2 Data Transmission with a Separate Data Cable



RS232 communication is only suitable for data transmission between a PC and **one single** Sunny Boy.

Data transmission via Powerline is a reliable and affordable solution. In electrical grids which are strongly influenced by high-frequency disturbance such as those in industrial sites data transmission via Powerline may not be possible. Communication between the Sunny Boys and the Sunny Boy Control or the PC can then be done with a separate data cable.

RS232 communication

If only one Sunny Boy has to be connected to the PC the easiest way is direct coupling via an RS232 port. A maximum of 15 m is permissible between the PC and the Sunny Boy.

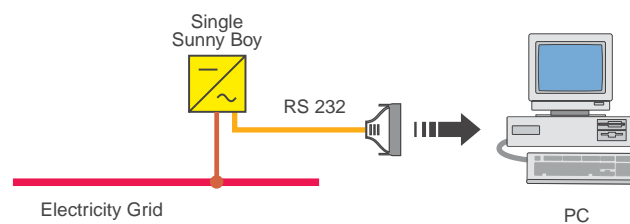

Fig. 6.2: Example for RS232 communication with a single Sunny Boy



RS232 communication with a Sunny Boy is only a reasonable solution with direct connection to the PC.

If a Sunny Boy Control is used instead of the PC an RS485 connection is necessary. See section “RS485 communication” for details.

What do you need for RS232 communication:

- A special RS232 Piggy-Back module and an appropriate cable gland for the Sunny Boy
- The visualization software Sunny Data is installed on the PC
- The light blue resistors (Fig. 6.3) on the system control board are removed.
- Some PCs are equipped with a 25 pin COM port. In this case a small adapter is necessary (order no. 39-5010).

Installation

- Please read chapter 6.3 carefully.
- Connect RS232 connection cable LIYCY; 0.25 mm², minimum three-cable with common shield and a maximum length of 15 m. You can see the connector layout in Fig. 6.3. The shielding should be connected to protective earth (PE) on both ends at the Sunny Boy and the PC case.

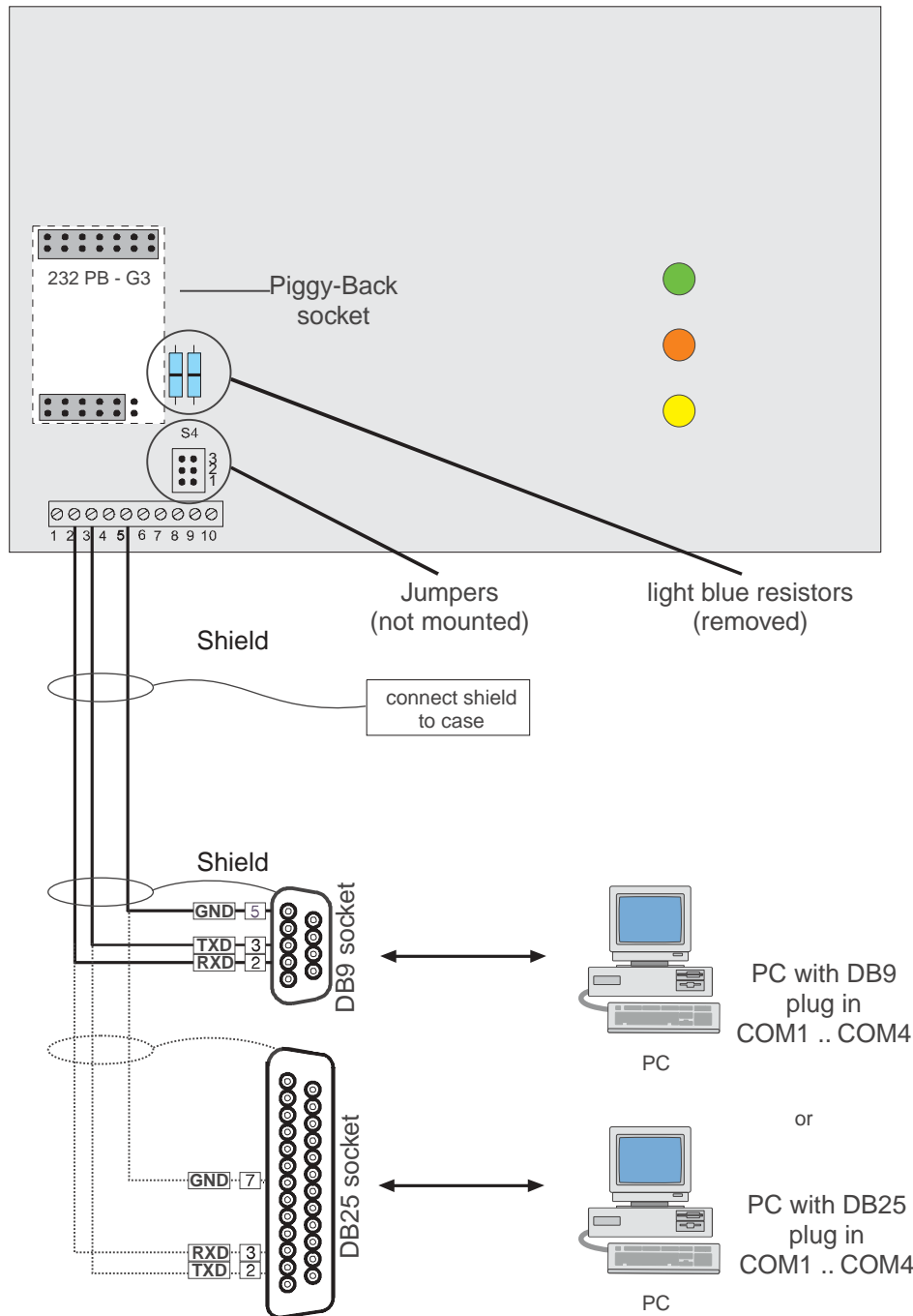

Fig. 6.3: System control board Sunny Boy with RS232 cabling

RS485 communication

In grids loaded with high interference several Sunny Boys can be connected to a PC or the Sunny Boy Control via RS485 and a separate data cable. Data cables of up to 1200 m are permissible.

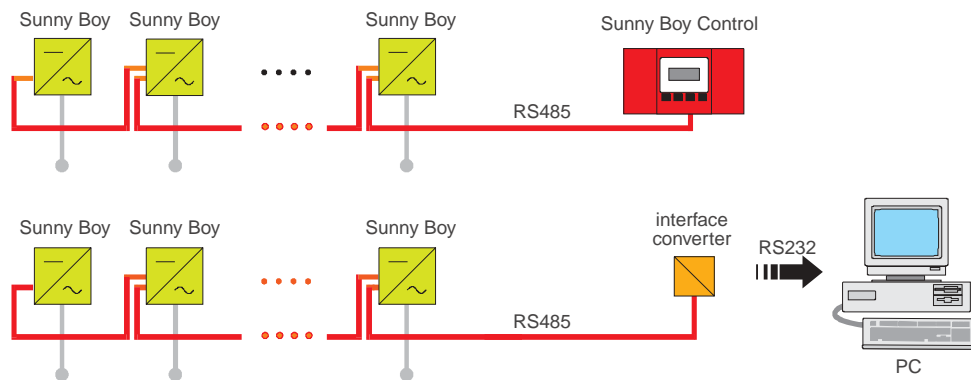

Fig. 6.4: Schematic layout of RS485 data transmission with several Sunny Boys

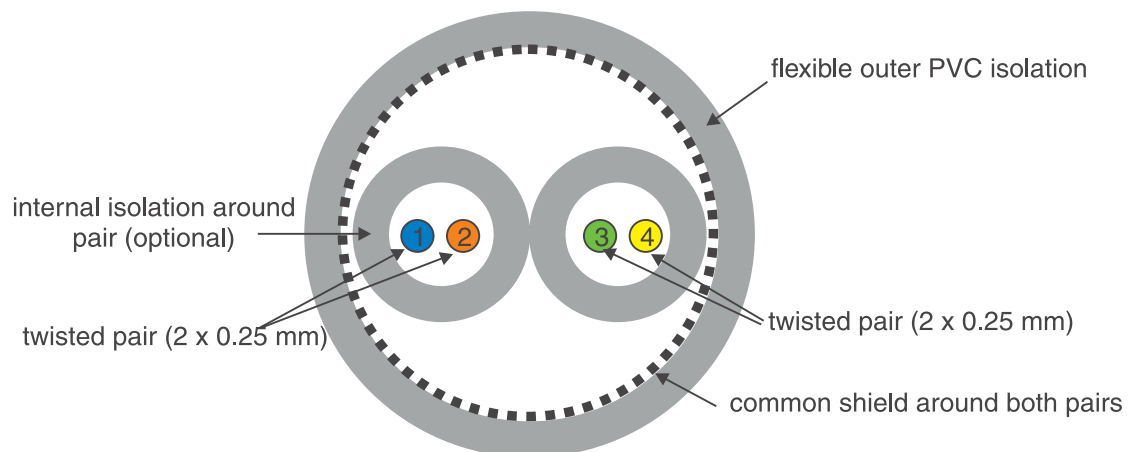

Fig. 6.5: Cross section of the recommended RS485 cable

What do you need for RS485 communication:

- A special RS485 Piggy-Back module and appropriate cable glands for all Sunny Boys
- The light blue resistors (**Fig. 6.6**) on the system control board are removed.
- If connected to a PC:

The interface converter RSU485 (ordering no. 39-0020) is available.

Sunny Data visualization software is installed on the PC.

Some PCs have a 25-pole COM port. In this case a small adapter (ordering no. 39-5010) may be necessary.

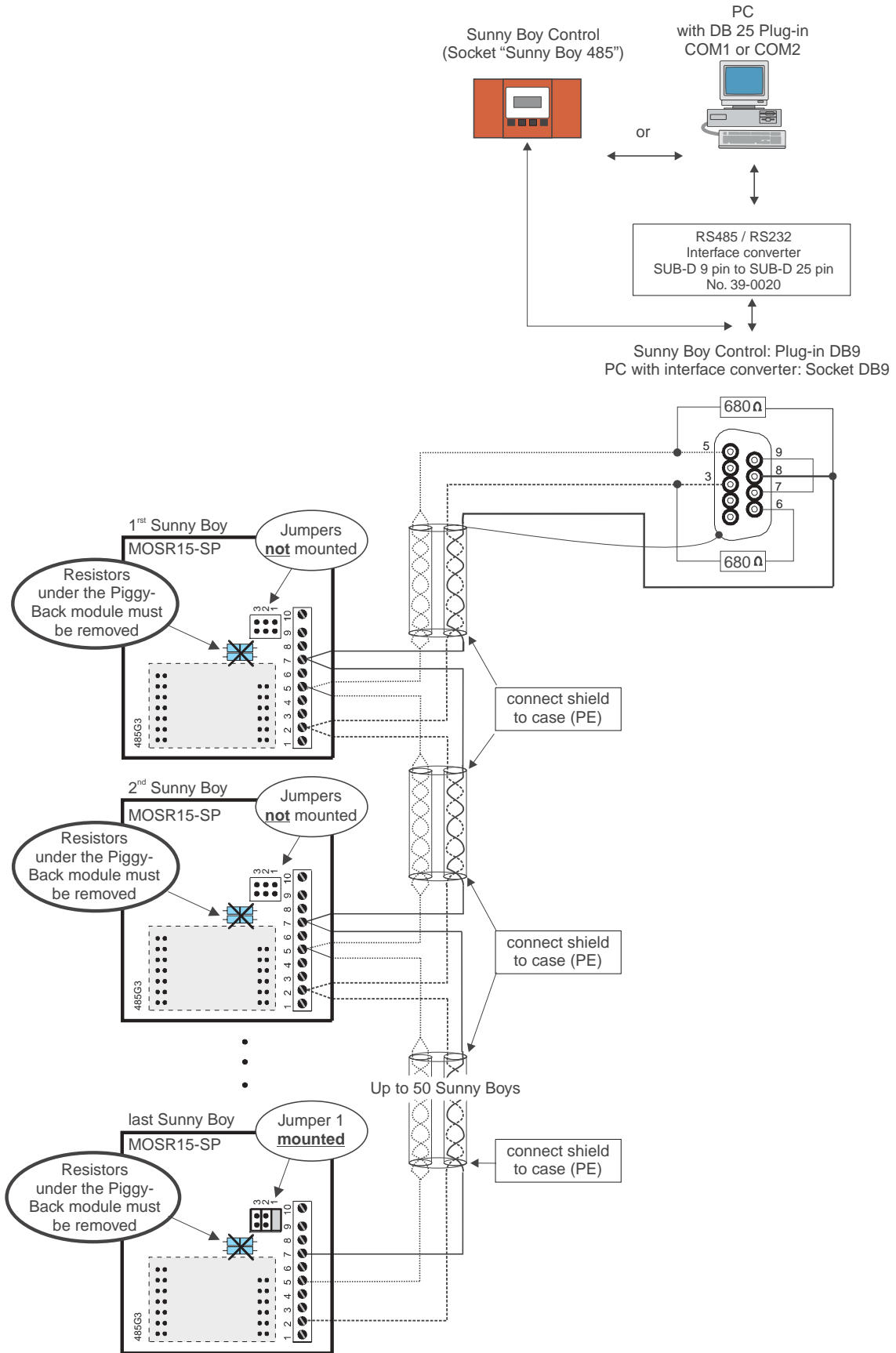

Fig. 6.6: System control board Sunny Boy with RS485 cabling

Installation (RS485)

- Read chapter 6.3.
- Connect pin 7 and pin 9 on the end of the cable that is connected to the interface converter.
- If you are using a PC instead of a Sunny Boy Control, switch the interface converter RS485/RS232 (ordering no. 39-0020) to “DTE“.
- The transmission cable is terminated on the last Sunny Boy on the cable. There a termination resistor is connected by mounting a jumper (no. 1, jumper directly above the terminal strip).
- Two resistors of 680 Ohm each must be integrated into the DB9 connection at the beginning of the cable that is connected to the Sunny Boy Control or the PC. One is soldered from pin 3 to pin 6, the other is soldered from pin 5 to pin 8 (see Fig. 6.6). These resistors are not required for communication with the *Sunny Boy Control* if the corresponding jumpers were plugged on.
- The recommended cable for the RS485 connection is a LIYCY 2 x 0.25 mm twisted pair cable. It consists of four data lines of which two are each combined to altogether two twisted pairs. Both pairs are surrounded by a single common shield. Maximum length of the entire RS485 connection is 1200 m (4000 ft.). It is essential to connect the outer shielding to protective earth (PE) on both ends.
- If necessary an adapter for the RS232 plug from the interface converter to the PC (9-pin to 25-pin)

9-pin to 25-pin adapter

DB9	DB25	Description
1	8	DCD (Data Carrier Detect)
2	3	RX (Receive Data)
3	2	TX (Transmit Data)
4	20	DTR (Data Terminal Ready)
5	7	GND (Signal Ground)
6	6	DSR (Data Set Ready)
7	4	RTS (Request To Send)
8	5	CTS (Clear To Send)
9	22	RI (Ring Indicator)

Table 6.1: Pin designation of the DB9/DB25 adapter

6.3 Upgrading or modification of the Sunny Boy interface

The Sunny Boy is prepared for data transmission. By simply plugging on a piggy back module it supports the RS232 or RS485 interfaces for the Powerline protocol.

In order to install a new interface in the Sunny Boy a corresponding piggy back module has to be installed on the system control board. Please follow all relevant instructions in chapters 3.3, "Electric Connection", 4, "Commissioning", 5.1, "Opening and closing of the Sunny Boy" in the Sunny Boy manual.



The Sunny Boy works with high voltages externally and internally which can cause considerable harm to people. Only a qualified electrician may work on the device, especially open it!

While upgrading the Sunny Boy interface the operator can get into touch both with electronic components and components carrying lethal voltage. Faulty upgrading can lead to damage at the device and danger to people by electric voltage.

Therefore the device may only be upgraded by qualified personnel or the SMA service.



Only work on the Sunny Boy when it is disconnected from the grid and sufficiently discharged!

Follow ESD protection countermeasures when modifying the Sunny Boy:

Electronic components are sensitive to electrostatic discharge. To protect them you have to be on the same electric potential. Discharge the electrostatic charge by touching the grounded case before touching an electronic component, otherwise you take a great risk in destroying your electronics.

Open the device as described in chapter 5.1.

Remove the piggy back that is installed on the system control board.

- Only for installation of an RS232 or RS485 board:
 - Remove the light blue resistors (Fig. 6.6) on the system control board by cutting them out with a wire cutter.
- Only for installation of a board for Powerline Communication:
 - Please make sure that the light blue resistors (Fig. 6.6) are plugged onto the system control board. If not, resistors (corresponding to 0 Ohm resistors) have to be installed in there.

Plug the desired piggy back module onto the required slot. When plugging on the piggy back please make sure no socket of the piggy back plug-in contacts remains open.

Connect the cables for RS232 (see Fig. 6.3) or RS485 (see Fig. 6.6). No cabling is necessary for Powerline communication. Data cables are lead outside through the free opening at the bottom of the Sunny Boy. Please insert the PG16 screws into this opening and fasten them.

- Lead the communication cable through the contact unit of the PG cable gland.
- Connect the terminal cables to the terminal strip of the system control board and check whether they are firmly fastened.
- Fasten the cable seal of the PG16 cable gland.
- If you have installed RS232 cabling please close the opening in the bottom with the seal included in the packing list.
- Close the device as described in chapter 5.1.

6.4 Graphic User Interface under Windows

Sunny Data

Sunny Data is used in order to establish a communication between a PC and your Sunny Boys and process and evaluate data from these. It provides a graphic user interface with all positive features known under Windows.

The available measurement channels of the Sunny Boy (see chapter 6.5) can be displayed online. The data can be displayed manually or automatically. The data is stored in files on any available storage medium. Special functions allow the installer to modify the operating parameters of the Sunny Boy in order to improve system performance. Please see the Sunny Data manual for further information on Sunny Data.

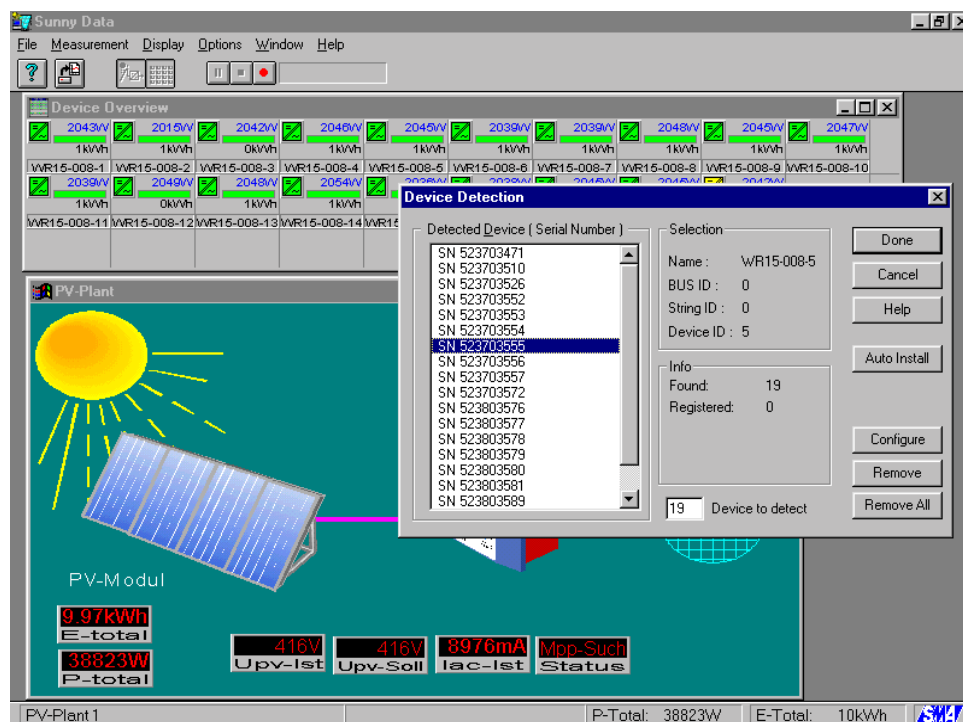

Fig. 6.7: Sunny Data user interface

Sunny Data Control

Large PV-plants with numerous Sunny Boys are supervised and monitored with a Sunny Boy Control. The Sunny Boy Control handles central measurement data acquisition and diagnosis for up to 50 Sunny Boys and assists the commissioning of the PV-plant. Additional features are remote diagnosis via modem and fax messages.

For global visualization of PV plant data SMA offers the Sunny Data Control PC software under Windows. E.g. the power output of the entire large-scale PV-plant can be shown in a matrix.

For the numerous possibilities of establishing a monitoring concept with Sunny Boy Control please see the Sunny Boy Control manual.

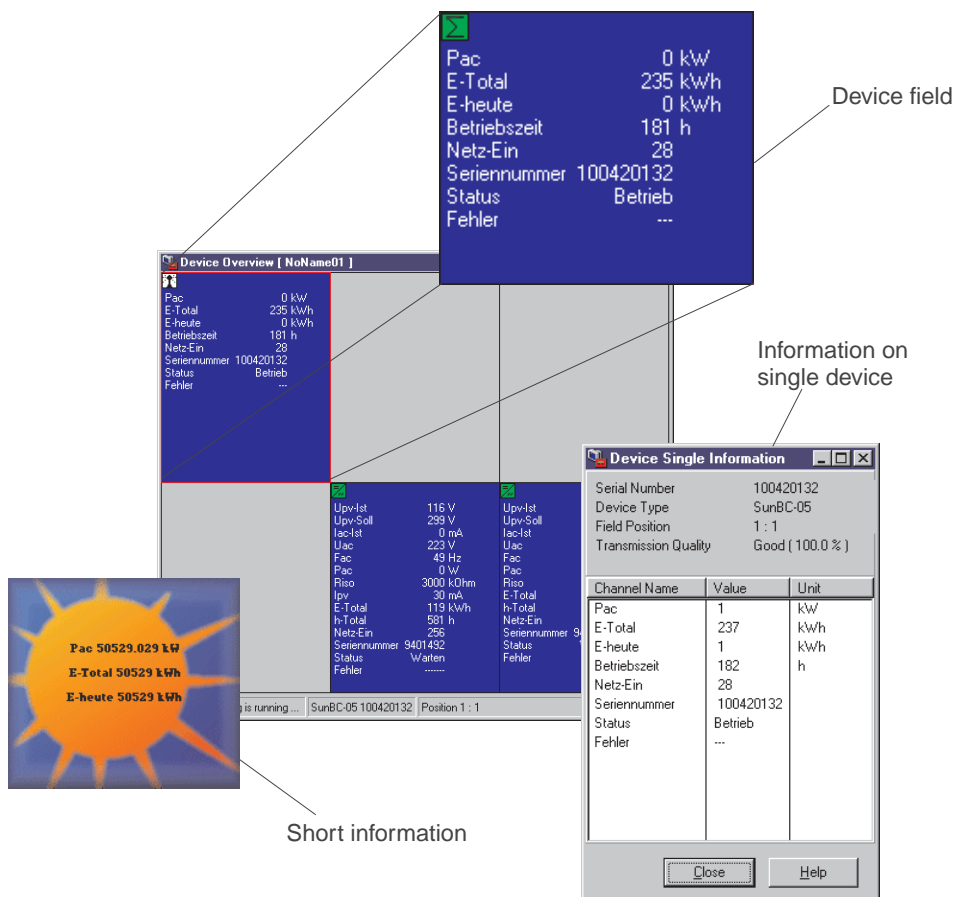

Fig. 6.8: Sunny Data Control graphic user interface

6.5 Measuring Channels and Messages of the Sunny Boy

If your PC is equipped with communication (see chapter 2.2), it supports a number of measuring channels and messages from the Sunny Boy inverters and transmits them to the output unit for diagnosis.

The following abbreviations are used:

BFR	B etriebsföhrungsrechner (Sequential Control System)
SRR	S tromregelungsrechner (Current Control System)

Measuring Channels

Upv-Ist	PV-input voltage
Upv-Soll	PV-desired voltage of the internal Upv-control
Iac-Ist	current to the grid
Uac	grid voltage
Fac	grid frequency
Pac	power fed to grid
Zac	grid impedance
Riso	isolation resistance
Ipv	current from PV-panels
E-Total	energy yield
h-Total	total operation hours
Netz-Ein	total system start ups
Seriennummer	Sunny Boy serial number
Status	status
Fehler	failure description for status "failure"

Status Messages

Stop	manual system stop
Offset	offset calibration of the electronics
Warten	grid conditions are not fulfilled (yet)
Netzueb.	checking grid (grid impedance)
Zuschalt	electronics are connecting to grid
MPP-Such	PV voltage is determined and set
MPP	Sunny Boy is in MPP mode
U-Konst.	Sunny Boy is in constant voltage mode
Derating	Reduction of current fed to the grid
Stoer.	failure

Error messages

F-Bfr-Srr	communication between microcontrollers is failing
F-EEPROM	EEPROM cannot be read or written in
F-EEPROM dBh	EEPROM cannot be read or written in
F-Fac-Bfr	BFR-frequency measurement - value out of tolerable range
F-Fac-Srr	SSR-frequency measurement - value out of tolerable range
F-dZac-Bfr	BFR-sudden change of impedance - value out of tolerable range
F-dZac-Srr	SSR-sudden change of impedance - value out of tolerable range
F-Imax	internal overcurrent
F-NUW-UAC	different values between BFR and SRR for grid voltage
F-NUW-FAC	different values between BFR and SRR for grid frequency
F-NUW-Mess	different values between BFR and SRR for Vac, fac and Zac
K1-Schliess	Relay test failed
K1-Trenn	Relay test failed
F-NUW-ZAC	different values between BFR and SRR for grid impedance
F-Offset	Offset check for grid voltage or power measurement failed
F-Rechner	BFR or SSR controller failure
F-Riso	isolation resistance out of tolerable range
F-Uac-Bfr	BFR-grid voltage measurement - value out of tolerable range
F-Uac-Srr	SSR-grid voltage measurement - value out of tolerable range

F-UpvMax	PV input voltage above the tolerable maximum value
F-Zac-Bfr	BFR-grid impedance measurement - value out of tolerable range
F-Zac-Srr	SSR-grid impedance measurement - value out of tolerable range
F-Watchdog	Watchdog for operation control triggered
F-ROM	Failure during ROM test

6.6 Measurement Precision

Any kind of measurement always depends on the accuracy. The measurements taken by the Sunny Boy are required for its operational control and the control unit of current to be fed to the grid. The reproducibility of measurement values is conceived for these requirements. A maximum measurement error is conceived for an ambient temperature ϑ_U of 25 °C. Other temperatures must be evaluated with respect to the inaccuracy resulting from these different temperatures.

	[Unit]	Range	Resolution		Maximal failure $\vartheta_U=+25^\circ\text{C}$
			Display	Measurement	
Input voltage	U_{PV} [V]	0...650 V	1 V	1.12 V	±2%
Input current	I_{PV} [mA]	0...12000 mA	1 mA	12 mA	±4%
Grid voltage	U_{AC} [V]	190...300 V	1 V	0,3 V	±1%
Grid current	I_{AC} [mA]	0...15000 mA	1 mA	30 mA	±2%
Grid frequency	f_{AC} [Hz]	45...65 Hz	0,01 Hz	0,01 Hz	±0.1%
Output power	P_{AC} [W]	0...3000 W	1 W	1 W	±3%
Energy yield	E [kWh]	0...4.29*10 ⁹ Wmin	1 Wmin	20 Wmin	±3%
Operating hours	h [h]	0...4.29*10 ⁹ s	1 s	0.67 μs	±0.1%

Table 6.2: Measurement accuracy of the Sunny Boy

7 Troubleshooting

Our quality management strategy includes a constant quality improvement of our products. We always are concerned to avoid all failures and malfunctions of our products.

The product you purchased was shipped after successfully passing numerous tests concerning the operation behavior, the disconnection devices and a long term heavy duty tests.

We recommend to conduct the following steps in case your PV-plant does not operate correctly:

- Check the blink code on the lid of the Sunny Boy and compare the code with the blink codes listed in chapter 5. Follow the countermeasures listed there, if necessary contact the installer.
- Check the “Status“ and “Failure“ messages in one of the monitoring system described in chapter 6 if present.
- Contact the Sunny Boy service if the system malfunction consists. The address is listed in the appendix.

In order to let your PV-plant operate again as soon as possible it is essential to provide the following information:

- Information concerning the Sunny Boy
 - serial number of the inverter
 - Sunny Boy type
 - short failure description
 - Number of the blink code (see chapter 5)
 - If Sunny Boy Control or a PC with Sunny Data is present: Which status and failure are indicated?
 - Can you reproduce the failure? How can you reproduce it?
 - Does the failure occur sporadically?
 - Has this failure always occurred?
 - What were the ambient conditions when the failure occurred?
- Information concerning the PV-modules
 - Supplier, type of modules
 - Number of modules in string
 - Output power
 - Open circuit voltage

Use the original box the Sunny Boy was delivered in if the Sunny Boy has to be sent to the manufacturer.

8 Warranty Regulations and Liability

If your inverter shows a defect or a malfunction during the warranty period please contact your distributor or installer.

Warranty

The warranty period is **24 months** from the date of purchasing the device by the end user. It ends at the latest 30 months after the delivery date from SMA, and includes all defects caused by material or manufacturing faults.

The guarantee period for warranty repairs or compensation deliveries ends 12 months after delivery, but runs at least until the expiration of the original warranty period for the delivered item.

Evidence

SMA will only render warranty services when the rejected device is sent back to SMA together with a copy of the invoice the distributor has issued for the consumer. The type plate at the device must be fully legible. In case of non-fulfillment SMA reserves the right to refuse warranty services.

Conditions

SMA will decide whether it will repair the device in its works without invoicing material and working costs or deliver a replacement device.

The objected device is to be sent back to SMA in the original packing or in a transport packing of equal quality free of charge. If the warranty applies transport costs will be for SMA's account.

The customer has to grant SMA the necessary time and opportunity to repair the defects.

Exclusion of Liability

Excluded are any warranty claims and liability for direct or consequential damages due to

- transportation damages,
- improper installation or commissioning,
- improper alterations, modification or repairing attempts,
- inappropriate use or operation,
- any installation and operation beyond the specification covered by according relevant safety regulations (VDE etc.),
- or force majeure (lightning, over-voltage, storm, fire).



We cannot guarantee the proper function of the data transmission via mains lead (Powerline-modem) in case it is carried out in electric grids with high harmonic distortion resp. high-frequency line distortions like industrial power supply grids, or in the neighborhood of irregular consumers (unshielded motors, switching power supplies, converters, etc.). Furthermore, the simultaneous operation of babyphones may lead to short-time data transmission disturbances or interruptions. In case of disturbed data transmission via mains lead, we alternatively offer communication via separate data line (RS232 or RS485) (see chapter 6).

We do not guarantee that the software is completely free of failures. In case of a failure an instruction how to avoid the effects of the fault is also considered as sufficient repair. Only the customer is responsible for the correct selection, orderly use, supervision, and the results of the use of software.

We reserve the right to make alterations serving the improvement of the device.

More extensive or other claims for direct or indirect damages, especially including claims for damages from positive contract violation, are excluded insofar as not otherwise compelling stated by law.

9 Technical Data

Input variables (PV modules)

Maximum open circuit voltage of the PV strings



It is essential to check if the PV modules produce a voltage within the specified tolerable input voltage range in their rated temperature range. The maximum open circuit voltage of the connected PV string may not exceed the specified maximum DC input voltage.

The open circuit voltage of the PV panel depends on its cell temperature as well as solar radiation. The maximum open circuit voltage of the PV panel is reached at the lowest cell temperature. Therefore when planning a PV plant take into account the lowest possible ambient temperature of the PV panel. Based on this temperature the maximum open-circuit voltage of the PV panel can be calculated if the type of PV module is known. You can enter these data into our EXCEL[®] file "GenAu" and check whether the maximum admissible input voltage of the Sunny Boy is not exceeded in any possible operating state. You will find this tool in the Internet for download at: <http://www.sma.de/ftp/energietechnik/sunnyboy/GenAu/GenAu.exe>.

Minimum MPP voltage of the PV panel

If the temperature of the PV cells is very high the MPP voltage of the PV panel decreases. If there is a fixed lower limit of the MPP voltage on the inverter it is not possible to feed the maximum available PV panel power to the low-voltage electricity grid. The inverter stays at the lower input voltage limit and cannot follow the MPP of the PV panel any more. Therefore the Sunny Boy has got a flexible MPP voltage range.

There is a fixed ratio of the minimum MPP voltage V_{MPPmin} from the Sunny Boy to the PV panel and the grid voltage V_{AC} as shown in Fig. 9.1. The minimum DC voltage is determined according to the current grid voltage. The flexible MPP voltage range allows for optimum utilization of the inverter's characteristics and a higher power yield.

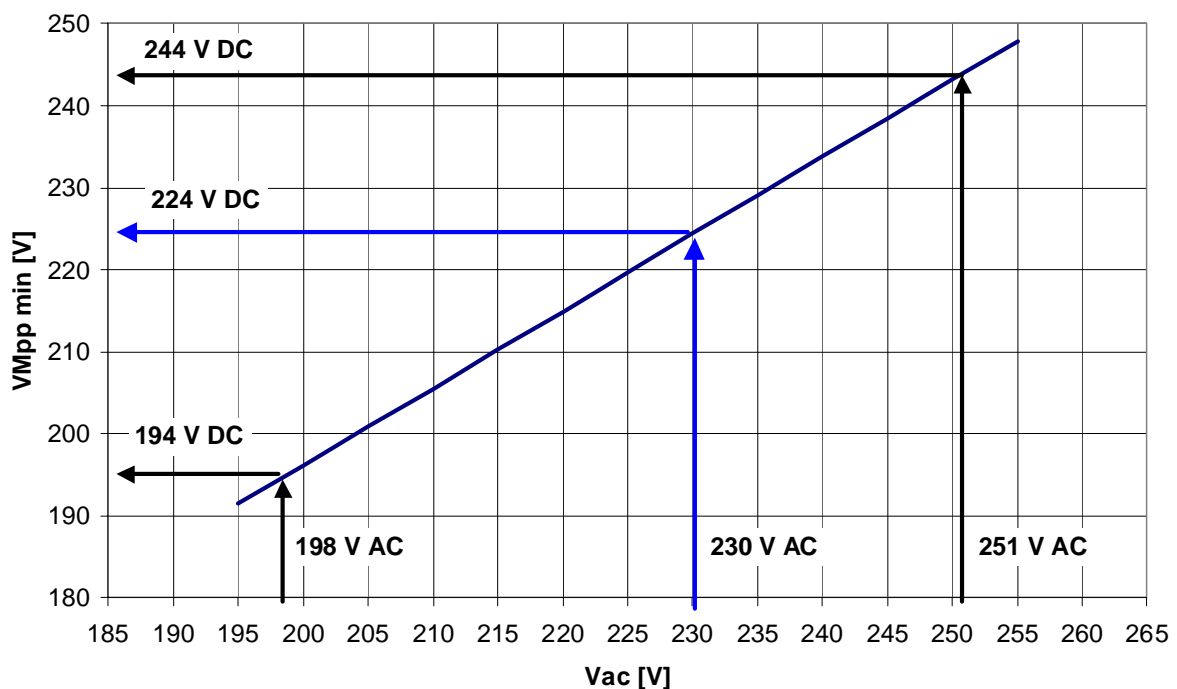

Fig. 9.1: Minimum MPP voltage of the Sunny Boy 2500



According to Fig. 9.1 a grid voltage of $V_{AC} = 230 \text{ V}$ results in a minimum MPP voltage V_{MPPmin} of 224 V.



At +70 °C the MPP voltage of the connected strings may not fall below the respective input voltage range

($V_{MPP+70^\circ\text{C}} > \text{min. input voltage range}$).

Max. input open circuit voltage:	V_{PV0}	600 V DC
Input voltage, MPP range:	V_{PV}	224 V [*] to 550 V DC
Max. input current:	I_{PVmax}	12.0 A
Max. input power:	P_{PV}	2700 W
Recommended max. PV power:	P_{PVmax}	3450 W _p

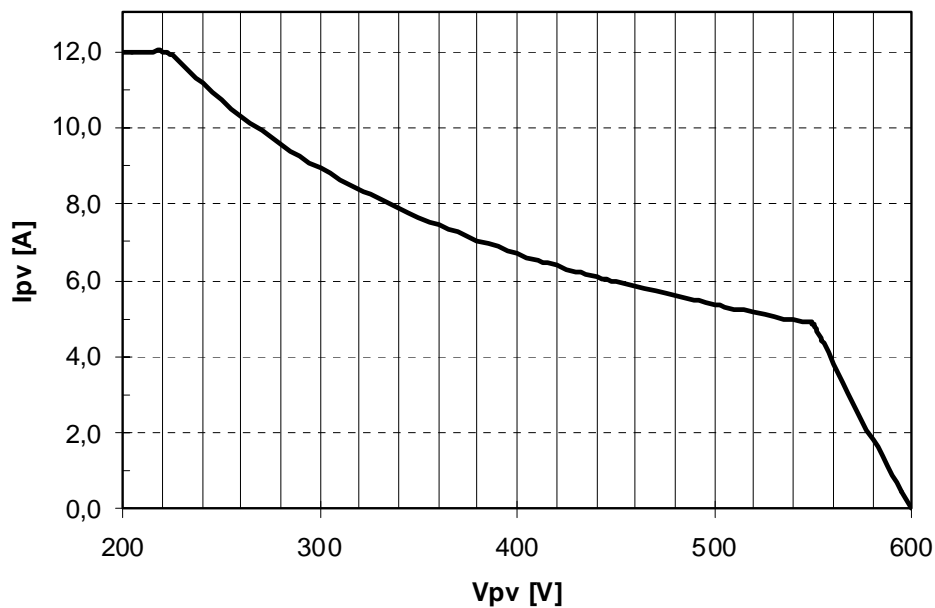

Fig. 9.2: Input current as a function of input voltage of the *Sunny Boy*

^{*} @ V_{ACnom} see p. 71



The inverter is not damaged if the input current supplied by the connected PV panel exceeds the maximum that can be used. However the input voltage has to be within the admissible input voltage range.

All pole disconnection on DC side:

MC plug connector

Over-voltage protection:

thermally monitored varistors

Voltage ripple:

U_{pp} < 10%

Personnel protection:

earth fault monitoring

$(R_{iso} > 1 \text{ M}\Omega)$

Pole confusion prevention:

short circuit diode

Output values (grid)

Nominal power:	P_{ACnom}	2200 W
Peak power:	P_{ACmax}	2500 W
Harmonic distortion of output current: (at $K_{Ugrid} < 2\%$, $P_{AC} > 0,5 P_{ACnom}$)	K_{IAC}	< 4 %
Short circuit protection:		grid side, current controlled
Output range, grid voltage:	U_{AC}	198 – 251 V AC
Output range, grid frequency:	f_{AC}	49.8 – 50.2 Hz
All pole disconnection, grid side:		Mains monitoring with allocated switching devices (MSD), double
Phase shift angle: (based on fundamental current)	φ	0°
Over-voltage category:		III
Testing voltage (50 Hz):		1.4 kV (1/5 s piece/type testing)
Surge voltage test (1.2/50 μs):		4 kV (serial interface: 6 kV)

External interfaces

Data transmission via Powerline:		Optional
Data transmission via data cable:		Optional; RS232 / RS485 electrically separated

Efficiency

Max. efficiency:	η_{max}	> 94 %
Euro eta	η_{euro}	> 93 %

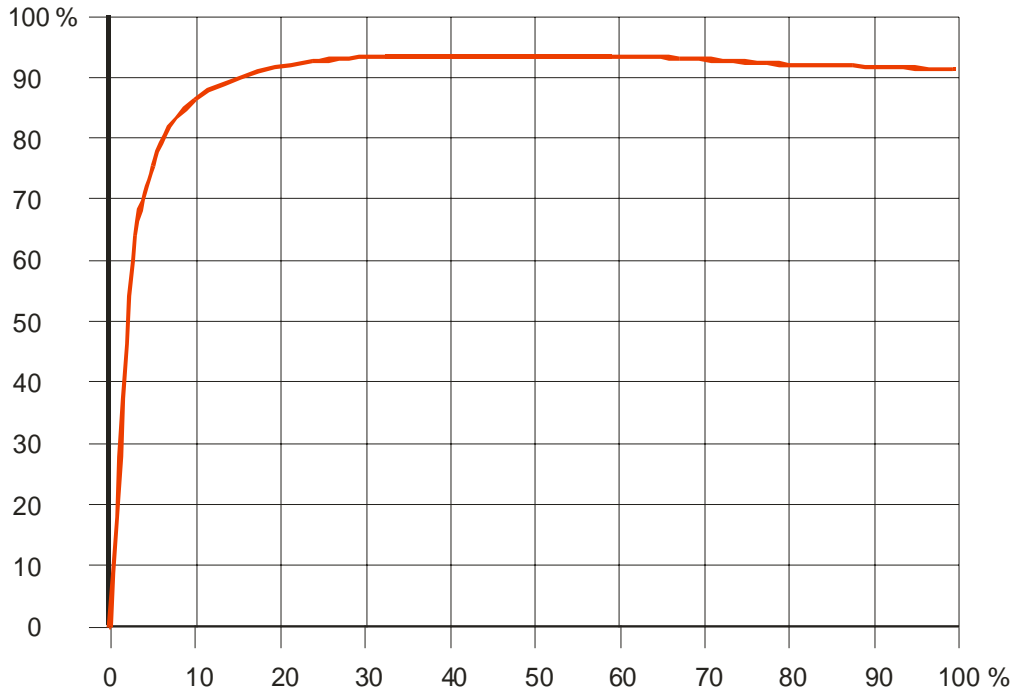

Fig. 9.3: Sunny Boy 2500 efficiency as a function of P_{ac}/P_{acnom}

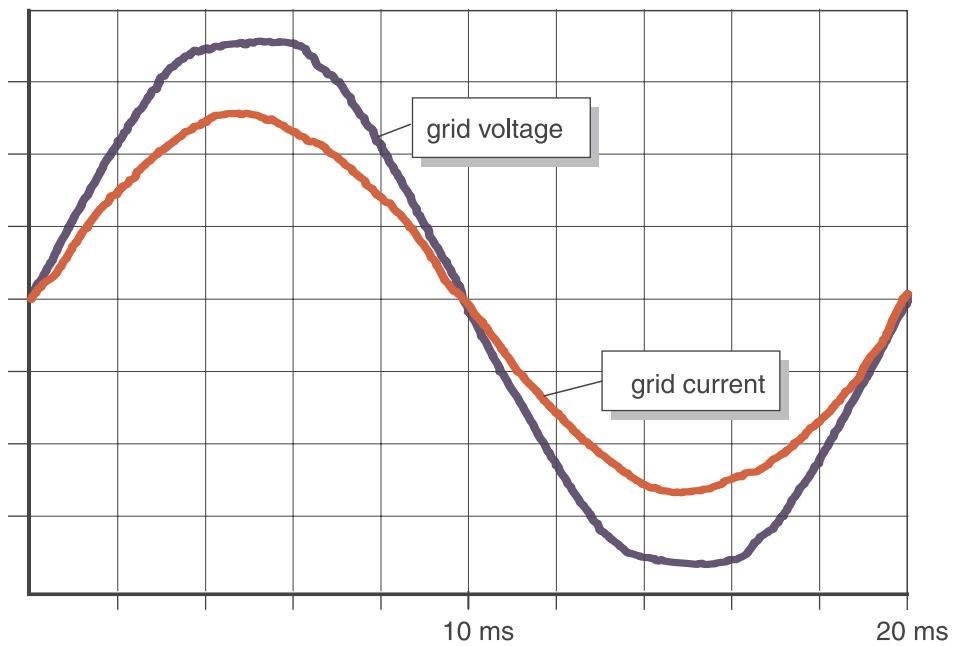

Fig. 9.4: Output current and output voltage of the Sunny Boy

Power consumption**Power consumption during operation:** < 7 W**Power consumption during stand-by:** < 0.25 W**Certifications:****EMC:** DIN EN 50081, part 1
(EN 55014, EN 55011 section 1, class B)
DIN EN 50082, part 1**Grid concurrency:** DIN EN 61000-3-2 (DIN EN 60555 part 2)**Grid monitoring:** Mains monitoring with allocated switching devices (M
in accordance with VDEW
E DIN VDE 0126 (10.97)**Low voltage regulation:** DIN EN 50178 (4.98) (VDE 0160)
DIN EN 60146 part 1-1 (3.94) (VDE 0558 part 11)**Device Protection****Protection in accordance with
DIN EN 60529:** IP65**Weight and Dimensions****Dimensions (w x h x d):** ca. 434 x 295 x 214 mm**Weight:** ca. 30 kg**Ambient Conditions for Operation****Tolerable ambient temperature :** -25 °C to +60 °C**Tolerable relative humidity:** 0 ... 100 %, class 3K6

Parameter List Sunny Boy 2500

All parameters are transmitted to Sunny Data or to the Sunny Boy Control when the Sunny Boy 2500 is configured. The following table shows the available parameters:

Name	Unit	Range		Default (for PV-input voltage)	Changes by ...
		from ...	to ...		
SMA-SN					fixed
Upv-Start*	V	250.0	600.0	300.0	Installer
T-Start	S	5.0	300.0	10.0	Installer
T-Stop	S	1.0	1800.0	2.0	Installer
Usoll-Konst	V	250.0	600.0	600.0	Installer
P limit	W			2500	Fixed
I-NiTest	mA	0	15000	8000	Installer
Uac-Min	V	180	300	198	Installer
Uac-Max	V	180	300	251	Installer
Fac delta-	Hz	0	4,5	0.19	Installer
Fac delta+	Hz	0	4,5	0,19	Installer
d Fac-Max	Hz/s	0.005	4	0.25	Installer
Zac-Max	mOhm	0	20000	1700	Installer
dZac	mOhm	0	2000	350	Installer
Hardware-BFS	Version				Fixed
Software-BFR	Version				Fixed
Software-SRR	Version				Fixed
Operation mode				Mpp-mode	Installer
Memory function				None	Installer
Default				GER / MSD	Installer
Storage				Permanent	Installer

Table 9.1: Parameter list Sunny Boy 2500

These parameters are subject to change due to improvement of the device.

10 Appendix

Certificates for the Sunny Boy 2500

- SMA Declaration of Conformity for the Sunny Boy 2500
- Clean Report of Findings for MSD in the Sunny Boy 2500

Information about SMA

Further literature about the Sunny Boy inverter family²:

- Technical Description Sunny Boy 700/850
- Technical Description Sunny Boy 1100E
- Technical Description Sunny Boy 1700E
- Technical Description Sunny Boy 2000
- Technical Description Sunny Boy 3000
- User Manual Sunny Data
- User Manual Sunny Data Control
- User Manual Sunny Boy Control
- User Manual SWR-COM Socket Powerline Modem
- Sunny Boy Info (periodical newsletter with up-to-date information on the Sunny Boy)
- SMA CD (products, technical documentation, driver)
- Manual "Improved Powerline Communication with the Sunny Boy Family"

² This literature can be ordered from SMA for a small fee - most of this although is available free of charge for download from WWW.SMA.DE .

Sunny Boy in the Internet:

You can find our Internet website at [HTTP://WWW.SMA.DE](http://www.sma.de).

- The latest information concerning the Sunny Boy inverter family.
- The newest Sunny Data software for downloading.
- You can leave messages for SMA. This is especially useful if you want to send data recorded from your PV-plant to the Sunny Boy service.

Those who want to know more about SMA Regelsysteme GmbH and its products are very welcome to visit us on our homepage.

- Address: **SMA Regelsysteme GmbH**
Hannoversche Straße 1-5
D-34266 Niestetal
 - Telephone: 0561/9522-0 (operator)
0561/9522-499 (Sunny Boy Service)
 - Telefax: 0561/9522-100 (main fax)
0561/52035-55 (Sunny Boy Service)
 - eMail: info@sma.de
- Internet: <http://www.sma.de>

Appendix: drilling template